

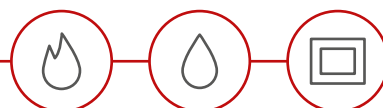

## CATALOGO GENERALE PRODOTTI A LEGNA

MAIN CATALOGUE Wood Products



**ATTENZIONE**

Gentile Cliente,  
tutti i rivenditori La NORDICA-EXTRAFLAME sono al suo servizio per fornirle qualsiasi consiglio ed informazione tecnica indispensabile a scegliere la cucina o stufa a legna che potrà soddisfare le sue esigenze. Prima dell'acquisto richieda sempre al suo rivenditore di fiducia La NORDICA-EXTRAFLAME di poter consultare il LIBRETTO D'ISTRUZIONI, inserito in tutti i prodotti dove sono illustrati tutti i dati relativi alla corretta installazione e successivo utilizzo dei nostri prodotti.  
Grazie per averci preferito.

**ATTENTION**

Dear customer,  
All La NORDICA EXTRAFLAME dealers are at your service to provide the advice and technical information you need to choose a wood burning range or stove to satisfy your needs. Before making your purchase, always ask your local La NORDICA EXTRAFLAME dealer to let you consult the INSTRUCTIONS included in all products giving complete information on correct installation and use of our products.  
Thank you for choosing our company.

**ATTENTION**

Cher client,  
Les revendeurs La NORDICA-EXTRAFLAME sont à votre service pour vous fournir tous les conseils et informations techniques indispensables pour choisir la cuisinière ou le poêle à bois qui pourra répondre à vos besoins. Avant l'achat demandez à votre revendeur La NORDICA-EXTRAFLAME de consulter la NOTICE D'INSTRUCTIONS, qui donne toutes les informations utiles pour une bonne installation et utilisation de nos produits.  
Merci de nous avoir choisis.

**ACHTUNG**

Sehr geehrter Kunde,  
alle La NORDICA-EXTRAFLAME-Fachhändler stehen mit Ratschlägen und technischen Informationen zu Ihrer Verfügung, um Ihnen dabei zu helfen, den Herd oder Ofen auszusuchen, der Ihren Ansprüchen am besten gerecht wird. Bitte Sie vor dem Kauf Ihren La - Fachhändler immer, die GEBRAUCHSANWEISUNGEN einsehen zu können, die allen Modellen beiliegen, wo alle entsprechenden Daten für eine korrekte Installation und den nachfolgenden Gebrauch unserer Produkte aufgeführt sind. Wir danken Ihnen für das entgegengebrachte Vertrauen.

**ATENCIÓN**

Estimado Cliente,  
todos los revendedores de La NORDICA-EXTRAFLAME están a su servicio para ofrecer cualquier consejo y la información técnica indispensable para elegir la cocina o la estufa a leña que satisfaga sus exigencias. Antes de comprar solicite siempre a su revendedor de confianza de La NORDICA-EXTRAFLAME la posibilidad de consultar el MANUAL DE INSTRUCCIONES, incluido en todos los productos, donde se ilustran todos los datos relativos a la instalación correcta y posterior uso de nuestros productos.  
Gracias por habernos elegido.

# TECNOLOGIA

Technology / Technologie / Technologie / Tecnología

**N.B.:** Le caratteristiche tecniche vanno verificate per ogni singolo prodotto - The technical characteristics must be verified for each individual product - Les caractéristiques techniques sont vérifiées pour chaque appareil - Die technischen Eigenschaften sind für jedes einzelne Produkt zu prüfen - Las características técnicas se verifican para cada uno de los productos



## ASC Active System Combustion

È un particolare sistema di connessione che permette di prelevare dall'esterno l'aria di combustione dell'apparecchio.

## ASC Active System Combustion

It is a particular connection system that allows the appliance combustion air to be taken from the outside.

## ASC Active System Combustion

System de raccordement particulier qui permet de prélever l'air de combustion de l'appareil à l'extérieur.

## BBC Bring the Breath into the Combustion

Sistema di prese d'aria che preleva dall'esterno l'aria fresca per la combustione immettendola direttamente nell'apparecchio.

## BBC Bring the Breath into the Combustion

Air intakes system that takes combustion fresh air from the outside leading it directly into the appliance.

## BBC Bring the Breath into the Combustion

Système de prises d'air qui prélève à l'extérieur l'air frais pour la combustion et l'introduit directement dans l'appareil.

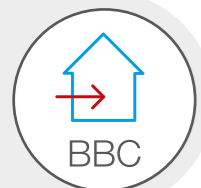

## PCS Post Combustion System

Il sistema di combustione sviluppato da La Nordica-Extraflame consente, grazie ad un sistema di aria secondaria/terziaria, una post combustione in grado di abbattere drasticamente le emissioni.

## PCS Post Combustion System

The combustion system developed by La Nordica allows, due to a secondary/tertiary air system, a post combustion which significantly reduces emissions.

## PCS Post Combustion System

Le système de combustion développé par La Nordica-Extraflame permet, grâce à un système d'air secondaire/tertiaire, une post-combustion en mesure de réduire drastiquement les émissions.



## DSA Dispositivo Sicurezza Automatico

È un dispositivo di sicurezza per l'abbattimento repentino della temperatura dell'acqua secondo le normative vigenti. Valvola DSA optional.

## DSA Automatic Safety Device

It is a safety device created to quickly reduce water temperature, according to rules in force. DSA valve not included.

## DSA Automatic Safety Device

C'est un dispositif de sécurité permettant de diminuer rapidement la température de l'eau selon les normes en vigueur. Soupape DSA optionnelle.

## ASC Active System Combustion

Besonderes Verbindungssystem, das das Ansaugen der Verbrennungsluft des Ofens von außen ermöglicht.

## ASC Active System Combustion

Es un particular sistema de conexión que permite de retirar desde el externo el aire de combustión del aparato.

## BBC Bring the Breath into the Combustion

Ein Luftzufuhrsystem, das Frischluft für die Verbrennung von außen bezieht und direkt in das Gerät einleitet.

## BBC Bring the Breath into the Combustion

Sistema de toma de aire que retira desde el externo aire fresco para la combustión guiándola directamente en el aparato.

## PCS Post Combustion System

Das von La Nordica-Extraflame entwickelte Verbrennungssystem ermöglicht dank eines Zweiluft-/Drittluftsystems eine Nachverbrennung, die die Emissionen beträchtlich reduziert.

## PCS Post Combustion System

El sistema de combustión desarrollado por La Nordica-Extraflame permite, gracias a un sistema de aire secundario/terciario, una post combustión capaz de bajar drásticamente las emisiones.

## DSA Automatic Safety Device

Sicherheitsvorrichtung für die plötzliche Senkung der Wassertemperatur gemäß den geltenden gesetzlichen Bestimmungen. DSA Sicherheitsventil OPTIONAL.

## DSA Automatic Safety Device

Es un dispositivo de seguridad para bajo repentino de la temperatura de el agua según las normativas en curso. Válvula DSA opcional.



## CGC Clean Glass Control

È un sistema che tramite uno specifico percorso d'aria preriscaldato evita efficacemente la formazione di depositi sul vetro della porta fuoco.

## CGC Clean Glass Control

A system of preheated air which removes any deposits from forming on the hearth door glass.

## CGC Clean Glass Control

C'est un système qui grâce à un parcours spécifique d'air préchauffé évite efficacement l'encrassement de la vitre du foyer.



## RDT Resistant Door at the Time

Le porte dei prodotti La Nordica-Extraflame sono realizzate in ghisa di qualità elevata.

## RDT Resistant Door at the Time

La Nordica-Extraflame appliances doors are manufactured in high quality cast iron.

## RDT Resistant Door at the Time

Les portes des produits La Nordica-Extraflame sont réalisées en fonte de haute qualité.



## PRS Power Radiant System

Sistema scambiatore ad altissima efficienza di cessione del calore in ambiente.

## PRS Power Radiant System

Exchanger System at high efficiency of warmth releasing to the room.

## PRS Power Radiant System

Système échangeur à haute efficacité qui assure une transmission de chaleur à l'air ambiant.



## Nordiker

La Nordica-Extraflame, per la realizzazione dei refrattari sulle pareti del focolare, utilizza un particolare materiale denominato Nordiker.

## Nordiker

La Nordica-Extraflame uses a special material called Nordiker for the production of hearth walls refractories.

## Nordiker

La Nordica-Extraflame utilise un matériau spécial dit Nordiker pour réaliser les réfractaires des parois du foyer.

## CGC Clean Glass Control

System, das die Schmutzablagerung am Sichtfenster des Feuerraums mittels eines spezifischen vorgeheizten Luftstroms wirksam vermeidet.

## CGC Clean Glass Control

Es un sistema que a través de un específico recorrido de aire pre-calentada evita eficazmente la formación de depósitos sobre el cristal de la puerta del hogar.

## RDT Resistant Door at the Time

Dieses Material, auch bei hohen thermischen Entspannung untergezogen, unterliegt keine Ausdehnungen oder Veränderung seiner Form.

## RDT Resistant Door at the Time

Las puertas de los productos La Nordica-Extraflame son realizadas en fundición de alta calidad.

## PRS Power Radiant System

Ein Wärmetauschersystem mit hocheffizienter Abgabe der Wärme an die Umgebung.

## PRS Power Radiant System

Sistema intercambiador de altísima eficiencia para la transferencia del calor en el ambiente.

## Nordiker

La Nordica-Extraflame verwendet für die feuerfesten Wände der Feuerstelle eines bestimmten Materials bezeichnet Nordiker.

## Nordiker

La Nordica-Extraflame, para la realización de los refractarios sobre las paredes del hogar, usa un particular material llamado Nordiker.

# SOMMARIO

ALLE RADICI.....	2	Mamy.....	100	Monoblocco Ghisa 750 - Piano.....	177
LA NOSTRA FORZA.....	4	Cucinotta.....	102	Monoblocco Ghisa 750 - Ironker Piano.....	178
I MATERIALI.....	6	Vicenza Evo.....	104	<b>RIVESTIMENTI E CORNICI.....</b>	<b>180</b>
LE CERTIFICAZIONI.....	8	Verona.....	106	Rivestimento Arno.....	182
IL FUTURO RESPIRA LE NOSTRE SCELTE..	10	Verona XXL.....	<b>NEW 2020</b> 108	Rivestimento Astico.....	183
<b>STUFE A LEGNA.....</b>	<b>12</b>	Padova.....	110	Rivestimento Aniense.....	184
Flò.....	14	Rosa XXL.....	112	Rivestimento Linear.....	185
Wanda Evo.....	16	Rosa XXL - Maiolica.....	114	Rivestimento Asiago.....	186
Wanda Classic Evo.....	18	Rosa XXL - Petra.....	116	Cornice Maiolica.....	187
Zen.....	20	Rosa L.....	118	Cornice Origami.....	188
Helga Evo.....	22	Rosa Reverse.....	120	Cornice Steel.....	189
Giulietta X 4.0.....	24	Rosa Sinistra Reverse.....	122	Cornice Wendy.....	190
Isetta con cerchi Evo 4.0.....	26	Rosa 4.0.....	124	Cornice Inox.....	191
Isetta Evo 4.0.....	28	Rosa 4.0 - Maiolica.....	126	<b>TERMOSTUFE.....</b>	<b>192</b>
Isotta con cerchi Evo.....	30	Rosetta Bll.....	128	TermoNathalie DSA.....	194
Isotta Evo.....	32	Rosetta Bll - Maiolica.....	130	TermoRossella Plus Evo DSA.....	196
Isotta Forno Evo.....	34	Rosetta Sinistra Bll.....	132	TermoRossella Plus Forno DSA.....	198
Jennifer.....	36	Family 4,5.....	134	TermoNicoletta Evo DSA.....	200
Jennifer PRS.....	38	Family 3,5.....	136	TermoNicoletta Forno DSA.....	202
Marlena.....	40	Sovrana Evo 2.0.....	138	Loriet S DSA.....	204
Candy 4.0.....	42	Sovrana Easy Evo.....	140	Termolsotta DSA.....	206
Brigitta GB.....	44	Romantica 3,5 - Romantica 4,5.....	142	TermoCucinotta Evo DSA.....	208
Stefany Forno Bll.....	46	<b>CAMINETTI.....</b>	<b>144</b>	Norma S Idro DSA.....	210
Svezia New Bll / Norvegia New Bll.....	48	Insero 60 - Ventilato.....	148	Norma S Evo Idro DSA.....	212
Emiliana.....	50	Insero 60 4.0 - Ventilato.....	149	Norma Classic S Evo Idro DSA.....	214
Fedora.....	52	Insero 70 - Ventilato.....	150	Norma Steel S Evo Idro DSA.....	216
Nicoletta.....	54	Insero 70 4.0 - Ventilato.....	151	<b>TERMOCUCINE.....</b>	<b>218</b>
Nicoletta Forno Evo.....	56	Insero 70 4.0 Tondo - Ventilato.....	152	TermoSovrana DSA.....	220
Gaia.....	58	Insero 70 H49 - Ventilato.....	153	TermoRosa DSA.....	222
Gaia Forno.....	60	Insero 70 H49 4.0 - Ventilato.....	154	TermoRosa XXL DSA.....	224
Gisella.....	62	Insero 70 L - Ventilato.....	155	TermoSuprema Compact DSA.....	226
Asia Bll.....	64	Insero 70 L 4.0 - Ventilato.....	156	Modulo All Inclusive Universale DSA 2.0.....	228
Ester Bll.....	66	Insero 50 Verticale Crystal Bll - Ventilato.....	157	<b>TERMOCAMINI.....</b>	<b>230</b>
Ester Forno Evo.....	68	Insero 70 Crystal - Ventilato.....	158	Focolare 80 Idro Crystal DSA.....	231
Mariarosa.....	70	Insero 80 Crystal Evo 2.0 - Ventilato.....	159	TermoCamino WF25 X - DSA.....	232
Mariarosa - Maiolica.....	71	Insero 80 High Pressure.....	160	TermoCamino WF Plus DSA.....	233
Rossella R1 Bll.....	72	Insero 80 PRS Crystal - Ventilato.....	162	<b>CALDAIE.....</b>	<b>234</b>
Rossella Plus.....	74	Insero 100 Crystal - Ventilato.....	163	Caldaie Serie LNK.....	236
Rossella Plus Forno Evo.....	76	Insero 70 Crystal 3 Lati.....	164	<b>ACCESSORI.....</b>	<b>242</b>
Fulvia.....	78	Insero 70 Crystal Angolo.....	165	<b>SAPER SCEGLIERE.....</b>	<b>254</b>
Fulvia Forno.....	80	Insero 70 Wide.....	<b>NEW 2020</b> 166		
Dorella L8 X.....	82	Insero 70 PRS Wide.....	<b>NEW 2020</b> 167		
Gemma.....	84	Insero 80 Wide.....	168		
Gemma Forno.....	86	Insero 80 PRS Wide.....	169		
Tea.....	88	Insero 100 Wide.....	170		
Super Max.....	90	Focolare 60 Piano Evo.....	171		
Super Junior.....	91	Focolare 70 Piano Evo Crystal.....	172		
Mignon.....	92	Focolare 70 Piano.....	173		
<b>CUCINE.....</b>	<b>94</b>	Focolare 80 Bifacciale Hybrid.....	174		
America.....	96	Focolare 100 Bifacciale.....	175		
Suprema.....	98	Monoblocco 800 Angolo Sx.....	176		
		Monoblocco 800 Angolo Dx.....	176		

# ALLE RADICI

History / L'histoire / Geschichte / La Historia

## La Nordica-Extraflame da 50 anni Riscalda la Vita

C'è il lavoro e c'è la passione. C'è una famiglia e c'è l'ideale. Ci sono l'ottimismo e la voglia di cambiare, ma sempre nel solco della propria tradizione. C'è tutto questo, ed altro ancora, in un prodotto La Nordica-Extraflame. Lo sanno bene i molti clienti che si affidano a questo grande gruppo diventato ormai sinonimo di calore, affidabilità, sicurezza.

Sono passati cinquant'anni da quando Silvano, Giannino e Giorgio Dal Zotto hanno iniziato questa avventura che oggi la famiglia porta avanti con lo spirito dei nostri tempi, investendo in tecnologia e innovazione. Dagli anni Sessanta ad oggi la produzione di stufe, cucine, caminetti e caldaie a legna e pellet si è trasformata in una grande realtà industriale ma l'amore e la dedizione sono rimasti invariati. Un cammino che negli ultimi cinque decenni ha portato il Gruppo a conquistare un mercato internazionale in più di 50 paesi nel mondo, con un'offerta di oltre 200 prodotti Hi-tech Made in Italy per la produzione di energia per il riscaldamento domestico a biomassa.

Una storia di qualità e incessante rinnovamento, attestata dalle più aggiornate certificazioni internazionali, pone le proposte del Gruppo all'avanguardia nel settore.

La nostra storia è alle radici del nostro futuro.



## La Nordica-Extraflame has been warming your life since the last 50 years

There is a family, ideals, passion, work and optimism and the desire to evolve, but keeping always our own tradition. This is all you can find in LaNordica-Extraflame products.

The partners are fully aware that this great group is now synonymous of reliability and safety.

It has been passed already fifty years since Mr. Silvano, Mr. Giannino and Mr. Giorgio Dal Zotto began this adventure that today the family is still carrying on always looking forward a new investment in technology and innovation.

From the years 60s till today the production of wood and pellet burning stoves, cookers, fireplaces and boilers has turn into a great industrial reality, but the love and commitment are still the same.

The journey that in the last five decades has allowed the Group to conquer an international market (more than 50 countries worldwide) with a range of over 200 Hi-tech items Made in Italy, for the productions of renewable energy for domestic heating.

A history of quality and never ending innovation, attested by the latest and strictest international certifications, places the Group to be a forefront of the industry.

Our history, our future.

## La Nordica-Extraflame nous réchauffe la vie depuis 50 ans

Il y a le travail et il y a la passion. Il y a une famille et il y a l'idéal. Il y a l'optimisme et l'envie de changer, mais toujours dans le sillon de la tradition. Tout ceci se trouve dans un produit La Nordica-Extraflame. Les clients qui font confiance à ce grand groupe italien le savent bien, devenu désormais synonyme de chaleur, fiabilité, sécurité.

Cinquante ans sont passés depuis que Silvano, Giannino et Giorgio Dal Zotto ont commencé avec cette aventure que la famille continue aujourd'hui avec l'esprit de notre temps, en investissant en technologie et innovation.

Depuis les années soixante jusqu'à ce jour, la production de poêles, de cuisines, de cheminées et de chaudières à bois et à pellets est devenue une grande réalité industrielle, mais l'amour et le dévouement sont restés inchangés.

Un chemin qui au cours des cinq dernières décennies a permis au Groupe de conquérir un marché international dans plus de 50 pays du monde, et une offre de plus de 200 produits Hi-tech Made in Italy pour la production d'énergie pour le chauffage domestique à biomasse.

Une histoire de qualité et une incessante innovation, attestée par les certifications internationales les plus actualisées, placent les propositions du Groupe à l'avant-garde dans le secteur.

Notre histoire est aux racines de notre futur.

## Bereits seit 50 Jahren verleiht La Nordica-Extraflame unserem Leben Wärme

Arbeit und Enthusiasmus. Eine Familie und ein gemeinsames Ideal. Optimismus und Freude an Veränderungen, die eine natürliche Konsequenz der Tradition sind. Alle diese Attribute charakterisieren die Produkte von La Nordica-Extraflame. Und dies wissen die Kunden, die sich dieser großen Unternehmensgruppe, die zu einem Synonym für Wärme, Zuverlässigkeit und Sicherheit geworden ist, anvertrauen. Es sind bereits 50 Jahre vergangen, seitdem Silvano, Giannino und Giorgio Dal Zotto mit diesem Abenteuer begonnen haben, das heute die Familie in Sinne des jetzigen Zeitgeistes mit Investitionen in Technologien und Innovation weiter führt. Seit den sechziger Jahren bis heute hat sich die Fertigung von Öfen, Herden, Kaminen und Heizkesseln für die Brennstoffe Holz und Pellet in einer beachtlichen Industrierealität entwickelt, aber die Liebe und Hingabe sind unverändert geblieben. Auf diesem Weg hat die Unternehmensgruppe in den vergangenen fünf Jahrzehnten den internationalen Markt erobert. Mehr als 200 Hightech-Produkte zur Erzeugung von Wärmeenergie für Wohnräume werden in mehr als 50 Ländern weltweit vertrieben. Qualität und kontinuierliche Innovation als traditionelle Markenzeichen, was durch die neuesten, internationalen Zertifizierungen bestätigt wird, stellen sicher, dass sich das Angebot der Unternehmensgruppe immer in den vordersten Rängen der Branche befindet.

Unsere Geschichte ist das Fundament unserer Zukunft.

## La Nordica-Extraflame calienta la vida desde hace 50 años

Hay trabajo y hay pasión. Hay una familia y hay un ideal. Hay optimismo y ganas de cambiar, pero siempre dentro del surco de nuestra propia tradición. Todo esto, y mucho más, es lo que hay en un producto de La Nordica-Extraflame. Lo saben muy bien los clientes que confían en este gran grupo que ya se ha convertido en sinónimo de calor, fiabilidad y seguridad. Han pasado cincuenta años desde que Silvano, Giannino y Giorgio Dal Zotto empezaron esta aventura, que toda la familia continúa cada día con el espíritu de nuestros tiempos, invirtiendo en tecnología e innovación. Desde los años sesenta hasta hoy la fabricación de estufas, cocinas, chimeneas y calderas de leña y pellets la transformó en una gran realidad industrial, pero el amor y la dedicación han permanecido invariados. Un camino que en las últimas cinco décadas ha llevado al Grupo a conquistar un mercado internacional en más de 50 países en el mundo, con una gama que supera los 200 productos de alta tecnología Made in Italy para la producción de energía para la calefacción doméstica de biomasa. Una historia de calidad e innovación incesante, atestada por las certificaciones internacionales más actualizadas, que pone las propuestas del Grupo a la vanguardia en el sector.

Nuestra historia está en las raíces de nuestro futuro.



## +200 Prodotti innovativi



Oltre 200 articoli per la produzione di energia per il riscaldamento domestico: stufe, caminetti, cucine, termoprodotto e caldaie a legna e pellet. Una proposta di qualità e incessante innovazione che pone il Gruppo all'avanguardia del settore.

## Innovative Products

More than 200 items for the production of energy for domestic heating: stoves, fireplaces, cookers, thermo products and wood and pellet boilers. A high quality, constantly innovative range of products that puts the Group at the forefront of the industry

## Produits Innovants

Plus de 200 articles pour la production d'énergie destinée au chauffage domestique : poêles, cheminées, cuisinières, thermoproduits et chaudières à bois et à granulés. Une offre de qualité, fruit d'une innovation incessante, qui place le groupe à l'avant-garde du secteur.

## Innovative Produkte

Über 200 Artikel zur Erzeugung von Wärmeenergie für Wohnräume: Öfen, Kamine, Herde, Heizgeräte und Heizkessel für Holz oder Pellets. Qualität und ständige Innovation sorgen dafür, dass diese Gruppe eine Spitzenstellung in der Branche einnimmt

## Productos Innovadores

Más de 200 artículos para la producción de energía para la calefacción doméstica: estufas, chimeneas, cocinas, termoproductos y calderas de leña y pellet. Se trata de una propuesta de calidad y una innovación constante que sitúa al Grupo a la vanguardia del sector

## 5 Stabilimenti produttivi



Il Gruppo La Nordica-Extrafame ha raggiunto una prestigiosa posizione internazionale grazie a 5 stabilimenti produttivi rigorosamente Made in Italy.

## Production plants

The La Nordica-Extrafame Group has become a leading international player thanks to its five production plants, with a strictly Made-in-Italy production process.

## Usines de production

Le groupe La Nordica-Extrafame a conquis une position prestigieuse au niveau international grâce à 5 usines de production rigoureusement Made in Italy.

## Fertigungsstätten

Die Gruppe La Nordica-Extrafame hat sich dank seiner fünf Fertigungsstätten ausschließlich Made in Italy international eine angesehene Stellung erarbeitet.

## Plantas de producción

El Grupo La Nordica-Extrafame ha alcanzado una prestigiosa posición internacional gracias a 5 plantas productivas rigurosamente Made in Italy.

## +50 Paesi nel Mondo



La rete commerciale La Nordica-Extrafame può fornire i propri prodotti in oltre 50 paesi esteri.

## Countries in the world

The La Nordica-Extrafame sales network supplies its products to more than 50 countries worldwide.

## Pays Dans le monde

Le réseau commercial de La Nordica-Extrafame lui permet de fournir ses produits dans plus de 50 pays étrangers.

## Weltweit Präsent

Über sein Vertriebsnetz kann La Nordica-Extrafame ihre Produkte in über 50 Länder liefern.

## Países En El Mundo

La red comercial La Nordica-Extrafame puede suministrar sus productos en más de 50 países extranjeros.

## 6 Aule tematiche



Nel Training Center, dotato di 6 aule tematiche, tecnici e incaricati alla vendita sono sottoposti a una formazione costante, per risolvere tutte le necessità dell'utente finale.

## Thematic classrooms

At the Training Centre, featuring 6 thematic classrooms, technicians and sales staff undergo constant training to meet all end user requirements.

## Salles de formation thématiques

Au sein du Training Center, doté de 6 salles de formation, les techniciens et vendeurs bénéficient d'une formation constante afin de répondre à tous les besoins de l'utilisateur final.

## Themen Räume

Im Training Center mit sechs Themen-Räumen werden Techniker und Verkaufspersonal fortlaufend geschult, damit sie die Endkunden optimal beraten können.

## Aulas temáticas

En el Training Center, equipado con 6 aulas temáticas, técnicos y encargados de las ventas reciben una formación constante, para resolver todas las necesidades del usuario final.

## 370 Centri di assistenza tecnica in Europa



Per assicurare interventi rapidi e puntuali sui prodotti, negli anni il Gruppo La Nordica-Extrafame ha realizzato e consolidato sul territorio una capillare rete di tecnici qualificati e autorizzati, costantemente formati sulle novità dei prodotti e dei servizi e in filo diretto con il "Customer Service".

## Technical service centres in Europe

To ensure rapid and timely interventions on products, the La Nordica-Extrafame Group has, over the years, created and consolidated on the territory an extensive network of qualified and authorised technicians, continually trained on new products and services and in direct contact with the "Customer Service".

## Centres d'assistance technique en Europe

Afin d'assurer des interventions rapides et ponctuelles sur les produits, au cours des années, le groupe La Nordica-Extrafame a réalisé et consolidé, sur le territoire, un réseau capillaire de techniciens qualifiés et agréés, constamment formés sur les nouveautés des produits et services et en liaison directe avec le "Customer Service".

## Kundendienststellen in Europa

Um rasche und pünktliche Eingriffe an den Geräten zu gewährleisten, hat die Gruppe LaNordica-Extrafame auf dem gesamten Gebiet ein kapillares Netz von qualifizierten und autorisierten Technikern gegründet, die fortwährend über die neuen Aspekte der Produkte und Dienstleistungen geschult werden und in direktem Kontakt mit dem "Customer Service" stehen.

## Centros de Asistencia técnica en Europa

Para asegurar intervenciones rápidas y puntuales en los productos, a lo largo de los años el Grupo La Nordica-Extrafame ha realizado y consolidado en el territorio una vasta red de técnicos cualificados y autorizados, constantemente formados sobre las novedades de los productos y de los servicios y en línea directa con el "Customer Service".

# MATERIALI

Materials / Les Matériaux / Materialien / Los Materiales

**Ghisa.** La Nordica-Extraflame da sempre utilizza la migliore Ghisa per la produzione dei propri prodotti. Grazie all'elevato coefficiente di tensione termica che permette di mantenere inalterate le forme, la ghisa è il materiale perfetto per le stufe: resistente al calore ed urti, idoneo a cedere il calore diffondendolo a lungo nell'ambiente. Inoltre è assolutamente ecologico poiché completamente riciclabile. Per i prodotti della gamma vengono proposte la finitura smaltata, che garantisce un'estetica con durata illimitata e con minima manutenzione, o verniciata.

**Cast Iron.** La Nordica-Extraflame has always used the best cast iron to make its products. Thanks to its high thermal stress coefficient, cast iron maintains its shape unaltered, making it the perfect material for stoves... resistant to heat and impact and ideal for releasing the heat with prolonged diffusion in the room. It is also completely recyclable and therefore environmentally friendly. Products in the range are available either painted or with a long-lasting enamel finish requiring minimal maintenance.

**Fonte.** La Nordica-Extraflame depuis toujours utilise la meilleure fonte pour la production de ses appareils. Grâce à sa très bonne tenue en fatigue thermique qui permet à la fonte de ne pas se déformer, c'est le matériau idéal pour les poêles: résistant à la chaleur et aux chocs, pouvant transmettre la chaleur en la diffusant lentement dans la pièce. En outre c'est un matériau totalement écologique car entièrement recyclable. Les appareils de la gamme sont disponibles en finition émaillée pour une qualité esthétique illimitée et un entretien minimal, ou peinte.

**Gusseisen.** Seit jeher verwendet La Nordica-Extraflame das beste Gusseisen zur Herstellung seiner Produkte. Dank des hohen Wärmespannungskoeffizienten, der die Formbeständigkeit ermöglicht, ist Gusseisen das perfekte Material für die Ofenherstellung: hitze- und stoßfest und geeignet, Wärme abzugeben und diese für lange Zeit im Raum zu verteilen. Gusseisen ist zudem umweltfreundlich, denn es ist komplett recycelbar. Für die Produktreihe stehen die Ausführungen emailliert (unbegrenzt beständiges Aussehen und minimaler Wartungsaufwand) oder lackiert zur Verfügung.

**Fundición.** La Nordica-Extraflame usa desde siempre la mejor fundición para la fabricación de sus propios productos. Gracias al alto coeficiente de tensión térmica que permite mantener inalteradas las formas, la fundición es el material perfecto para las estufas: resistente al calor y a los golpes, idónea para ceder el calor difundiendo durante mucho tiempo al ambiente. Además es absolutamente ecológica ya que es totalmente reciclable. Para los productos de la gama se proponen el acabado esmaltado, que garantiza una estética de duración ilimitada y con un mantenimiento mínimo, o barnizada.

**Maiolica.** Il lungo ciclo di lavorazione (due settimane) necessario per ottenere una maiolica, pur avvalendosi dei più nuovi supporti tecnologici a garanzia di una qualità totale, deve essere eseguito completamente a mano. Il risultato è che ogni maiolica è un pezzo bellissimo, unico e irripetibile e le particolarità che si potranno riscontrare su ogni singola maiolica quali cavillature, punteggiature ed ombreggiature ne sono la garanzia.

**Majolica.** Although it uses the most up-to-date technology to guarantee total quality, the lengthy production cycle (two weeks) required to obtain majolica, must be performed completely by hand. All majolica is therefore beautiful, unique and unrepeatable, as guaranteed by the details you can observe on each individual piece, such as craquelure, speckling and shading.

**La Faïence.** Le cycle de fabrication assez long (deux semaines), bien que réalisé à l'aide des procédés technologiques les plus récents pour garantir une qualité totale, doit être exécuté entièrement à la main. Le résultat est que chaque faïence est une pièce unique et magnifique, et les craquelures, l'aspect grenelé ou ombré que présente la faïence en sont la garantie.

**Majolika-Kacheln.** Die Majolika-Kachel ist das Ergebnis einer handwerklichen Arbeit von höchster Qualität. Der lange Verarbeitungszyklus (zwei Wochen), der für die Herstellung einer Majolika erforderlich ist, obwohl die neuesten technologischen Hilfsmittel für die Gewährleistung der vollständigen Qualität eingesetzt werden, muss komplett von Hand ausgeführt werden.

**La Mayólica.** El ciclo de elaboración extenso (dos semanas) necesario para lograr una mayólica realizada a mano que, si bien recurre a nuevos soportes tecnológicos, garantiza una calidad absoluta. El resultado es que hoy la mayólica es una pieza hermosa, exclusiva e irreplicable y con características que se podrán encontrar en cada pieza de mayólica como grietas, punteados y sombreados que representan su la garantía.



**Vetro ceramico.** Rispetto al vetro normale il vetroceramico ha un coefficiente di espansione termica pari quasi a zero, così da non deformarsi per effetto del calore e rappresentare un materiale irrinunciabile per tutti i caminetti e stufe, dove trovano applicazione lastre non soltanto piane ma anche angolate, bombate o addirittura tridimensionali ed in varie dimensioni.

**Glass-ceramics.** Compared to normal glass, glass-ceramics have a thermal expansion coefficient of almost zero, they do not therefore distort when heated and represent a fundamental material for all fireplaces and stoves which use not just flat sheets, but also angled, curved or even three-dimensional in various sizes.

**Verre céramique.** Par rapport au verre normal le verre céramique a un coefficient de dilation thermique égal à zéro, donc il ne se déforme pas sous l'effet de la chaleur; c'est un matériau idéal pour toutes les cheminées et poêles où les plaques de verre utilisées ne sont pas toujours planes mais irrégulières, bombées ou même tridimensionnelles et de différentes dimensions.

**Glaskeramik.** Im Vergleich zu normalem Glas besitzt Glaskeramik einen Wärmeausdehnungskoeffizienten fast gleich null, sodass sie sich durch Hitze nicht verformt und ein unverzichtbares Material für alle Kaminöfen und Öfen darstellt, bei denen nicht nur flache, sondern auch gewölbte Elemente und Eckplatten oder sogar dreidimensionale Elemente in verschiedenen Größen eingesetzt werden.

**Cristal cerámico.** Respecto al Cristal normal la vitrocerámica posee un coeficiente de expansión térmica casi igual a cero, lo que hace que no se deforme por efecto del calor y que sea un material ineludible para todas las chimeneas y estufas, en las que hallan aplicación placas no sólo planos sino también angulosas, abombadas o totalmente tridimensionales y en varias dimensiones.

**Nordiker.** Per la realizzazione dei refrattari La Nordica-Extraflame ha depositato il Nordiker, un materiale speciale che grazie alla propria resistenza permette di raggiungere elevate temperature di combustione. Il Nordiker offre sicurezza di utilizzo, semplicità nella manutenzione e lunga durata. È inoltre di per sé indicatore di funzionamento, poiché il mantenimento del colore chiaro non solo esalta la luminosità della fiamma ma indica un corretto utilizzo dell'apparecchio. La scelta di prodotti in Nordiker si traduce per il cliente in un migliore funzionamento, grande resa estetica e in minori emissioni.

**Nordiker.** To make its refractory products, La Nordica-Extraflame has patented Nordiker, a special highly resistant material allowing very high combustion temperatures to be reached. Nordiker is safe to use, easy to maintain and extremely durable. It is also an indication of operation as preservation of the light colour not only shows off the luminosity of the flame to full advantage, but also indicates correct use of the appliance. For customers, choosing a product made from Nordiker means better operation, an attractive appearance and lower emissions.

**Nordiker.** Pour la réalisation des parties réfractaires La Nordica-Extraflame a breveté l'Nordiker, un matériau spécial qui grâce à sa résistance permet d'atteindre des températures de combustion élevées. L'Nordiker offre sécurité d'utilisation, simplicité d'entretien et longévité. Sa couleur claire intensifie la luminosité de la flamme et indique aussi le bon fonctionnement de l'appareil si elle ne se modifie pas. Le choix de produits en Nordiker se traduit pour le client en un meilleur fonctionnement, un excellent rendu esthétique et de faibles émissions polluantes.

**Nordiker.** Die feuerbeständigen Elemente bestehen aus Nordiker, einem von La Nordica-Extraflame konzipierten und als Warenzeichen eingetragenen speziellen Material, das dank seiner Beständigkeit hohe Verbrennungstemperaturen ermöglicht. Nordiker bietet sichere Verwendung, einfache Wartung und lange Haltbarkeit. Das Material liefert zudem einen Hinweis auf den Betrieb, denn wenn es hell bleibt, wird nicht nur die Leuchtkraft der Flamme zur Geltung gebracht, sondern auch angezeigt, dass das Gerät sachgemäß benutzt wird. Produkte aus Nordiker gewährleisten bessere Funktionstüchtigkeit, ansprechende Optik und geringere Emissionen.

**Nordiker.** Para la realización de los refractarios La Nordica-Extraflame ha depositado Nordiker, un material especial que gracias a su propia resistencia permite alcanzar elevadas temperaturas de combustión. Nordiker ofrece seguridad de uso, sencillez en el mantenimiento y larga duración. Es además un indicador de funcionamiento en sí mismo, puesto que el mantenimiento del color claro no sólo exalta la luminosidad de la llama sino que indica el uso correcto del aparato. La elección de productos de Nordiker supone para el cliente un mejor funcionamiento, un gran rendimiento estético y menos emisiones.



# LE CERTIFICAZIONI

Certificates / Les Certifications / Zertifizierungen / Las Certificaciones

## Tecnologia Applicata.

Certificazioni ottenute dai più prestigiosi marchi di qualità internazionali fanno sì che l'acquisto di un prodotto La Nordica-Extrafame diventi una garanzia assoluta sia in Italia che all'estero. Vantare tali marchi significa infatti essere in grado di rispettare i rigorosi dettami di qualità generale, resa termica e il rispetto dei parametri delle emissioni di monossido di carbonio nell'atmosfera richiesti dalle più restrittive normative europee. L'ottenimento di suddetti marchi è stato raggiunto grazie a continue ricerche e controlli effettuati dai tecnici utilizzando gli strumenti più avanzati. L'ininterrotta ricerca e gli innumerevoli test garantiscono un livello di sicurezza assoluto ai prodotti.



## Applied Technology.

When buying a La Nordica-Extrafame product in Italy or abroad, certification with the most prestigious international quality marks provides an absolute guarantee. These marks mean our products comply with the severe general quality and heat output criteria and respect the carbon monoxide emission parameters established by the most rigorous European standards. The marks have been obtained thanks to constant research and testing by our technical team using the most advanced instruments. Uninterrupted research and numerous tests guarantee the absolute safety of our products.

## Technologie Appliquée.

Les certifications et labels obtenus auprès des organismes internationaux les plus prestigieux font que l'achat d'un produit La Nordica-Extrafame devient une garantie absolue aussi bien en Italie qu'à l'étranger. Obtenir ces labels signifie en effet être en mesure de satisfaire aux exigences de qualité générale, rendement thermique et respect des taux d'émissions de monoxyde de carbone dans l'atmosphère, prescrites par les normes internationales les plus exigeantes. Ces labels ont été obtenus grâce à une recherche constante et à des contrôles effectués par nos techniciens à l'aide d'instruments à la pointe de la technologie. La recherche continue et les très nombreux essais garantissent un niveau de sécurité absolu de nos produits.

## Angewandte Technologie.

Zertifizierungen der bedeutendsten internationalen Qualitätsmarken machen den Kauf eines La-Nordica-Extrafame-Produkts zu einer absolut sicheren Angelegenheit, in Italien wie auch im Ausland. Diese Zertifizierungen vorweisen zu können bedeutet, die strengen allgemeinen Vorgaben, was Qualität und Wärmeleistung betrifft, zu erfüllen sowie die von den anspruchsvollsten europäischen Vorschriften verlangten Parameter für die Kohlenmonoxidemissionen in die Atmosphäre einzuhalten. Die genannten Auszeichnungen wurden dank kontinuierlicher Forschungen und Prüfungen durch unsere Techniker und den Einsatz modernster Instrumente erreicht. Stetige Forschung und zahllose Tests garantieren unseren Produkten ein absolutes Sicherheitsniveau.

## Tecnología aplicada.

Las certificaciones obtenidas de las marcas de calidad de mayor prestigio hacen que la adquisición de un producto La Nordica-Extrafame", se convierta en una garantía absoluta tanto en Italia como en el extranjero. Contar con dichas marcas significa ser capaz de respetar las rigurosas disposiciones de calidad general, rendimiento térmico y respeto de los parámetros de emisión de monóxido de carbono a la atmósfera, exigidos por las normas europeas más restrictivas. El haber logrado estas marcas ha sido posible gracias a la constante investigación y a los controles realizados por los técnicos valiéndose de instrumental de vanguardia. Una investigación sin interrupción sumada a innumerables pruebas garantiza el nivel de seguridad absoluto de los productos.

## LABORATORI DI OMOLOGAZIONE

Type Approval Laboratories / Laboratoires D'homologation / Prüfstellen / Las Certificaciones



## EN 13229

Norma Europea di riferimento per inserti e caminetti.  
European reference standard for inset appliances including open fires.  
Norme européenne relative aux inserts et cheminées.  
Europäische Bezugsnorm für Kamineinsätze einschließlich offene Kamine für feste Brennstoffe.  
Norma europea de referencia para insertos y chimeneas.

## EN 13240

Norma Europea di riferimento per stufe a combustibile solido.  
European reference standard for room heaters fired by solid fuel.  
Norme européenne relative aux poêles à combustible solide.  
Europäische Norm für Raumheizer für feste Brennstoffe.  
Norma Europea para estufas con combustible sólido.

## EN 12815

Norma Europea di riferimento per cucine a legna.  
European reference standard for residential cookers fired by solid fuel.  
Norme européenne relative aux cuisinières à bois  
Europäische Bezugsnorm für Herde für feste Brennstoffe.  
Norma europea de referencia para cocinas de leña.

## EN 303-5

Norma Europea di riferimento per le caldaie a legna e pellet.  
European reference standard for heating boilers for solid fuels.  
Norme européenne relative aux chaudières à bois et granulés.  
Europäische Bezugsnorm für Heizkessel für feste Brennstoffe.  
Norma europea de referencia para las calderas de leña y pellet.

## 15a B-VG

Conformità all' art. 15° della legge costituzionale federale Austriaca sulle misure di salvaguardia ambientale.  
Compliance with article 15 of the Austrian federal constitutional law on environmental protection measures.  
Conformité à l'art. 15a de la loi constitutionnelle fédérale autrichienne sur la protection de l'environnement.  
Konformität gemäß § 15 des österreichischen Bundesverfassungsgesetzes über Umweltschutzmaßnahmen.  
Conformidad con el art. 15 de la ley constitucional federal austriaca sobre las medidas de protección medioambiental.



Ente inglese promotore dell'utilizzo sicuro, l'efficiente ed ecologico delle biomasse e di altri combustibili solidi.  
English organisation for safe, efficient and environmentally responsible use of biomass and other solid fuels.  
Organisation anglaise pour une utilisation sûre, efficace et respectueuse de l'environnement de la biomasse et d'autres combustibles solides.  
Englische Organisation für die sichere, effiziente und umweltbewusste Nutzung von Biomasse und anderen festen Brennstoffen.  
Organización inglesa para el uso seguro, eficiente y ecológico de la biomasa y otros combustibles sólidos.

## BImSchV

Regolamento tedesco per il contenimento delle emissioni  
German regulations on controlling emissions  
Règlement allemand pour la limitation des émissions  
Deutsche Verordnung über die Einschränkung der Emissionen  
Reglamento alemán para la reducción de las emisiones.



Marchio di conformità alle norme Europee.  
Mark of conformity to European standards.  
Label de conformité aux normes européennes.  
Konformitätszeichen europäische Normen.  
Marca de conformidad con las normas europeas.



Certificazione rilasciata dall'Ufficio federale tedesco per l'economia e il controllo delle esportazioni per la promozione di un uso efficiente dell'energia della biomassa.  
Certification issued by the German Federal Office for Economics and Export Control to promote the efficient use of biomass energy.  
Certification délivrée par l'Office fédéral allemand de l'économie et du contrôle des exportations pour la promotion d'une utilisation efficiente de l'énergie de la biomasse.  
Zertifizierung vom Bundesamt für Wirtschaft und Ausfuhrkontrolle zur Förderung der effizienten Nutzung von Energie aus Biomasse.  
Certificación entregada por la Oficina federal alemana para la economía y el control de las exportaciones para la promoción de un uso eficiente de la energía de la biomasa.



Marchio francese dell'agenzia (ADEME) per l'ambiente e l'energia. I prodotti certificati "Flamme Verte" garantiscono le migliori performance energetiche e di rispetto ambientale.  
French trademark of the ADEME agency for the environment and the energy. The products "Flamme Verte" approved guarantee the best high energy performances and respect for the environment.  
Label français de l'agence (ADEME) pour l'environnement et l'énergie. Les produits certifiés "Flamme Verte" garantissent les meilleures performances énergétiques et les exigences environnementales.  
Französischer Siegel der Agentur für Umwelt und Energie Ademe. Die zertifizierten "Flamme Verte" Produkte garantieren die beste Energieeffizienz und halten die höchsten Umwelanforderungen ein.  
Marca francés de la agencia (ADEME) para el medio ambiente y la energía. Los productos certificados "Flamme Verte" garantizan el mejor rendimiento de energía y respecto del medio ambiente.



Aria Pulita, la certificazione volontaria italiana per la qualità dei sistemi di riscaldamento a biomasse legnose (classificazione da 1 a 5 stelle con i medesimi parametri del DM186/2017).  
Aria Pulita, the Italian voluntary quality certification for wood biomass heating systems (Classification from 1 up to 5 stars according to the parameters of the DM186/2017).  
Aria Pulita, la certification volontaire italienne pour la qualité des systèmes de chauffage à biomasses ligneuses (classification de 1 à 5 étoiles avec les mêmes paramètres du DM186/2017).  
Aria Pulita, die freiwillige italienische Zertifizierung für die Qualität von Holzbiomasse-Heizanlagen (Klassifizierung von 1 bis 5 Sternen mit den gleichen Parametern von DM186/2017).  
Aria pulita (Aire limpio), la certificación voluntaria italiana para la calidad de los sistemas de calefacción con biomasa leñosa (clasificación de 1 a 5 estrellas con los mismos parámetros del DM186/2017).



Regolamento Italiano per il rilascio del certificato ambientale per i generatori di calore alimentati a biomasse combustibili solide (classificazione da 1 a 5 stelle)  
Italian Regulation for the Environmental Certificate release of domestic solid fuels biomass room heaters (Classification from 1 up to 5 stars).  
Règlement italien concernant l'obtention du certificat environnemental pour les générateurs de chaleur alimentés par de la biomasse combustible solide (classification de 1 à 5 étoiles).  
Italienische Regelung für die Erteilung des Umweltzertifikats für Wärmezeuger, die mit fester brennbarer Biomasse betrieben werden (Klassifizierung von 1 bis 5 Sternen).  
Reglamento italiano para la concesión del certificado ambiental para los generadores de calor alimentados por biomasa combustible sólida (clasificación de 1 a 5 estrellas).



# IL FUTURO RESPIRA LE NOSTRE SCELTE

Legna e pellet, combustibili naturali, rinnovabili, potenzialmente inesauribili, rappresentano sempre di più una opportunità per non logorare ulteriormente il nostro ecosistema già provato dalle emissioni delle altre attività umane.

Durante la combustione di biomasse viene rilasciata la stessa quantità di CO<sub>2</sub> che l'albero ha assorbito durante la propria crescita, contrariamente a quanto avviene con i combustibili fossili. Carbone, petrolio e gas naturale infatti rilasciano il carbonio accumulato in milioni di anni in tempi brevi, provocando lo squilibrio ambientale conosciuto come "effetto serra".

Invece, la combustione della legna, così come gli altri processi che la scompongono, non aumenta la presenza di CO<sub>2</sub> nell'aria e quindi non crea pericolose alterazioni del clima.

Inoltre, grazie al continuo miglioramento tecnologico degli apparecchi di ultima generazione, oggi riscaldarsi con generatori moderni a biomassa significa anche ridurre le emissioni di polveri fino al 70% (fonte AIEL 2017), salvaguardando così la qualità dell'aria.

Legna e pellet sono quindi sinonimo di energia rinnovabile e contribuiscono a contrastare i cambiamenti climatici e, non meno importante, a far risparmiare sulla bolletta di casa.

Agire nel presente con lo sguardo verso il futuro: l'ambiente del nostro domani inizia oggi.



## The future breathes our choices

Wood and pellets - natural, renewable and potentially inexhaustible fuels - are becoming more and more an opportunity to stop eroding our ecosystem, which is already subjected to emissions from other human activity.

Contrary to what happens with fossil fuels, the amount of CO<sub>2</sub> emitted during biomass combustion is equal to the CO<sub>2</sub> absorbed by the tree during its growth. In fact, coal, oil and natural gas release the carbon accumulated over millions of years in a short space of time, which causes environmental imbalance, known as the "greenhouse effect".

The combustion of wood, instead, as well as the other processes that decompose it, does not increase the amount of CO<sub>2</sub> in the air and therefore does not cause dangerous climate change.

Nowadays, thanks to the continuous technological development of state of the art appliances, using modern biomass generators for heating also means that particulate emissions can be reduced by up to 70% (source: AIEL 2017), thus safeguarding air quality.

Wood and pellets are therefore synonymous with renewable energy, help fight climate change and, last but not least, can help you save on household bills.

Acting in the present with an eye on the future: the protection of tomorrow's environment starts today.

## Le futur respire nos choix

Le bois et les granulés, combustibles naturels, renouvelables et potentiellement inépuisables, représentent de plus en plus une opportunité à saisir pour ne pas porter davantage atteinte à notre écosystème déjà éprouvé par les émissions des autres activités humaines. À la différence des combustibles fossiles, la combustion de biomasse dégage la même quantité de CO<sub>2</sub> que celle que l'arbre a absorbée pendant sa croissance. En effet, le charbon, le pétrole et le gaz naturel dégagent rapidement le carbone accumulé en plusieurs millions d'années, provoquant le déséquilibre climatique dit "effet de serre". En revanche, la combustion du bois, comme ses autres processus de décomposition, n'augmente pas la quantité de CO<sub>2</sub> dans l'air et ne crée donc pas d'altérations dangereuses du climat.

En outre, grâce à l'amélioration technologique des appareils de dernière génération, aujourd'hui, le chauffage avec des générateurs à biomasse modernes permet également de réduire les émissions de particules jusqu'à 70 % (source AIEL 2017) et de préserver ainsi la qualité de l'air. Bois et granulés sont donc synonymes d'énergie renouvelable et contribuent à lutter contre les changements climatiques et, fait non négligeable, à réduire les factures domestiques. Agir aujourd'hui en pensant au futur : notre environnement de demain se crée dès à présent.

## Die Zukunft atmet unsere Entscheidungen

Holz und Pellets sind natürliche, erneuerbare und potentiell unerschöpfliche Brennstoffe und stellen immer mehr eine Möglichkeit dar, unser Ökosystem, das bereits stark durch vom Menschen verursachte Emissionen beeinträchtigt ist, nicht noch weiter zu schädigen. Bei der Verbrennung von Biomasse wird die gleiche Menge CO<sub>2</sub> freigesetzt, die der Baum während seines Wachstums aufgenommen hat, anders als bei fossilen Brennstoffen. Kohle, Erdöl und Erdgas setzen nämlich den in Millionen von Jahren angesammelten Kohlenstoff frei und verursachen damit ein Ungleichgewicht in der Umwelt, das als „Treibhauseffekt“ bekannt ist. Beim Verbrennen von Holz dagegen steigt, ebenso wie bei anderen Zersetzungsprozessen, der CO<sub>2</sub>-Gehalt der Luft nicht an und es kommt somit nicht zu gefährlichen Klimaveränderungen. Außerdem können dank der ständigen technischen Verbesserungen an den Geräten der neuesten Generation heute beim Heizen mit modernen Biomasse-Wärmeerzeugern auch die Feinstaubemissionen um bis zu 70 % gesenkt werden (Quelle: AIEL 2017). Dadurch steigt die Luftqualität. Holz und Pellets sind also ein Synonym für erneuerbare Energie und tragen dazu bei, dem Klimawandel entgegenzuwirken und gleichzeitig - was auch wichtig ist - Heizkosten einzusparen.

Mit Blick in die Zukunft heute handeln: Damit schaffen wir uns unsere zukünftige Umwelt.

## El futuro respira nuestras elecciones

La leña y el pellet, combustibles naturales, renovables y potencialmente inagotables, son cada vez más una oportunidad para no dañar más nuestro ecosistema ya contaminado por las emisiones de otras actividades humanas.

Durante la combustión de biomasa se libera la misma cantidad de CO<sub>2</sub> que el árbol ha absorbido durante su crecimiento, a diferencia de lo que ocurre con los combustibles fósiles. De hecho, el carbón, el petróleo y el gas natural liberan el carbono acumulado en millones de años en muy poco tiempo, provocando el desequilibrio medioambiental conocido como «efecto invernadero».

En cambio, la combustión de la leña, así como el resto de procesos que la descomponen, no aumenta la presencia de CO<sub>2</sub> en el aire y, por tanto, no crea alteraciones del clima peligrosas.

Además, gracias a la continua mejora tecnológica de los aparatos de última generación, en la actualidad calentarse con generadores modernos de biomasa significa también reducir las emisiones de polvos finos un 70% (fuente AIEL 2017) protegiendo así la calidad del aire.

Por tanto, la leña y el pellet son sinónimo de energía renovable y contribuyen a contrastar los cambios climáticos y a ahorrar en el recibo de casa.

Actuar en el presente mirando hacia el futuro: el medioambiente de nuestro mañana empieza hoy.

## STUFE A LEGNA

La compattezza dei materiali, l'armonia delle linee e la sicurezza nell'utilizzo sono le caratteristiche fondamentali delle stufe "La Nordica".

### WOOD STOVES:

Solid materials, harmonious lines and safe use are the fundamental characteristics of "La Nordica" stoves.

### POÊLES À BOIS:

La compacité des matériaux, l'harmonie des lignes et la sécurité d'utilisation sont les caractéristiques fondamentales des poêles "La Nordica".

### HOLZÖFEN:

Die Kompaktheit der Materialien, die Harmonie der Linien und die Sicherheit im Gebrauch sind die grundlegenden Eigenschaften der Öfen "La Nordica".

### ESTUFAS DE LEÑA:

Materiales compactos, armonía de las líneas y un uso seguro son las características esenciales de las estufas "La Nordica".



TOP DESIGN 

BIANCO INFINITY



# FLÒ

**A+** | 8,3 kW-N | 238 m<sup>3</sup>



CONTO TERMICO

Per maggiori informazioni consultare il nostro sito:

www.lanordica-extraflame.com

## PLUS

- Rivestimento esterno in maiolica
  - Cassetto cenere estraibile
  - Rivestimento interno del focolare in ghisa-Nordiker con post combustione
  - Porta e griglia in ghisa
  - Focolare a fiamma verticale
  - Ventilazione ambiente
- External facing in majolica
  - Extractable ash drawer
  - Internal facing of the hearth in cast iron and Nordiker with post combustion
  - Door and grille in cast iron
  - Vertical flame hearth
  - Room ventilation
- Revêtement extérieur en faïence
  - Tiroir cendrier amovible
  - Revêtement intérieur du foyer en fonte/Nordiker avec post combustion.
  - Porte et grille en fonte
  - Foyer à flamme verticale
  - Ventilation ambiante
  - Flamme Verte: Appareil de class 7★
- Äußere Verkleidung aus Majolika
  - Herausziehbare Aschenlade
  - Innenbekleidung des Feuerraums aus Gusseisen-Nordiker mit Doppelverbrennung
  - Tür und Rost aus Gusseisen
  - Feuerstätte mit senkrechter Flamme
  - Raumlüftung

- Revestimiento exterior de mayólica
- Cajón de cenizas extraíble
- Revestimiento interior del hogar de fundición y Nordiker con post combustión
- Puerta y rejilla de hierro fundido
- Hogar con llama vertical
- Ventilación ambiente









Simulazione uscita aria calda  
Hot air outlet simulation  
Simulation de sortie d'air chaud  
Simulation Austritt Warmluft  
Simulación de salida del aire caliente

## COLORI



Bordeaux

## DATI TECNICI

 678x1200x560	 Ghisa-Nordiker
 194	% 85,01
 326x347	 2,3
 300x400x360	Ø 150 S



## CERTIFICAZIONI

15a B-VG

BImSchV



## TECNOLOGIA

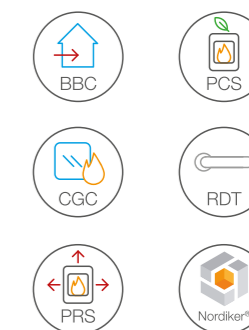

# WANDA EVO (Canalizzata)

**A+** | 8,5 kW-N | 243 m<sup>3</sup>



**CONTO TERMICO**

Per maggiori informazioni consultare il nostro sito:

[www.lanordica-extraflame.com](http://www.lanordica-extraflame.com)

## PLUS

- Stufa canalizzata con doppia uscita.
- Rivestimento esterno in maiolica.
- Focolare in ghisa con sistema di post combustione.
- Focolare a fiamma verticale.
- Telecomando di regolazione ventilazione

- Ducted stove with double outlet.
- External facing in majolica.
- Hearth in cast iron with post combustion system.
- Vertical flame hearth.
- Remote control ventilation.

- Poêle canalisé avec double sortie.
- Revêtement extérieur en faïence.
- Foyer en fonte avec système post combustion.
- Foyer à flamme verticale.
- Télécommande pour régler la ventilation.
- Flamme Verte: Appareil de class 7★

- Kanalisierter Ofen mit Doppelausgang.
- Äußere Verkleidung aus Majolika.
- Feuerraumverkleidung aus Gusseisen mit Doppelverbrennung.
- Feuerstätte mit senkrechter Flamme.
- Fernbedienung zur Gebläseeinstellung.

- Estufa canalizada con doble salida.
- Revestimiento exterior de mayólica.
- Hogar en fundición con sistema de post combustión.
- Hogar con llama vertical.
- Control remoto para regulación de ventilación.

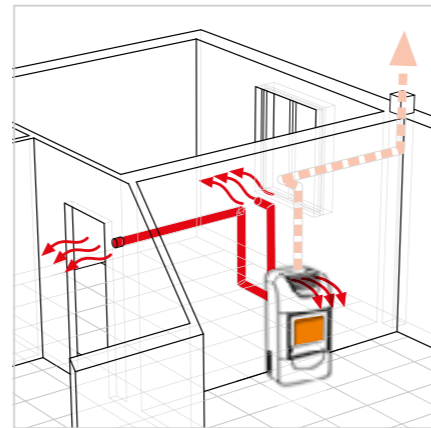

**TOP DESIGN**

BIANCO INFINITY



## DATI TECNICI

716x1338x532	Ghisa
216	85%
380x255	2,3
350x280x285	160 S



## CERTIFICAZIONI

**15a B-VG**

**BImSchV**



## TECNOLOGIA



TOP DESIGN 

BIANCO INFINITY

# WANDA CLASSIC EVO (Canalizzata)

**A+** | 8,5 kW-N | 243 m<sup>3</sup>



CONTO TERMICO

Per maggiori informazioni consultare il nostro sito:

[www.lanordica-extraflame.com](http://www.lanordica-extraflame.com)

## PLUS

- Stufa canalizzata con doppia uscita.
  - Rivestimento esterno in maiolica.
  - Focolare in ghisa con sistema di post combustione.
  - Focolare a fiamma verticale.
  - Telecomando di regolazione ventilazione.
- Ducted stove with double outlet.
  - External facing in majolica.
  - Hearth in cast iron with post combustion system.
  - Vertical flame hearth.
  - Remote control ventilation.
- Poêle canalisé avec double sortie.
  - Revêtement extérieur en faïence.
  - Foyer en fonte avec système post combustion.
  - Foyer à flamme verticale.
  - Télécommande pour régler la ventilation.
  - Flamme Verte: Appareil de class 7★
- Kanalisierter Ofen mit Doppelausgang.
  - Äußere Verkleidung aus Majolika.
  - Feuerraumverkleidung aus Gusseisen mit Doppelverbrennung.
  - Feuerstätte mit senkrechter Flamme.
  - Fernbedienung zur Gebläseinstellung.
- Estufa canalizada con doble salida.
  - Revestimiento exterior de mayólica.
  - Hogar en fundición con sistema de post combustión.
  - Hogar con llama vertical.
  - Control remoto para regulación de ventilación.

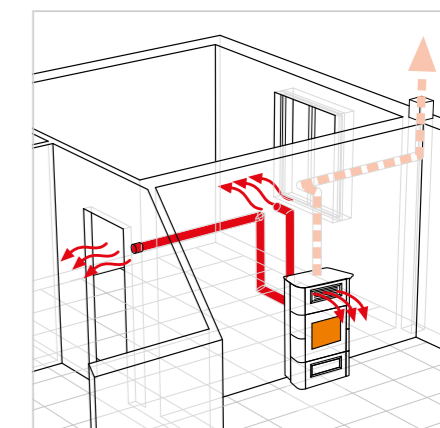







## COLORI



Bordeaux

## DATI TECNICI

 804x1270x530	 Ghisa
 228	 85,
 380x255	 2,3
 350x280x285	 160 S



## CERTIFICAZIONI

15a B-VG

BImSchV



## TECNOLOGIA



# ZEN

**A+** | 7,5 kW-N | 215 m<sup>3</sup>



## PLUS

- Porta fuoco in ghisa ad angolo.
  - Stufa angolare.
  - Rivestimento esterno in pietra naturale.
  - Rivestimento interno del focolare in ghisa-Nordiker con post combustione.
  - Focolare a fiamma verticale.
- Angular door in cast iron.
  - Angular stove.
  - External facing in natural stone.
  - Internal facing of the hearth in cast iron and Nordiker with post combustion.
  - Vertical flame hearth.
- Porte angulaire en fonte.
  - Poêle d'angle.
  - Revêtement extérieur en pierre.
  - Revêtement intérieur du foyer en fonte/ Nordiker avec post combustion.
  - Foyer à flamme verticale.
  - **Flamme Verte: Appareil de class 7★**
- Feuertür auf Eck aus Gusseisen.
  - Eckofen.
  - Äußere Verkleidung aus Naturstein.
  - Innenbekleidung des Feuerraums aus Gusseisen-Nordiker mit Doppelverbrennung.
  - Feuerstätte mit senkrechter Flamme.
- Puerta hogar en fundición angular.
  - Estufa angular.
  - Revestimiento externo en piedra natural.
  - Revestimiento interior del hogar de fundición y Nordiker con post combustión.
  - Hogar con llama vertical.

TOP DESIGN



PIETRA NATURALE

## DATI TECNICI

425x1300x460	Ghisa/Nordiker
199	% 81,6
340x370	2,1
297x490x297	Ø 130 S



## CERTIFICAZIONI

**15a B-VG**

**BImSchV**



## TECNOLOGIA



TOP DESIGN 



BORDEAUX

# HELGA EVO

**A+** | 7,3 kW-N | 209 m<sup>3</sup>



CONTO TERMICO

Per maggiori informazioni consultare il nostro sito:

[www.lanordica-extraflame.com](http://www.lanordica-extraflame.com)

## PLUS

- Rivestimento esterno in maiolica o in pietra naturale.
- Porta fuoco curva in ghisa smaltata.
- Rivestimento interno del focolare in ghisa-Nordiker con post combustione.
- Focolare a fiamma verticale.
- Basamento e testata in ghisa smaltata.
- External facing in majolica or in natural stone.
- Curved cast iron firedoor.
- Internal facing of the hearth in cast iron and Nordiker with post combustion.
- Vertical flame hearth.
- Base and top in enamelled cast iron.
- Revêtement extérieur en faïence ou en pierre.
- Porte foyer courbe et en fonte.
- Revêtement intérieur du foyer en fonte/Nordiker avec post combustion.
- Foyer à flamme verticale.
- Base et tête en fonte émaillée.
- Flamme Verte: Appareil de class 7★

- Außenverkleidung aus Majolika oder Naturstein.
- Gebeugte Feuertür aus Gusseisen.
- Innenbekleidung des Feuerraums aus Gusseisen-Nordiker mit Doppelverbrennung.
- Feuerstätte mit senkrechter Flamme.
- Sockel und Kopf aus emailliertem Gusseisen.
- Revestimiento externo de mayólica o piedra natural.
- Puerta hogar curva de fundición.
- Revestimiento interior del hogar de fundición y Nordiker con post combustión.
- Hogar con llama vertical.
- Base y cabecera de fundición esmaltada.

## COLORI









Pietra Naturale



Titanio

## DATI TECNICI

 524x1122x509	 Ghisa-Nordiker
 165 mod. BO-TI 183 mod. PT	% 86,8
 327x360	 2
 318x415x370	∅ 130 S



## CERTIFICAZIONI

15a B-VG

BImSchV



## TECNOLOGIA

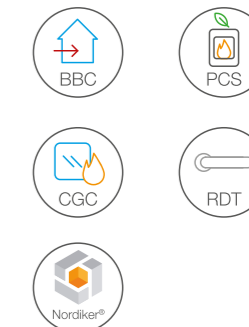



Ghisa smaltata

# GIULIETTA X 4.0









**A+** | 6,5 kW-N | 186 m<sup>3</sup>



## PLUS

- Stufa interamente in ghisa smaltata.
  - Porta di carica frontale.
  - Ghisa ad alto rendimento termico.
  - Focolare in ghisa con sistema di post combustione.
  - Vetro ceramico resistente fino a 750° C.
- Stove made completely of Enamelled cast-iron.
  - Front loading door.
  - Very high thermic yield cast-iron.
  - Hearth in cast iron with post combustion system.
  - Ceramic glass resistant up to 750° C.
- Poêle entièrement en fonte émaillée.
  - Porte de chargement frontal.
  - Fonte à rendement thermique élevé.
  - Foyer en fonte avec système post combustion.
  - Vitre céramique résistante à 750° C.
  - Flamme Verte: Appareil de class 7★
- Ofen vollständig aus emailliertem Gusseisen.
  - Tür Frontbeschickung.
  - Gusseisen mit hoher Wärmeleistung.
  - Feuerraumverkleidung aus Gusseisen mit Doppelverbrennung.
  - Keramikglas bis 750° C wärmebeständig.
- Estufa completamente de fundición esmaltada.
  - Puerta de carga frontal.
  - Fundición de alto rendimiento térmico.
  - Hogar de fundición con sistema de post combustión.
  - Cristal cerámico resistente hasta 750° C.

## DATI TECNICI

 487x706x430	 Ghisa
 115	 81,7
 235x260	 1,9
 350x290x225	 120 S/P



## CERTIFICAZIONI

**15a B-VG**

**BImSchV**



## TECNOLOGIA





# ISETTA CON CERCHI EVO 4.0

**A+** | 7,3 kW-N | 209 m<sup>3</sup>



## PLUS

- Stufa interamente in ghisa smaltata.
- Porta di carica frontale e laterale.
- Ghisa ad alto rendimento termico.
- Piastra in ghisa levigata.
- Focolare in ghisa con sistema di post combustione.
- Vetro ceramico resistente fino a 750° C.

- Stove made completely of Enamelled cast-iron.
- Front and side loading door .
- Very high thermic yield cast-iron.
- Smooth cast iron plate.
- Hearth in cast iron with post combustion system.
- Ceramic glass resistant up to 750° C.

- Poêle entièrement en fonte émaillée.
- Porte de chargement frontal et latéral.
- Fonte à rendement thermique élevé.
- Plaque en fonte polie.
- Foyer en fonte avec système post combustion.
- Vitre céramique résistante à 750° C.
- Flamme Verte: Appareil de class 7★

- Ofen vollständig aus emailliertem Gusseisen.
- Tür Front- und Seitenbeschickung.
- Gusseisen mit hoher Wärmeleistung.
- Geschliffene Gusseisenplatte.
- Feuerraumverkleidung aus Gusseisen mit Doppelverbrennung.
- Keramikglas bis 750° C wärmebeständig.

- Estufa completamente de fundición esmaltada.
- Puerta de carga frontal y lateral.
- Fundición de alto rendimiento térmico.
- Plancha de fundición pulida.
- Hogar en fundición con sistema de post combustión.
- Cristal cerámico resistente hasta 750° C.

Ghisa smaltata

GHISA

## DATI TECNICI

660x760x590	Ghisa
167	83,6
380x225	2
439x280x200	150 S/P



## CERTIFICAZIONI

15a B-VG

BImSchV



## TECNOLOGIA



# ISETTA EVO 4.0

**A+** | 7,3 kW-N | 209 m<sup>3</sup>

## PLUS

- Stufa interamente in ghisa smaltata.
- Porta di carica frontale e laterale.
- Ghisa ad alto rendimento termico
- Focolare in ghisa con sistema di post combustione.
- Vetro ceramico resistente fino a 750° C.

- Stove made completely of Enamelled cast-iron.
- Front and side loading door .
- Very high thermic yield cast-iron
- Hearth in cast iron with post combustion system.
- Ceramic glass resistant up to 750° C.

- Poêle entièrement en fonte émaillée.
- Porte de chargement frontal et latéral.
- Fonte à rendement thermique élevé.
- Foyer en fonte avec système post combustion.
- Vitre céramique résistante à 750° C.
- **Flamme Verte: Appareil de class 7★**





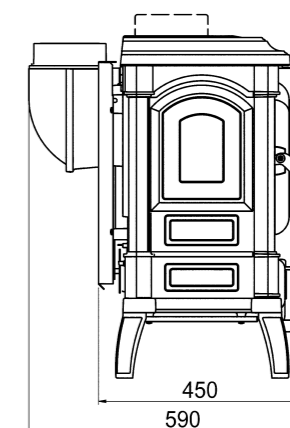



- Ofen vollständig aus emailliertem Gusseisen.
- Tür Front- und Seitenbeschickung.
- Gusseisen mit hoher Wärmeleistung.
- Feuerraumverkleidung aus Gusseisen mit Doppelverbrennung.
- Keramikglas bis 750° C wärmebeständig.

- Estufa completamente de fundición esmaltada.
- Puerta de carga frontal y lateral.
- Fundición de alto rendimiento térmico.
- Hogar en fundición con sistema de post combustión.
- Cristal cerámico resistente hasta 750° C.



Ghisa smaltata

## DATI TECNICI

 660x706x590	 Ghisa
 160	 83,6
 380x225	 2
 439x280x200	 150 S/P



## CERTIFICAZIONI

**15a B-VG**

**BImSchV**



## TECNOLOGIA



# ISOTTA CON CERCHI EVO

**A+** | 11,9 kW-N | 338 m<sup>3</sup>



## PLUS

- Stufa interamente in ghisa smaltata.
- Porta di carica frontale e laterale.
- Ghisa ad alto rendimento termico.
- Piastra in ghisa levigata.
- Focolare in ghisa con sistema di post combustione.
- Vetro ceramico resistente fino a 750° C.

- Stove made completely of Enamelled cast-iron.
- Front and side loading door.
- Very high thermic yield cast-iron.
- Smooth cast iron plate.
- Hearth in cast iron with post combustion system.
- Ceramic glass resistant up to 750° C.

- Poêle entièrement en fonte émaillée.
- Porte de chargement frontal et latéral.
- Fonte à rendement thermique élevé.
- Plaque en fonte polie.
- Foyer en fonte avec système post combustion.
- Vitre céramique résistante à 750° C.
- Flamme Verte: Appareil de class 7★

- Ofen vollständig aus emailliertem Gusseisen.
- Tür Front- und Seitenbeschickung.
- Gusseisen mit hoher Wärmeleistung.
- Geschliffene Gusseisenplatte.
- Feuerraumverkleidung aus Gusseisen mit Doppelverbrennung.
- Keramikglas bis 750° C wärmebeständig.

- Estufa completamente de fundición esmaltada.
- Puerta de carga frontal y lateral.
- Fundición de alto rendimiento térmico.
- Plancha de fundición pulida.
- Hogar en fundición con sistema de post combustión.
- Cristal cerámico resistente hasta 750° C.



## DATI TECNICI

790x830x660	Ghisa
216	82
519x305	3,2
597x360x290	150 S/P



## CERTIFICAZIONI

15a B-VG

BImSchV



## TECNOLOGIA

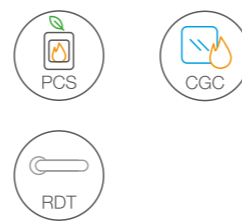

Ghisa smaltata



# ISOTTA EVO

**A+** | 11,9 kW-N | 338 m<sup>3</sup>

## PLUS

- Stufa interamente in ghisa smaltata.
- Porta di carica frontale e laterale.
- Ghisa ad alto rendimento termico.
- Focolare in ghisa con sistema di post combustione.
- Vetro ceramico resistente fino a 750° C.

- Stove made completely of Enamelled cast-iron.
- Front and side loading door .
- Very high thermic yield cast-iron.
- Hearth in cast iron with post combustion system.
- Ceramic glass resistant up to 750° C.







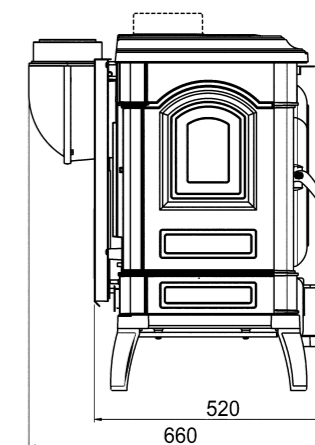

- Poêle entièrement en fonte émaillée.
- Porte de chargement frontal et latéral.
- Fonte à rendement thermique élevé.
- Foyer en fonte avec système post combustion.
- Vitre céramique résistante à 750° C.
- **Flamme Verte: Appareil de class 7★**

- Ofen vollständig aus emailliertem Gusseisen.
- Tür Front- und Seitenbeschickung.
- Gusseisen mit hoher Wärmeleistung.
- Feuerraumverkleidung aus Gusseisen mit Doppelverbrennung.
- Keramikglas bis 750° C wärmebeständig.

- Estufa completamente de fundición esmaltada.
- Puerta de carga frontal y lateral.
- Fundición de alto rendimiento térmico.
- Hogar en fundición con sistema de post combustión.
- Cristal cerámico resistente hasta 750° C.



## DATI TECNICI

 790x775x660	 Ghisa
 205	 82
 519x305	 3,2
 597x360x290	 150 S/P



## CERTIFICAZIONI

**15a B-VG**
**BImSchV**



## TECNOLOGIA



# ISOTTA FORNO EVO

**A+** | 9,7 kW-N | 278 m<sup>3</sup>



CONTO TERMICO

Per maggiori informazioni consultare il nostro sito:

[www.lanordica-extraflame.com](http://www.lanordica-extraflame.com)

## PLUS

- Stufa interamente in ghisa smaltata.
  - Porta di carica frontale e laterale.
  - Ghisa ad alto rendimento termico.
  - Forno smaltato panoramico da 39 l con interno in pietra lavica.
  - Focolare in ghisa con sistema di post combustione.
  - Vetro ceramico resistente fino a 750° C.
  - Griglia forno cromata di serie.
- Stove made completely of Enamelled cast-iron.
  - Front and side loading door.
  - Very high thermic yield cast-iron
  - 39l panoramic enamelled oven with lava stone interior.
  - Hearth in cast iron with post combustion system.
  - Ceramic glass resistant up to 750° C.
  - Chromed oven rack.
- Poêle entièrement en fonte émaillée.
  - Porte de chargement frontal et latéral.
  - Fonte à rendement thermique élevé.
  - Four émaillé panoramique de 39 l avec intérieur en pierre lavique .
  - Foyer en fonte avec système post combustion.
  - Vitre céramique résistante à 750° C.
  - Équipé avec une grille chromée pour le four.
  - **Flamme Verte: Appareil de class 7★**
- Ofen vollständig aus emailliertem Gusseisen.
  - Tür Front- und Seitenbeschickung.
  - Gusseisen mit hoher Wärmeleistung.
  - Panoramaofen emailliert 39 l mit Innenbereich aus Lavastein.
  - Feuerraumverkleidung aus Gusseisen mit Doppelverbrennung.
  - Keramikglas bis 750° C wärmebeständig.
  - Ausgestattet mit Backofenrost.
- Estufa completamente de fundición esmaltada.
  - Puerta de carga frontal y lateral.
  - Fundición de alto rendimiento térmico.
  - Horno esmaltado panorámico de 39 l con interior de piedra volcánica.
  - Hogar en fundición con sistema de post combustión.
  - Cristal cerámico resistente hasta 750° C.
  - Equipada con rejilla de horno cromada.

Ghisa smaltata

GHISA



## DATI TECNICI

795x1244x530	Ghisa
300	87,7
519x305	2,6
546x360x290	150 S
443x290x305	



## CERTIFICAZIONI

15a B-VG

BImSchV



## TECNOLOGIA



# JENNIFER

**A+** | 7,5 kW-N | 215 m<sup>3</sup>



## PLUS

- Stufa interamente in ghisa smaltata ad alto rendimento termico
  - Possibilità di caricare ceppi da 50 cm
  - Focolare in ghisa e Nordiker con sistema di post-combustione
  - Cassetto cenere estraibile frontalmente
  - Possibilità di prelevare l'aria comburente dall'esterno
- Entirely cast iron enameled Stove
  - Logs up to 50 cm
  - Firebox made of cast iron and Nordiker with post-combustion system
  - Front extractable ash drawer
  - External air intake
- Foyer en fonte émaillé
  - Accepte des bûches de 50 cm
  - Foyer en Fonte (Très solide) et en Nordiker avec système de post-combustion
  - Tiroir à cendres à extraire en façade
  - Raccordable à l'air extérieur
  - Flamme Verte: Appareil de class 7★
- Ofen komplett aus emailliertem Gusseisen mit hoher thermischer Effizienz
  - Möglichkeit 50cm Holzscheite nachzuladen
  - Feuerraum aus Gusseisen und aus Nordiker- Schamott mit Nachverbrennungssystem
  - Frontal ausziehbarer Aschekasten
  - Möglichkeit die Verbrennungsluft direkt von außen anzusaugen
- Estufa completamente de hierro fundido esmaltado de alto rendimiento térmico
  - Posibilidad de carga de leña de 50cm
  - Hogar de hierro fundido y Nordiker con sistema de post-combustión
  - Cajón de la ceniza extraíble frontalmente
  - Posibilidad de tomar el aire de la combustión del exterior



Ghisa smaltata

## DATI TECNICI

702x870x426	Ghisa-Nordiker
141	81,5
532x212	2,2
630x320x255	150 S



## CERTIFICAZIONI

15a B-VG

BImSchV



## TECNOLOGIA

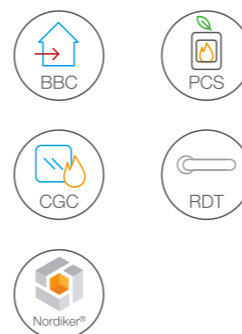

# JENNIFER PRS

**A+** | 8,0 kW-N | 229 m<sup>3</sup>



**CONTO TERMICO**

Per maggiori informazioni consultare il nostro sito:

[www.lanordica-extraflame.com](http://www.lanordica-extraflame.com)

GHISA

## PLUS

- Sistema Power Radiant System
- Stufa interamente in ghisa smaltata ad alto rendimento termico
- Possibilità di caricare ceppi da 50 cm
- Focolare in ghisa e Nordiker con sistema di post-combustione
- Cassetto cenere estraibile frontalmente
- Possibilità di prelevare l'aria comburente dall'esterno

- Power Radiant System (PRS)
- Entirely cast iron enameled Stove
- Logs up to 50 cm
- Firebox made of cast iron and Nordiker with post-combustion system
- Front extractable ash drawer
- External air intake

- Système Radiant
- Foyer en fonte émaillé
- Accepte des bûches de 50 cm
- Foyer en Fonte (Très solide) et en Nordiker avec système de post-combustion
- Tiroir à cendres à extraire en façade
- Raccordable à l'air extérieur
- Flamme Verte: Appareil de class 7★

- Power Radiant System
- Ofen komplett aus emailliertem Gusseisen mit hoher thermischer Effizienz
- Möglichkeit 50cm Holzscheite nachzuladen
- Feuerraum aus Gusseisen und aus Nordiker- Schamott mit Nachverbrennungssystem
- Frontal ausziehbarer Aschekasten
- Möglichkeit die Verbrennungsluft direkt von außen anzuzugeln

- Sistema Power Radiant System
- Estufa completamente de hierro fundido esmaltado de alto rendimiento térmico
- Posibilidad de carga de leña de 50cm
- Hogar de hierro fundido y Nordiker con sistema de post combustión
- Cajón de la ceniza extraíble frontalmente
- Posibilidad de tomar el aire de la combustión del exterior



## DATI TECNICI

702x1446x550	Ghisa-Nordiker
188	% 87,3
532x212	2
630x320x255	150 S



## CERTIFICAZIONI

**15a B-VG**

**BImSchV**



## TECNOLOGIA

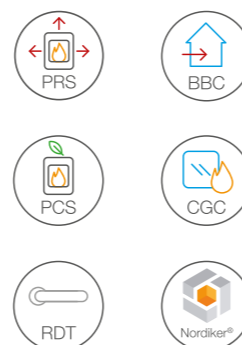

# MARLENA

**A+** | 7,5 kW-N | 215 m<sup>3</sup>



**CONTO TERMICO**

Per maggiori informazioni consultare il nostro sito:

[www.lanordica-extraflame.com](http://www.lanordica-extraflame.com)



## PLUS

- Stufa interamente in ghisa smaltata
- Porta fuoco curva in ghisa
- Focolare in ghisa e Nordiker
- Cassetto cenere estraibile frontalmente
- Aria primaria e secondaria regolabile con unico registro, aria terziaria prearata con sistema di post combustione
- Maniglia ergonomica
- Vetro ceramico resistente fino a 750° C
- Possibilità di prelevare l'aria dall'esterno

- Stove made completely of Enamelled cast-iron.
- Curved cast iron firedoor.
- Firebox made of cast iron and Nordiker
- Extractable ash drawer
- Adjustable primary and secondary air, preset tertiary air with post combustion system
- Ergonomic handle
- Ceramic glass resistant up to 750° C
- External air intake

- Poêle entièrement en fonte émaillée
- Porte foyer courbe et en fonte
- Foyer en Fonte (Très solide) et en Nordiker
- Tiroir à cendres à extraire
- Air primaire et secondaire réglables, air tertiaire pré-calibré avec système post combustion
- Poignée ergonomique
- Vitre céramique résistante à 750° C
- Raccordable à l'air extérieur
- Flamme Verte: Appareil de class 7★

- Ofen vollständig aus emailliertem Gusseisen
- Gebeugte Feuertür aus Gusseisen
- Feuerraum aus Gusseisen und aus Nordiker- Schamott
- ausziehbarer Aschekasten
- Verstellbare primär und Sekundärluft, voraustarierte Tertiärluft mit Nachverbrennungssystem
- Ergonomischer Handgriff
- Keramikglas bis 750° C wärmebeständig

- Estufa completamente de fundición esmaltada.
- Puerta curva de fundición.
- Hogar de hierro fundido y Nordiker.
- Cajón de la ceniza extraíble.
- Aire primario y secundario regulable, aire terciario con sistema de postcombustión precalibrado.
- Manija ergonómica.
- Cristal cerámico resistente hasta 750° C.

## OPTIONAL

Schermo di calore posteriore  
Rear heat shield  
Plaque de protection chaleur postérieure  
Hitzeschutzschirm  
Pantalla de protección contra el calor



## DATI TECNICI

465x1060x475	Ghisa-Nordiker
140	86,5
270x375	2
295x420x310	130 S



## CERTIFICAZIONI

**15a B-VG**

**BImSchV**



## TECNOLOGIA

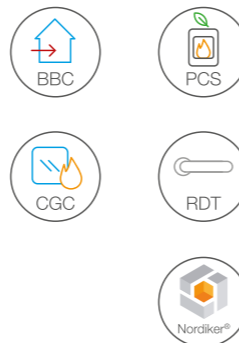

Ghisa smaltata



# CANDY 4.0

**A+** | 6,2 kW-N | 177 m<sup>3</sup>

## PLUS

- Stufa interamente in ghisa smaltata.
  - Ghisa ad alto rendimento termico.
  - Focolare in ghisa con sistema di post combustione.
  - Vetro ceramico resistente fino a 750° C.
- Stove made completely of Enamelled cast-iron.
  - Very high thermic yield cast-iron.
  - Hearth in cast iron with post combustion system.
  - Ceramic glass resistant up to 750° C.
- Poêle entièrement en fonte émaillée.
  - Fonte à rendement thermique élevé.
  - Foyer en fonte avec système post combustion.
  - Vitre céramique résistante à 750° C.
  - **Flamme Verte: Appareil de class 7★**
- Ofen vollständig aus emailliertem Gusseisen.
  - Gusseisen mit hoher Wärmeleistung.
  - Feuerraumverkleidung aus Gusseisen mit Doppelverbrennung.
  - Keramikglas bis 750° C wärmebeständig.
- Estufa completamente de fundición esmaltada.
  - Fundición de alto rendimiento térmico.
  - Hogar en fundición con sistema de post combustión.
  - Cristal cerámico resistente hasta 750° C.



### CONTO TERMICO

Per maggiori informazioni consultare il nostro sito:

[www.lanordica-extraflame.com](http://www.lanordica-extraflame.com)



Ghisa smaltata



## DATI TECNICI

404x890x397	Ghisa
85	% 85,1
233x315	1,7
330x356x215	Ø 120 S



## CERTIFICAZIONI

15a B-VG

BImSchV



## TECNOLOGIA



# BRIGITTA GB

**A+** | 4,7 kW-N | 134 m<sup>3</sup>

## PLUS

- Stufa interamente in ghisa smaltata.
- Ghisa ad alto rendimento termico.
- Focolare in ghisa con sistema di post combustione.
- Vetro ceramico resistente fino a 750° C.

- Stove made completely of Enamelled cast-iron.
- Very high thermic yield cast-iron.
- Hearth in cast iron with post combustion system.
- Ceramic glass resistant up to 750° C.

- Poêle entièrement en fonte émaillée.
- Fonte à rendement thermique élevé.
- Foyer en fonte avec système post combustion.
- Vitre céramique résistante à 750° C.
- **Flamme Verte: Appareil de class 7★**

Ofen vollständig aus emailliertem Gusseisen.  
 Gusseisen mit hoher Wärmeleistung.  
 Feuerraumverkleidung aus Gusseisen mit Doppelverbrennung.  
 Keramikglas bis 750° C wärmebeständig.







- Estufa completamente de fundición esmaltada.
- Fundición de alto rendimiento térmico.
- Hogar en fundición con sistema de post combustión.
- Cristal cerámico resistente hasta 750° C.



Ghisa smaltata



## DATI TECNICI

 404x640x397	 Ghisa
 70	 81
 233x214	 1,4
 330x294x215	 120 S



## CERTIFICAZIONI

**15a B-VG**

**BImSchV**

**flamme VERTE**

**HETAS**

## TECNOLOGIA



PERGAMENA

# STEFANY FORNO BII

**A+** | 10,6 kW-N | 303 m<sup>3</sup>**CONTO TERMICO**

Per maggiori informazioni consultare il nostro sito:

[www.lanordica-extraflame.com](http://www.lanordica-extraflame.com)**PLUS**

- Focolare in ghisa con sistema di post combustione.
  - Vano porta legna.
  - Rivestimento esterno in maiolica o pietra naturale.
  - Focolare a fiamma verticale.
  - Forno smaltato estraibile da 24 l.
  - Vetro ceramico resistente fino a 750° C.
- Feuerraumverkleidung aus Gusseisen mit Doppelverbrennung.
  - Holzlagerfach.
  - Außenverkleidung aus Majolika oder Naturstein.
  - Feuerstätte mit senkrechter Flamme.
  - Herausziehbarer-und emailierter Backfach mit 24 l Inhalt.
  - Keramikglas bis 750° C wärmebeständig.
- Hearth in cast iron with post combustion system.
  - Wood compartment.
  - External facing in majolica or in natural stone.
  - Vertical flame hearth.
  - Extractable Enamelled oven 24 l.
  - Ceramic glass resistant up to 750° C.
- Foyer en fonte avec système post combustion.
  - Compartiment de rangement bois.
  - Revêtement extérieur en faïence ou en pierre.
  - Foyer à flamme verticale.
  - Four émaillé amovible de 24 l.
  - Vitre céramique résistante à 750° C.
  - Flamme Verte: Appareil de class 7★
- Hogar en fundición con sistema de post combustión.
  - Compartimento para la leña.
  - Revestimiento externo de mayólica o piedra natural.
  - Hogar con llama vertical.
  - Horno esmaltado extraíble de 24 l.
  - Cristal cerámico resistente hasta 750° C.









**COLORI**

Bordeaux



Pietra Naturale

**DATI TECNICI**

	660x1300x586		Ghisa
	239 mod. BO-PE 371 mod. PT		85,1
	300x340		2,9
	377x340x388		150 S/P
	417x210x275		

**CERTIFICAZIONI****15a B-VG****BImSchV****TECNOLOGIA**

# SVEZIA NEW BII NORVEGIA NEW BII



CONTO TERMICO

Per maggiori informazioni consultare il nostro sito:

www.lanordica-extraflame.com

**A+** | 10,6 kW-N | 303 m<sup>3</sup>

## PLUS

- Focolare in ghisa con sistema di post combustione.
- Rivestimento esterno in acciaio e maiolica o pietra naturale.
- Cupola in acciaio smaltato.
- Vano porta legna.
- Porte in ghisa.
- Focolare a fiamma verticale.
- Vano scaldavivande.
- Vetro ceramico resistente fino a 750° C.

- Hearth in cast iron with post combustion system.
- External facing in steel and majolica or natural stone.
- Enamelled steel dome.
- Wood compartment.
- Cast iron doors.
- Vertical flame hearth.
- Food warmer compartment.
- Ceramic glass resistant up to 750° C.

- Foyer en fonte avec système post combustion.
- Revêtement extérieur en acier, en faïence ou en pierre.
- Coupole en acier émaillé.
- Compartiment de rangement bois.
- Portes en fonte.
- Foyer à flamme verticale.
- Compartiment pour réchauffer les aliments.
- Vitre céramique résistante à 750° C.
- Flamme Verte: Appareil de class 7★

- Feuerraumverkleidung aus Gusseisen mit Doppelverbrennung.
- Außenverkleidung aus Stahl und Majolika oder Naturstein.
- Kuppel aus emailliertem Stahl.
- Holzlagerfach.
- Tür aus Gusseisen.
- Feuerstätte mit senkrechter Flamme.
- Fach zum Warmhalten von Lebensmitteln.
- Keramikglas bis 750° C wärmebeständig.

- Hogar en fundición con sistema de post combustión.
- Revestimiento externo de acero y mayólica o piedra natural.
- Cúpula de acero esmaltado.
- Compartimento para la leña.
- Puerta de fundición.
- Hogar con llama vertical.
- Compartimento calentaplatos.
- Cristal cerámico resistente hasta 750° C.

## COLORI



Norvegia New BII



Svezia New BII Bordeaux

## DATI TECNICI

	Svezia 607x1254x554 Norvegia 599x1254x554		Ghisa
	Svezia BO 191 Svezia PT 203 Norvegia NE 188	%	85,1
	300x340		2,9
	377x340x388		150 S/P



## CERTIFICAZIONI

15a B-VG

BlmSchV



## TECNOLOGIA



ARMONY

SVEZIA NEW BII PIETRA NATURALE



# EMILIANA

**A+** | 6,5 kW-N | 186 m<sup>3</sup>



**CONTO TERMICO**

Per maggiori informazioni consultare il nostro sito:

[www.lanordica-extraflame.com](http://www.lanordica-extraflame.com)

## PLUS

- Focolare in ghisa
- Rivestimento esterno in maiolica
- Porte e telaio in ghisa smaltata
- Basamento e testata in ghisa smaltata
- Aria primaria e secondaria regolabile, terziaria pretarata con sistema di post-combustione
- Vetro ceramico resistente a 750° C
- Hearth in cast iron
- External facing in majolica
- Enameled cast iron top, door and base
- Adjustable primary and secondary air, preset tertiary air with post combustion system
- Ceramic glass resistant up to 750° C
- Foyer en fonte
- Revêtement extérieur en faïence
- Porte, élément supérieur et bâti en fonte émaillée
- Air primaire et secondaire réglables, air tertiaire pré-calibré avec système post combustion
- Vitre céramique résistante à 750° C
- Flamme Verte: Appareil de class 7★

- Feuerraumverkleidung aus Gusseisen
- Äußere Verkleidung aus Majolika.
- Tür, Kopf und Sockel aus emailliertem Gusseisen.
- Verstellbare primär und Sekundärluft, voraustarierte Tertiärluft mit Nachverbrennungssystem.
- Keramikglas bis 750° C wärmebeständig.
- Hogar de fundición.
- Revestimiento exterior de mayólica.
- Puerta, cabecera y base de fundición esmaltada.
- Aire primario y secundario regulable, aire terciario con sistema de postcombustión precalibrado.
- Cristal cerámico resistente hasta 750° C.

## COLORI



Blanco Infinity

## DATI TECNICI

453x950x490	Ghisa
140	88,7
210x255	1,7
273x330x320	120 S



## CERTIFICAZIONI

**15a B-VG**

**BImSchV**



## TECNOLOGIA



ARMONY



BORDEAUX

# FEDORA

**A+** | 8,3 kW-N | 238 m<sup>3</sup>



**CONTO TERMICO**

Per maggiori informazioni consultare il nostro sito:

[www.lanordica-extraflame.com](http://www.lanordica-extraflame.com)

## PLUS

- Rivestimento esterno in maiolica.
  - Focolare in ghisa con sistema di post combustione.
  - Porta, testata e basamento in ghisa smaltata.
  - Vetro ceramico resistente fino a 750° C.
- External facing in majolica.
  - Hearth in cast iron with post combustion system.
  - Enameled cast iron top, door and base.
  - Ceramic glass resistant up to 750° C.
- Revêtement extérieur en faïence.
  - Foyer en fonte avec système post combustion.
  - Porte, élément supérieur et bâti en fonte émaillée.
  - Vitre céramique résistante à 750° C.
  - **Flamme Verte: Appareil de class 7★**
- Äußere Verkleidung aus Majolika.
  - Feuerraumverkleidung aus Gusseisen mit Doppelverbrennung.
  - Tür, Kopf und Sockel aus emailliertem Gusseisen.
  - Keramikglas bis 750° C wärmebeständig.
- Revestimiento exterior de mayólica.
  - Hogar en fundición con sistema de post combustión.
  - Puerta, cabecera y base de fundición esmaltada.
  - Cristal cerámico resistente hasta 750° C.

## COLORI



Bordeaux

## DATI TECNICI

559x1035x547	Ghisa
175	% 86,4
315x285	2,25
377x368x362	Ø 130 S



## CERTIFICAZIONI

**15a B-VG**

**BImSchV**



## TECNOLOGIA



ARMONY



BIANCO INFINITY

# NICOLETTA

**A+** | 8,0 kW-N | 229 m<sup>3</sup>



## PLUS

- Focolare in ghisa con sistema di post combustione.
- Rivestimento esterno in maiolica decorata a mano.
- Porta in ghisa smaltata.
- Cassetto porta legna estraibile.
- Vetro ceramico resistente fino a 750° C.

- Hearth in cast iron with post combustion system.
- Hand Enamelled, majolica facing.
- Enamelled cast iron door.
- Extractable wood drawer.
- Ceramic glass resistant up to 750° C.

- Foyer en fonte avec système post combustion.
- Revêtement en maiolique décoré à main.
- Porte en fonte émaillée.
- Tiroir à bois amovible.
- Vitre céramique résistante à 750° C.
- Flamme Verte: Appareil de class 7★

- Feuerraumverkleidung aus Gusseisen mit Doppelverbrennung.
- Verkleidung aus Majolika mit handwerklichen Dekor.
- Tür aus emailliertem Gusseisen.
- Herausziehbare Holzschublade.
- Keramikglas bis 750° C wärmebeständig.

- Hogar en fundición con sistema de post combustión.
- Revestimiento de mayólica, decoración a mano.
- Puerta de fundición esmaltada.
- Cajón extraíble para la leña.
- Cristal cerámico resistente hasta 750° C.

## COLORI



Pergamena



Bordeaux

## DATI TECNICI

↓ 587x980x572

▣ Ghisa

kg 168

% 80,9

▣ 355x245

🕒 2,3

▣ 374x360x350

∅ 130 S



## CERTIFICAZIONI

15a B-VG

BImSchV



## TECNOLOGIA



SILK VOGUE AMETISTA

ARMONY



# NICOLETTA FORNO EVO

**A+** | 9,1 kW-N | 260 m<sup>3</sup>



**CONTO TERMICO**

Per maggiori informazioni consultare il nostro sito:

[www.lanordica-extraflame.com](http://www.lanordica-extraflame.com)

## PLUS

- Focolare in ghisa con sistema di post combustione.
- Rivestimento esterno in maiolica decorata a mano.
- Porta in ghisa smaltata.
- Capacità forno 37 l.
- Cassetto porta legna estraibile.
- Vetro ceramico resistente fino a 750° C.

- Hearth in cast iron with post combustion system.
- Hand Enamelled, majolica facing.
- Enamelled cast iron door.
- Oven capacity 37 l.
- Extractable wood drawer.
- Ceramic glass resistant up to 750° C.

- Foyer en fonte avec système post combustion.
- Revêtement en maiolique décoré à main.
- Porte en fonte émaillée.
- Capacité du four 37 l.
- Tiroir à bois amovible.
- Vitre céramique résistante à 750° C.
- Flamme Verte: Appareil de class 7★

- Feuerraumverkleidung aus Gusseisen mit Doppelverbrennung.
- Verkleidung aus Majolika mit handwerklichen Dekor.
- Tür aus emailliertem Gusseisen.
- Ofeninhalt 37 l.
- Herausziehbare Holzschublade.
- Keramikglas bis 750° C wärmebeständig.

- Hogar en fundición con sistema de post combustión.
- Revestimiento de mayólica, decoración a mano.
- Puerta de fundición esmaltada
- Capacidad del horno 37 l.
- Cajón extraíble para la leña.
- Cristal cerámico resistente hasta 750° C.

## COLORI



Silk Vogue Ametista

## DATI TECNICI

587x1423x572	Ghisa
242	% 86
355x245	2,4
379x370x327	Ø 130 S
330x300x370	



## CERTIFICAZIONI

**15a B-VG**

**BImSchV**



## TECNOLOGIA



ARMONY





# GAIA

**A+** | 6,0 kW-N | 172 m<sup>3</sup>



## PLUS

- Focolare in ghisa con sistema di post combustione.
- Rivestimento esterno in maiolica.
- Porta in ghisa smaltata.
- Vetro ceramico resistente fino a 750° C.
- Hearth in cast iron with post combustion system.
- External facing in majolica.
- Enamelled cast iron door.
- Ceramic glass resistant up to 750° C.
- Foyer en fonte avec système post combustion.
- Revêtement extérieur en faïence.
- Porte en fonte émaillée.
- Vitre céramique résistante à 750° C.
- **Flamme Verte: Appareil de class 7★**
- Feuerraumverkleidung aus Gusseisen mit Doppelverbrennung.
- Äußere Verkleidung aus Majolika.
- Tür aus emailliertem Gusseisen.
- Keramikglas bis 750° C wärmebeständig.
- Hogar en fundición con sistema de post combustión.
- Revestimiento exterior de mayólica.
- Puerta de fundición esmaltada.
- Cristal cerámico resistente hasta 750° C.

## COLORI



Pergamena

## DATI TECNICI

495x906x468	Ghisa
133	% 82
210x255	1,7
273x370x300	Ø 120 S



## CERTIFICAZIONI

**15a B-VG**

**BImSchV**



## TECNOLOGIA



BORDEAUX



ARMONY



PERGAMENA



# GAIA FORNO

**A+** | 6,0 kW-N | 172 m<sup>3</sup>

## PLUS

- Focolare in ghisa con sistema di post combustione.
- Rivestimento esterno in maiolica.
- Porta in ghisa smaltata.
- Forno smaltato da 19 l.
- Vetro ceramico resistente fino a 750° C.
- Feuerraumverkleidung aus Gusseisen mit Doppelverbrennung.
- Äußere Verkleidung aus Majolika.
- Tür aus emailliertem Gusseisen.
- Emaillierter Ofen mit 19 l Inhalt.
- Keramikglas bis 750° C wärmebeständig.
- Hearth in cast iron with post combustion system.
- External facing in majolica.
- Enamelled cast iron door.
- Enamelled oven of 19 l.
- Ceramic glass resistant up to 750° C.
- Foyer en fonte avec système post combustion.
- Revêtement extérieur en faïence.
- Porte en fonte émaillée.
- Four émaillé de 19 l.
- Vitre céramique résistante à 750° C.
- Flamme Verte: Appareil de class 7★
- Hogar en fundición con sistema de post combustión.
- Revestimiento exterior de mayólica.
- Puerta de fundición esmaltada.
- Horno esmaltado de 19 l.
- Cristal cerámico resistente hasta 750° C.











## COLORI



Bordeaux

## DATI TECNICI

 495x1331x468	 Ghisa
 186	 82
 210x255	 1,7
 273x370x300	 120 S
 227x296x290	



## CERTIFICAZIONI

**15a B-VG**

**BImSchV**



## TECNOLOGIA



BORDEAUX

# GISELLA







**A** | 8,0 kW-N | 229 m<sup>3</sup>**PLUS**

- Focolare in ghisa con sistema di post combustione.
- Rivestimento esterno in maiolica e acciaio.
- Porta in ghisa.
- Piastra in ghisa levigata.
- Vano porta legna.
- Vetro ceramico resistente fino a 750° C.
- Feuerraumverkleidung aus Gusseisen mit Doppelverbrennung.
- Außenverkleidung aus Majolika und Stahl.
- Tür aus Gusseisen.
- Geschliffene Gusseisenplatte.
- Holzlagerfach.
- Keramikglas bis 750° C wärmebeständig.
- Hearth in cast iron with post combustion system.
- External facing in majolica and steel.
- Door in cast iron.
- Smooth cast iron plate.
- Wood compartment.
- Ceramic glass resistant up to 750° C.
- Hogar en fundición con sistema de post combustión.
- Revestimiento externo de mayólica y acero.
- Puerta de hierro fundido.
- Plancha de fundición pulida.
- Compartimento para la leña.
- Cristal cerámico resistente hasta 750° C.
- Foyer en fonte avec système post combustion.
- Revêtement extérieur en acier et en faïence.
- Porte en fonte.
- Plaque en fonte polie.
- Compartiment de rangement bois.
- Vitre céramique résistante à 750° C.

**COLORI**

Bianco Infinity

**DATI TECNICI**

 570x950x560	 Ghisa
 135	 78,1
 340x245	 2,4
 380x325x350	 130 S

**CERTIFICAZIONI****BlmSchV****TECNOLOGIA**







PIETRA NATURALE

# ASIA BII

**A+** | 6,0 kW-N | 172 m<sup>3</sup>**PLUS**

- Focolare in ghisa con sistema di post combustione.
  - Rivestimento esterno in pietra naturale.
  - Porta in ghisa smaltata.
  - Vano porta legna.
  - Vetro ceramico resistente fino a 750° C.
- Hearth in cast iron with post combustion system.
  - External facing in natural stone.
  - Enamelled cast iron door.
  - Wood compartment.
  - Ceramic glass resistant up to 750° C.
- Foyer en fonte avec système post combustion.
  - Revêtement extérieur en pierre.
  - Porte en fonte émaillée.
  - Compartiment de rangement bois.
  - Vitre céramique résistante à 750° C.
  - **Flamme Verte: Appareil de class 7★**
- Feuerraumverkleidung aus Gusseisen mit Doppelverbrennung.
  - Äußere Verkleidung aus Naturstein.
  - Tür aus emailliertem Gusseisen.
  - Holzlagerfach.
  - Keramikglas bis 750° C wärmebeständig.
- Hogar en fundición con sistema de post combustión.
  - Revestimiento externo en piedra natural.
  - Puerta de fundición esmaltada.
  - Compartimento para la leña.
  - Cristal cerámico resistente hasta 750° C.

**DATI TECNICI**

 438x930x470	 Ghisa
 159	% 81,3
 230x232	 1,7
 270x328x315	Ø 120 S

**CERTIFICAZIONI****15a B-VG****BImSchV****TECNOLOGIA**

PIETRA NATURALE

# ESTER BII

**A** | 7,5 kW-N | 215 m<sup>3</sup>**PLUS**

- Rivestimento esterno in pietra naturale.
- Porta in ghisa.
- Rivestimento interno del focolare in ghisa-Nordiker con post combustione.
- Regolazione della griglia fuoco.
- Cassetto portacenere a scomparsa.
- Possibilità di prendere all'esterno l'aria comburente.
- Vetro ceramico resistente fino a 750° C.







- External facing in natural stone
- Door in cast iron.
- Internal facing of the hearth in cast iron and Nordiker with post combustion.
- Fire grate adjustment.
- Concealed ash drawer.
- External air intake.
- Ceramic glass resistant up to 750° C.

- Revêtement extérieur en pierre.
- Porte en fonte.
- Revêtement intérieur du foyer en fonte/ Nordiker avec post combustion.
- Réglage de la grille feux.
- Tiroir et cendrier escamotable.
- Possibilité de prendre l'air comburant de l'extérieur.
- Vitre céramique résistante à 750° C.
- Flamme Verte: Appareil de class 7★

- Äußere Verkleidung aus Naturstein.
- Tür aus Gusseisen.
- Innenbekleidung des Feuerraums aus Gusseisen-Nordiker mit Doppelverbrennung.
- Einstellung des Feuerrosts.
- Unsichtbare Ascheschublade.
- Möglichkeit, die Verbrennungsluft von außen zuzuleiten.
- Keramikglas bis 750° C wärmebeständig.

- Revestimiento externo en piedra natural.
- Puerta de hierro fundido.
- Revestimiento interior del hogar de fundición y Nordiker con post combustión.
- Regulación de la rejilla de fuego.
- Cajón cenicero extraíble.
- Posibilidad de tomar el aire de la combustión del exterior.
- Cristal cerámico resistente hasta 750° C.

**DATI TECNICI**

 540x950x478	 Ghisa-Nordiker
 243	% 80
 300x350	 2,2
 295x390x300	Ø 130 S

**CERTIFICAZIONI****15a B-VG****BImSchV****TECNOLOGIA**

PIETRA NATURALE



# ESTER FORNO EVO

**A+** | 8,2 kW-N | 235 m<sup>3</sup>

## PLUS

- Rivestimento esterno in pietra naturale.
  - Porta in ghisa.
  - Rivestimento interno del focolare in ghisa-Nordiker con post combustione.
  - Cassetto portacenere a scomparsa.
  - Forno in acciaio smaltato porcellanato da 22 l.
  - Vetro ceramico resistente fino a 750° C.
- External facing in natural stone.
  - Door in cast iron.
  - Internal facing of the hearth in cast iron and Nordiker with post combustion.
  - Concealed ash drawer.
  - Porcelain enamelled steel oven 22 l.
  - Ceramic glass resistant up to 750° C.
- Revêtement extérieur en pierre.
  - Porte en fonte.
  - Revêtement intérieur du foyer en fonte/ Nordiker avec post combustion.
  - Tiroir et cendrier escamotable.
  - Four en acier émaillé porcelainé de 22 l.
  - Vitre céramique résistante à 750° C.
  - **Flamme Verte: Appareil de class 7★**
- Äußere Verkleidung aus Naturstein.
  - Tür aus Gusseisen.
  - Innenbekleidung des Feuerraums aus Gusseisen-Nordiker mit Doppelverbrennung.
  - Unsichtbare Ascheschublade.
  - Ofen aus porzellan-emailliertem Stahl mit 22 l Inhalt.
  - Keramikglas bis 750° C wärmebeständig.
- Revestimiento externo en piedra natural.
  - puerta de hierro fundido.
  - Revestimiento interior del hogar de fundición y Nordiker con post combustión.
  - Cajón cenicero extraíble.
  - Horno de acero esmaltado de porcelana de 22 l.
  - Cristal cerámico resistente hasta 750° C.











CONTO TERMICO

Per maggiori informazioni consultare il nostro sito:

[www.lanordica-extraflame.com](http://www.lanordica-extraflame.com)

## DATI TECNICI

 540x1300x478	 Ghisa-Nordiker
 317	 86,7
 300x340	 2,2
 295x315x300	 130 S
 268x238x338	



## CERTIFICAZIONI

15a B-VG

BImSchV



## TECNOLOGIA

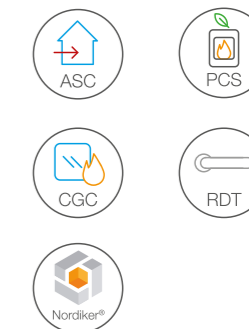

# MARIAROSA

**A+** | 8,6 kW-N | 246 m<sup>3</sup>



**CONTO TERMICO**

Per maggiori informazioni consultare il nostro sito:

www.lanordica-extraflame.com



Liberty Bordeaux

## COLORI



Liberty Pergamena Antico



Pietra Naturale

## PLUS

- Stufa in ghisa smaltata.
- Porta fuoco in ghisa con vetro panoramico.
- Accumulo in materiale refrattario di 30 Kg.
- Cassetto cenere estraibile.
- Cassettone porta legna.
- Aria primaria e secondaria regolabile, terziaria prearata con sistema di post combustione.
- Enamelled cast-iron stove
- Cast iron fire door with panoramic glass
- 30 Kg refractory material storage
- Removable ash box
- Wood drawer
- Adjustable primary and secondary air, pre-calibrated tertiary air with post combustion system
- Poêle en fonte émaillée
- Porte du foyer en fonte avec vitre panoramique
- Réservoir en matériau réfractaire de 30 kg
- Tiroir à cendres extractible
- Tiroir de rangement du bois
- L'air primaire et secondaire sont réglables, tandis que l'air tertiaire est pré-étalonné avec un système de postcombustion
- Flamme Verte: Appareil de class 7★

- Ofen aus emailliertem Gusseisen
- Feuertür aus Gusseisen mit Panoramaglas
- Einbau von 30 kg Schamottestein
- Herausziehbarer Aschenkasten
- Große Holzschublade
- Verstellbare Primär und Sekundärluft, voraustarierte Tertiärluft mit Nachverbrennungssystem
- Estufa de fundición esmaltada
- Puerta fuego de fundición con cristal panorámico
- Acumulador de material refractario de 30 kg
- Cajón para la recogida de cenizas extraíble
- Cajón grande para la leña
- Aire primario y secundario regulable, terciario precalibrado con sistema de post-combustión

## DATI TECNICI

	1030x851x650		Ghisa
	217 kg Mod. BO-PE 237 kg Mod. PT		% 87,6
	223x265		2,3
	270x320x362		Ø 150 S/P



## CERTIFICAZIONI

**15a B-VG**

**BImSchV**



## TECNOLOGIA



# MARIAROSA - MAIOLICA

**A+** | 8,6 kW-N | 246 m<sup>3</sup>



**CONTO TERMICO**

Per maggiori informazioni consultare il nostro sito:

www.lanordica-extraflame.com



Maiolica Tortora

## COLORI



Maiolica Bordeaux



Maiolica Bianco Infinity

## PLUS

- Stufa in ghisa smaltata.
- Porta fuoco in ghisa con vetro panoramico.
- Accumulo in materiale refrattario di 30 Kg.
- Cassetto cenere estraibile.
- Cassettone porta legna.
- Aria primaria e secondaria regolabile, terziaria prearata con sistema di post combustione.
- Enamelled cast-iron stove
- Cast iron fire door with panoramic glass
- 30 Kg refractory material storage
- Removable ash box
- Wood drawer
- Adjustable primary and secondary air, pre-calibrated tertiary air with post combustion system
- Poêle en fonte émaillée
- Porte du foyer en fonte avec vitre panoramique
- Réservoir en matériau réfractaire de 30 kg
- Tiroir à cendres extractible
- Tiroir de rangement du bois
- L'air primaire et secondaire sont réglables, tandis que l'air tertiaire est pré-étalonné avec un système de postcombustion
- Flamme Verte: Appareil de class 7★

- Ofen aus emailliertem Gusseisen
- Feuertür aus Gusseisen mit Panoramaglas
- Einbau von 30 kg Schamottestein
- Herausziehbarer Aschenkasten
- Große Holzschublade
- Verstellbare Primär und Sekundärluft, voraustarierte Tertiärluft mit Nachverbrennungssystem
- Estufa de fundición esmaltada
- Puerta fuego de fundición con cristal panorámico
- Acumulador de material refractario de 30 kg
- Cajón para la recogida de cenizas extraíble
- Cajón grande para la leña
- Aire primario y secundario regulable, terciario precalibrado con sistema de post-combustión

## DATI TECNICI

	1030x851x650		Ghisa
	239		% 87,6
	223x265		2,3
	270x320x362		Ø 150 S/P



## CERTIFICAZIONI

**15a B-VG**

**BImSchV**



## TECNOLOGIA

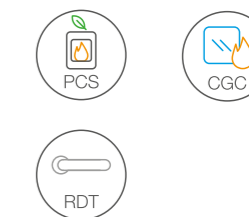

ROSSELLA 

LIBERTY PERGAMENA ANTICO

# ROSSELLA R1 BII

**A** | 8,8 kW-N | 252 m<sup>3</sup>



## PLUS

- Focolare in ghisa con sistema di post combustione.
- Rivestimento esterno in maiolica o pietra naturale.
- Porte e testata in ghisa smaltata.
- Vetro ceramico resistente fino a 750° C.
- Hearth in cast iron with post combustion system.
- External facing in majolica or in natural stone.
- Doors and top in cast iron.
- Ceramic glass resistant up to 750° C.
- Foyer en fonte avec système post combustion.
- Revêtement extérieur en faïence ou en pierre.
- Portes et élément supérieur en fonte émaillée.
- Vitre céramique résistante à 750° C.
- **Flamme Verte: Appareil de class 7★**
- Feuerraumverkleidung aus Gusseisen mit Doppelverbrennung.
- Außenverkleidung aus Majolika oder Naturstein.
- Türen und Kopf aus emailliertem Gusseisen.
- Keramikglas bis 750° C wärmebeständig.
- Hogar en fundición con sistema de post combustión.
- Revestimiento externo de mayólica o piedra natural.
- Puerta y cabecera de fundición esmaltada.
- Cristal cerámico resistente hasta 750° C.

## COLORI



Liberty Bianco Infinity











Liberty Bordeaux



Pietra Naturale

## DATI TECNICI

 578x915x586	 Ghisa
 155 Mod. BO-PE-BIN 170 Mod. PT	 80
 315x285	 2,4
 377x420x385	 130 S



## CERTIFICAZIONI

**15a B-VG**

**BImSchV**



## TECNOLOGIA







LIBERTY BORDEAUX

# ROSSELLA PLUS

**A+** | 8,0 kW-N | 229 m<sup>3</sup>

## PLUS

- Focolare in ghisa con sistema di post combustione.
- Rivestimento esterno in maiolica.
- Porta, testata e basamento in ghisa smaltata.
- Cassetto porta legna estraibile.
- Vetro ceramico resistente fino a 750° C.

- Hearth in cast iron with post combustion system.
- External facing in majolica.
- Enamelled cast iron top, door and base.
- Extractable wood drawer.
- Ceramic glass resistant up to 750° C.

- Foyer en fonte avec système post combustion.
- Revêtement extérieur en faïence.
- Porte, élément supérieur et bâti en fonte émaillé.
- Tiroir à bois amovible.
- Vitre céramique résistante à 750° C.
- Flamme Verte: Appareil de class 7★

- Feuerraumverkleidung aus Gusseisen mit Doppelverbrennung.
- Äußere Verkleidung aus Majolika.
- Tür, Kopf und Sockel aus emailliertem Gusseisen.
- Herausziehbare Holzschublade.
- Keramikglas bis 750° C wärmebeständig.

- Hogar en fundición con sistema de post combustión.
- Revestimiento exterior de mayólica.
- Puerta, cabecera y base de fundición esmaltada.
- Cajón extraíble por la leña.
- Cristal cerámico resistente hasta 750° C.

## COLORI









Liberty Pergamena Antico



Pietra Naturale

## DATI TECNICI

 559x915x536	 Ghisa
 137 mod. BO-PE 156 mod. PT	% 80,9
 355x245	 2,3
 374x325x350	Ø 130 S



## CERTIFICAZIONI

**15a B-VG**

**BImSchV**



## TECNOLOGIA



LIBERTY PERGAMENA ANTICO



# ROSSELLA PLUS FORNO EVO

**A+** | 9,1 kW-N | 260 m<sup>3</sup>

## PLUS

- Focolare in ghisa con sistema di post combustione.
  - Rivestimento esterno in maiolica o pietra naturale.
  - Porta, testata e basamento in ghisa smaltata.
  - Cassetto porta legna estraibile.
  - Forno smaltato da 37 l.
  - Vetro ceramico resistente fino a 750° C.
- Feuerraumverkleidung aus Gusseisen mit Doppelverbrennung.
  - Außenverkleidung aus Majolika oder Naturstein.
  - Tür, Kopf und Sockel aus emailliertem Gusseisen.
  - Herausziehbare Holzschublade.
  - Emaillierter Ofen mit 37 l Inhalt.
  - Keramikglas bis 750° C wärmebeständig.
- Hearth in cast iron with post combustion system.
  - External facing in majolica or in natural stone.
  - Enamelled cast iron top, door and base.
  - Extractable wood drawer.
  - Enamelled oven 37 l.
  - Ceramic glass resistant up to 750° C.
- Foyer en fonte avec système post combustion.
  - Revêtement extérieur en faïence ou en pierre.
  - Porte, élément supérieur et bâti en fonte émaillé.
  - Tiroir à bois amovible.
  - Four émaillé de 37 l.
  - Vitre céramique résistante à 750° C.
  - Flamme Verte: Appareil de class 7★
- Hogar en fundición con sistema de post combustión.
  - Revestimiento externo de mayólica o piedra natural.
  - Puerta, cabecera y base de fundición esmaltada.
  - Cajón extraíble por la leña.
  - Horno esmaltado de 37 l.
  - Cristal cerámico resistente hasta 750° C.

## COLORI











Liberty Bordeaux



Pietra Naturale

## DATI TECNICI

	559x1359x536		Ghisa
	195 mod. BO-PE 219 mod. PT		86
	355x245		2,4
	379x370x327		130 S
	330x300x370		



## CERTIFICAZIONI

15a B-VG

BImSchV



## TECNOLOGIA



CONTO TERMICO

Per maggiori informazioni  
consultare il nostro sito:

www.lanordica-extraflame.com

LIBERTY PERGAMENA ANTICO

# FULVIA

**A+** | 6,0 kW-N | 172 m<sup>3</sup>**PLUS**

- Focolare in ghisa.
- Rivestimento esterno in maiolica o pietra naturale.
- Porte e testata in ghisa smaltata.
- Vetro ceramico resistente fino a 750° C.
- Cast iron hearth.
- External facing in majolica or in natural stone.
- Doors and top in cast iron.
- Ceramic glass resistant up to 750° C.
- Foyer en fonte.
- Revêtement extérieur en faïence ou en pierre.
- Portes et élément supérieur en fonte émaillée.
- Vitre céramique résistante à 750° C.
- Flamme Verte: Appareil de class 7★
- Feuerstelle aus Gusseisen.
- Außenverkleidung aus Majolika oder Naturstein.
- Türen und Kopf aus emailliertem Gusseisen.
- Keramikglas bis 750° C wärmebeständig.
- Hogar de fundición.
- Revestimiento externo de mayólica o piedra natural.
- Puertas y cabecera de fundición esmaltada.
- Cristal cerámico resistente hasta 750° C.









**COLORI**

Liberty Bordeaux



Pietra Naturale

**DATI TECNICI**

 488x862x477	 Ghisa
 109 mod. BO-PE 119 mod. PT	 82
 210x255	 1,7
 273x370x320	 120 S

**CERTIFICAZIONI****15a B-VG****BImSchV****TECNOLOGIA**

# FULVIA FORNO

**A+** | 6,0 kW-N | 172 m<sup>3</sup>

## PLUS

- Focolare in ghisa.
  - Rivestimento esterno in maiolica o pietra naturale.
  - Porte e testata in ghisa smaltata.
  - Forno smaltato da 19 l.
  - Vetro ceramico resistente fino a 750° C.
- Cast iron hearth.
  - External facing in majolica or in natural stone.
  - Doors and top in cast iron.
  - Enamelled oven 19 l.
  - Ceramic glass resistant up to 750° C.
- Foyer en fonte.
  - Revêtement extérieur en faïence ou en pierre.
  - Portes et élément supérieur en fonte émaillée.
  - Four émaillé de 19 l.
  - Vitre céramique résistante à 750° C.
  - Flamme Verte: Appareil de class 7★
- Feuerstelle aus Gusseisen.
  - Außenverkleidung aus Majolika oder Naturstein.
  - Türen und Kopf aus emailiertem Gusseisen.
  - Emailierter Ofen mit 19 l Inhalt.
  - Keramikglas bis 750° C wärmebeständig.
- Hogar de fundición.
  - Revestimiento externo de mayólica o piedra natural.
  - Puertas y cabecera de fundición esmaltada.
  - Horno esmaltado de 19 l.
  - Cristal cerámico resistente hasta 750° C.

PIETRA NATURALE

## COLORI











Liberty Bordeaux



Liberty Pergamena Antico

## DATI TECNICI

 488x1288x477	 Ghisa
 155 mod. BO-PE 173 mod. PT	 82
 210x255	 1,7
 227x296x290	 120 S



## CERTIFICAZIONI

**15a B-VG**

**BImSchV**



## TECNOLOGIA



# DORELLA L8 X

**A** | 8,0 kW-N | 195 m<sup>3</sup>

## PLUS

- Focolare in ghisa.
- Rivestimento esterno in maiolica o pietra naturale.
- Porte e testata in ghisa smaltata.
- Vetro ceramico resistente fino a 750° C.

- Cast iron hearth.
- External facing in majolica or in natural stone.
- Doors and top in cast iron.
- Ceramic glass resistant up to 750° C.

- Foyer en fonte.
- Revêtement extérieur en faïence ou en pierre.
- Portes et élément supérieur en fonte émaillée.
- Vitre céramique résistante à 750° C.

- Feuerstelle aus Gusseisen.
- Außenverkleidung aus Majolika oder Naturstein.
- Türen und Kopf aus emailliertem Gusseisen.
- Keramikglas bis 750° C wärmebeständig.

- Hogar de fundición.
- Revestimiento externo de mayólica o piedra natural.
- Puerta y cabecera de fundición esmaltada.
- Cristal cerámico resistente hasta 750° C.

## COLORI



Liberty Bordeaux



Pietra Naturale

## DATI TECNICI

465x845x491	Ghisa
90 mod. BO-PE 102 mod. PT	% 77
214x213	2,1
285x366x300	Ø 120 S



## TECNOLOGIA



F.D.G.

LIBERTY PERGAMENA ANTICO



# GEMMA

**A+** | 6,0 kW-N | 172 m<sup>3</sup>



## PLUS

- Focolare in ghisa.
- Rivestimento esterno in maiolica o pietra naturale.
- Porte e testata in ghisa smaltata.
- Vetro ceramico resistente fino a 750° C.
- Cast iron hearth.
- External facing in majolica or in natural stone.
- Doors and top in cast iron.
- Ceramic glass resistant up to 750° C.
- Foyer en fonte.
- Revêtement extérieur en faïence ou en pierre.
- Portes et élément supérieur en fonte émaillée.
- Vitre céramique résistante à 750° C.
- **Flamme Verte: Appareil de class 7★**
- Feuerstelle aus Gusseisen.
- Außenverkleidung aus Majolika oder Naturstein.
- Türen und Kopf aus emailliertem Gusseisen.
- Keramikglas bis 750° C wärmebeständig.
- Hogar de fundición.
- Revestimiento externo de mayólica o piedra natural.
- Puertas y cabecera de fundición esmaltada.
- Cristal cerámico resistente hasta 750° C.

## COLORI



Elegance Bianco Infinity



Pietra Naturale



Liberty Pergamena Antico

## DATI TECNICI

460x840x495	Ghisa
85 mod. BO-PE-BIN 98 mod. PT	82,2
220x215	1,7
220x370x290	120 S



## CERTIFICAZIONI

**15a B-VG**

**BImSchV**



## TECNOLOGIA



F.D.G.

ELEGANCE BORDEAUX





# GEMMA FORNO

**A+** | 7,2 kW-N | 206 m<sup>3</sup>



CONTO TERMICO

Per maggiori informazioni consultare il nostro sito:

www.lanordica-extraflame.com

## PLUS

- Rivestimento esterno in maiolica o pietra naturale.
- Focolare in ghisa.
- Forno smaltato da 19 l.
- Porte e testata in ghisa smaltata.
- Vetro ceramico resistente fino a 750° C.

- External facing in majolica or in natural stone.
- Cast iron hearth.
- Enamelled oven 19 l.
- Doors and top in cast iron.
- Ceramic glass resistant up to 750° C.

- Revêtement extérieur en faïence ou en pierre.
- Foyer en fonte.
- Four émaillé de 19 l.
- Portes et élément supérieur en fonte émaillée.
- Vitre céramique résistante à 750° C.
- Flamme Verte: Appareil de class 7★

- Außenverkleidung aus Majolika oder Naturstein.
- Feuerstelle aus Gusseisen.
- Emaillierter Ofen mit 19 l Inhalt.
- Türen und Kopf aus emailliertem Gusseisen.
- Keramikglas bis 750° C wärmebeständig.

- Revestimiento externo de mayólica o piedra natural.
- Hogar de fundición.
- Hornos esmaltado de 19 l.
- Puertas y cabecera de fundición esmaltada.
- Cristal cerámico resistente hasta 750° C.

## COLORI











Elegance Bianco Infinity



Pietra Naturale

## DATI TECNICI

	460x1207x495		Ghisa
	121 mod. BO-BIN 134 mod. PT		85,3
	220x215		2
	220x370x290		120 S
	227x296x290		



## CERTIFICAZIONI

15a B-VG

BImSchV



## TECNOLOGIA



# TEA

**A+** | 6,6 kW-N | 189 m<sup>3</sup>



## PLUS

- Rivestimento esterno in acciaio porcellanato.
- Basamento, testata e porta in ghisa.
- Vetro ceramico resistente fino a 750° C.
- Cassetto cenere estraibile.
- Aria primaria e secondaria regolabile, aria terziaria pretrata con sistema di post combustione.
- Außenverkleidung aus porzellan-emailiertem Stahl.
- Sockel, Kopf und Tür aus Gusseisen.
- Keramikglas bis 750° C wärmebeständig.
- Unsichtbare Ascheschublade.
- Verstellbare primär und Sekundärluft, voraustarierte Tertiärluft mit Nachverbrennungssystem.
- Revestimiento externo de acero esmaltado.
- Base, cabecera y puerta de fundición.
- Cristal cerámico resistente hasta 750° C.
- Cajón cenicero extraíble.
- Aire primaria y secundaria regulable, aire terciaria con sistema de postcombustion precalibrado.
- Enamelled external facing.
- Base, top and door in cast iron.
- Ceramic glass resistant up to 750° C.
- Concealed ash drawer.
- Adjustable primary and secondary air, preset tertiary air with post combustion system.
- Revêtement extérieur en acier emailé.
- Bâti, élément supérieur et porte en fonte.
- Vitre céramique résistante à 750° C.
- Tiroir et cendrier escamotable.
- Air primaire et secondaire réglables, air tertiaire pré-calibré avec système post combustion.
- Flamme Verte: Appareil de class 7★

## COLORI



Nero Antracite

## DATI TECNICI

414x832x419

Ghisa-Refrattario

77 kg

82 %

220x215

1,8

228x365x278

120 S



## CERTIFICAZIONI

15a B-VG

BImSchV



## TECNOLOGIA



BIANCO

TEA

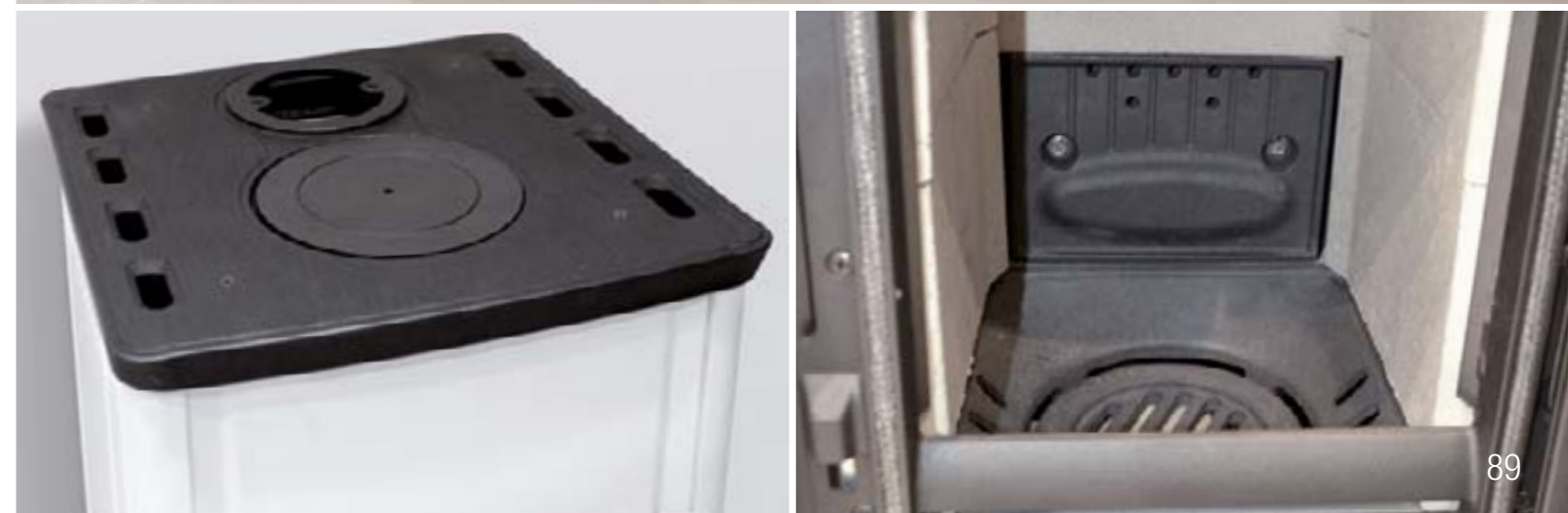



BRUCIATUTTO 



NERO

COLORI



Verde



NERO

COLORI



Verde

## SUPER MAX

**A** | 6,0 kW-N | 172 m<sup>3</sup>

PLUS

- Rivestimento esterno in acciaio smaltato.
- Porta con apertura a libro.
- Scuotigriglia azionabile dall'esterno.
- Focolare in ghisa.
- Porte e testata in ghisa smaltata.
- Maniglie in ottone cromato.
- Vetro ceramico resistente fino a 750° C.

- Enamelled steel external facing
- Bi-fold doors.
- External grid shaker.
- Cast iron hearth.
- Doors and top in cast iron.
- Chrome brass handles.
- Ceramic glass resistant up to 750° C.

- Revêtement extérieur en acier émaillé.
- Porte à deux vantaux.
- Dispositif pour secouer la grille, actionnable de l'extérieur.
- Foyer en fonte.
- Portes et élément supérieur en fonte émaillé.
- Poignée en laiton chromé.
- Vitre céramique résistante à 750° C.
- **Flamme Verte: Appareil de class 7★**







- Außenverkleidung aus emailliertem Stahl.
- 90° Türöffnung.
- Rostrüttler von außen zu betätigen.
- Feuerstelle aus Gusseisen.

- Türen und Kopf aus emailliertem Gusseisen.
- Handgriffe aus verchromtem Messing.
- Keramikglas bis 750° C wärmebeständig.

- Revestimiento externo de acero esmaltado.
- Puerta con apertura plegable.
- Sacudidor de rejilla accionable desde el exterior.
- Hogar de fundición.
- Puertas y cabecera de fundición esmaltada.
- Tiradores de latón cromado.
- Cristal cerámico resistente hasta 750° C.



DATI TECNICI

 402x811x482	 Ghisa
 75	% 80,3
 215x175	 1,9
 215x315x285	Ø 120 S



CERTIFICAZIONI

15a B-VG

BlmSchV



TECNOLOGIA



## SUPER JUNIOR

**A** | 5,0 kW-N | 143 m<sup>3</sup>

PLUS

- Rivestimento esterno in acciaio smaltato.
- Porta con apertura a libro.
- Scuotigriglia azionabile dall'esterno.
- Focolare in ghisa.
- Porte e testata in ghisa smaltata.
- Maniglie in ottone cromato.
- Vetro ceramico resistente fino a 750° C.

- Enamelled steel external facing
- Bi-fold doors.
- External grid shaker.
- Cast iron hearth.
- Doors and top in cast iron.
- Chrome brass handles.
- Ceramic glass resistant up to 750° C.

- Revêtement extérieur en acier émaillé.
- Porte à deux vantaux.
- Dispositif pour secouer la grille, actionnable de l'extérieur.
- Foyer en fonte.
- Portes et élément supérieur en fonte émaillé.
- Poignée en laiton chromé.
- Vitre céramique résistante à 750° C.
- **Flamme Verte: Appareil de class 7★**







- Außenverkleidung aus emailliertem Stahl.
- 90° Türöffnung.
- Rostrüttler von außen zu betätigen.
- Feuerstelle aus Gusseisen.

- Türen und Kopf aus emailliertem Gusseisen.
- Handgriffe aus verchromtem Messing.
- Keramikglas bis 750° C wärmebeständig.

- Revestimiento externo de acero esmaltado.
- Puerta con apertura plegable.
- Sacudidor de rejilla accionable desde el exterior.
- Hogar de fundición.
- Puertas y cabecera de fundición esmaltada.
- Tiradores de latón cromado.
- Cristal cerámico resistente hasta 750° C.



DATI TECNICI

 360x771x419	 Ghisa
 64	% 80
 215x175	 1,5
 206x280x260	Ø 120 S



CERTIFICAZIONI

15a B-VG

BlmSchV



TECNOLOGIA



# MIGNON

**E** | 4,0 kW-N | 115 m<sup>3</sup>

## PLUS

- Rivestimento esterno in acciaio smaltato.
- Scuotigriglia azionabile dall'esterno.
- Maniglie cromate.
- Testata in ghisa smaltata.
- Enamelled steel external facing.
- External grid shaker.
- Chrome-plated handles.
- Enamelled cast iron top.
- Revêtement extérieur en acier émaillé.
- Dispositif pour secouer la grille, actionnable de l'extérieur.
- Poignées chromées.
- Élément supérieur en fonte émaillée.
- Außenverkleidung aus emailliertem Stahl.
- Rostrüttler von außen zu betätigen.
- Verchromte Griffe.
- Kopf aus emailliertem Gusseisen.
- Revestimiento externo de acero esmaltado.
- Sacudidor de rejilla accionable desde el exterior.
- Tiradores cromados.
- Cabecera de fundición.

## COLORI



Brown



Bianco

## DATI TECNICI

378x817x417

Refrattario

56 kg

53,5 %

190x165

1,8

240x405x235

100 S



## TECNOLOGIA



## SERIE CUCINE

Le cucine a legna prodotte con i migliori materiali, realizzate con un design sobrio ed elegante in una gamma colori attuale e raffinata, sono uno splendido complemento d'arredo con cui riscoprire il piacere di cucinare.

### COOKERS RANGE SERIES:

Made using top quality materials with a simple elegant design in a range of refined modern colours, the wood-fuelled kitchen ranges are a splendid interior design accessory to rediscover the pleasure of cooking.

### SÉRIE CUISINIÈRES:

Les cuisinières à bois produites avec les meilleurs matériaux, réalisées avec un design sobre et élégant dans une gamme de couleurs actuelle et raffinée, constituent un splendide complément d'ameublement pour redécouvrir le plaisir de cuisiner.

### SERIE KÜCHENHERDE:

Holzherde aus besten Materialien, im edlen und eleganten Design und mit aktueller und raffinierter Farbpalette, sind ein wunderbares Wohnaccessoire, das Sie die Freude am Kochen wieder entdecken lässt.

### SERIE COCINAS:

Las cocinas a leña producidas con los mejores materiales, realizadas con un diseño sobrio y elegante en una gama de colores actuales y refinados, un magnífico complemento de decoración con los que redescubrir el placer de cocinar.



# AMERICA

**A** | 11,6 kW-N | 333 m<sup>3</sup>

## PLUS

- Rivestimento esterno in ghisa smaltata.
  - Ampio focolare in ghisa-Nordiker.
  - Griglia fuoco in ghisa regolabile.
  - Porta fuoco con doppio vetro.
  - Grande forno smaltato da 78 l.
  - Telaio, piastra e cerchi in ghisa.
  - Cassettone porta legna con frontale in ghisa.
  - Griglia forno cromata di serie.
- External covering in Enamelled cast-iron.
  - Large cast iron hearth Nordiker.
  - Adjustable cast iron fire grate.
  - Double glass fire door.
  - Large enamelled oven 78 l.
  - Cast iron frame, plate and rings.
  - Wood drawer with cast iron front.
  - Chromed oven rack.
- Revêtement extérieur en fonte émaillée.
  - Large foyer en fonte Nordiker.
  - Grille foyer à fonte réglable.
  - Porte foyer avec double vitre.
  - Grand four émaillé de 78 l.
  - Châssis, plaque et cercles en fonte.
  - Tiroir de rangement bois avec partie frontale en fonte.
  - Equipé d'une grille chromée pour le four.









- Außenverkleidung aus emailliertem Gusseisen.
  - Breite Feuerstelle aus Nordiker-Gusseisen.
  - Feuerrost aus einstellbarem Gusseisen.
  - Feuertür mit Doppelglas.
  - Großer emaillierter Ofen mit 78 l Inhalt.
  - Rahmen, Platte und Ringe aus Gusseisen.
  - Große Holzschublade mit Vorderseite aus Gusseisen.
  - Ausgestattet mit Backofenrost.
- Revestimiento externo de fundición esmaltada.
  - Amplio hogar de fundición - Nordiker.
  - Rejilla de fuego de fundición regulable.
  - Puerta con cristal doble.
  - Horno gran esmaltado de 78 l.
  - Bastidor, plancha y aros de fundición.
  - Cajón gran para leña con frontal de fundición.
  - Equipada con rejilla de horno cromada.



 CUCINE



## DATI TECNICI

 1280x860x660	 Ghisa-Nordiker
 321	 76
 300x405	 3,5
 400x410x460	 160 S/P
 436x418x430	



## CERTIFICAZIONI

**15a B-VG**

**BImSchV**

## TECNOLOGIA

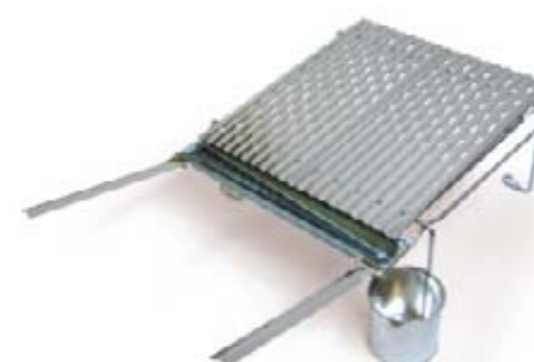
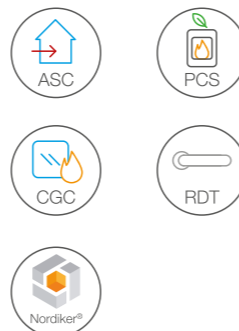

Di serie - Equipped with



Di serie - Equipped with



Di serie - Equipped with

# SUPREMA

**A** | 8,5 kW-N | 244 m<sup>3</sup>



## PLUS

- Rivestimento esterno in ghisa smaltata.
- Focolare in ghisa.
- Porta fuoco con doppio vetro.
- Grande forno smaltato da 78 l.
- Porte e piastra in ghisa.
- Cassettoni porta legna con frontale in ghisa.
- Griglia forno cromata di serie.

- External covering in Enamelled cast-iron.
- Cast iron hearth.
- Double glass fire door.
- Large enamelled oven 78 l.
- Cast iron doors and plate.
- Wood drawer with cast iron front.
- Chromed oven rack.

- Revêtement extérieur en fonte émaillée.
- Foyer en fonte.
- Porte foyer avec double vitre.
- Grand four émaillé de 78 l.
- Portes et plaque en fonte.
- Tiroir de rangement bois avec partie frontale en fonte.
- Équipé d'une grille chromée pour le four.
- Flamme Verte: Appareil de class 7★

- Außenverkleidung aus emailliertem Gusseisen.
- Feuerstelle aus Gusseisen.
- Feuertür mit Doppelglas.
- Großer emaillierter Ofen mit 78 l Inhalt.
- Türen und Platte aus Gusseisen.
- Große Holzschublade mit Vorderseite aus Gusseisen.
- Ausgestattet mit Backofenrost.

- Revestimiento externo de fundición esmaltada.
- Hogar de fundición.
- Puerta con cristal doble.
- Horno gran esmaltado de 78 l.
- Puertas y plancha de fundición.
- Cajón gran para leña con frontal de fundición.
- Equipada con rejilla de horno cromada.

## COLORI



Tortora



Twin Color\*

## DATI TECNICI

974x860x660	Ghisa
220	% 78
235x225	2,6
277x304x460	Ø 150 S/P
436x418x430	



## CERTIFICAZIONI

**15a B-VG**

**BImSchV**



## TECNOLOGIA



\* Fino ad esaurimento scorte / While stocks last / Jusqu'à épuisement des stocks / Solange der Vorrat reicht / Hasta agotar existencias



# MAMY

**A** | 8,7 kW-N | 249 m<sup>3</sup>

## PLUS

- Rivestimento esterno in ghisa smaltata.
- Focolare in ghisa.
- Griglia fuoco in ghisa.
- Porta fuoco con doppio vetro.
- Grande forno smaltato da 55 l.
- Porte e piastra in ghisa.
- Cassettone porta legna con frontale in ghisa.
- Griglia forno cromata di serie.







- External covering in Enamelled cast-iron.
- Cast iron hearth.
- Cast iron fire grate.
- Double glass fire door.
- Large enamelled oven 55 l.
- Cast iron doors and plate.
- Wood drawer with cast iron front.
- Chromed oven rack.

- Revêtement extérieur en fonte émaillé.
- Foyer en fonte.
- Grille foyer en fonte.
- Porte foyer avec double vitre.
- Grand four émaillé de 55 l.
- Portes et plaque en fonte.
- Tiroir de rangement bois avec partie frontale en fonte.
- Equipé d'une grille chromée pour le four.
- **Flamme Verte: Appareil de class 7★**

- Außenverkleidung aus emailliertem Gusseisen.
- Feuerstelle aus Gusseisen.
- Feuerrost aus Gusseisen.
- Feuertür mit Doppelglas.
- Großer emaillierter Ofen zu 55 l.
- Türen und Platte aus Gusseisen.
- Große Holzschublade mit Vorderseite aus Gusseisen.
- Ausgestattet mit Backofenrost.

- Revestimiento externo de fundición esmaltada.
- Hogar de fundición.
- Rejilla de fuego de fundición.
- Puerta con cristal doble.
- Horno gran esmaltado de 55 l.
- Puertas y plancha de fundición.
- Cajón gran para leña con frontal de fundición.
- Equipada con rejilla de horno cromada.

## DATI TECNICI

	880x860x660		Ghisa
	210	%	78
	235x225		2,7
	277x304x460	Ø	150 S/P
	307x418x430		



## CERTIFICAZIONI

**15a B-VG**

**BImSchV**



## TECNOLOGIA



# CUCINOTTA







**A** | 9,1 kW-N | 261 m<sup>3</sup>

## PLUS

- Rivestimento esterno in ghisa vetrificata.
  - Focolare in ghisa-Nordiker.
  - Griglia fuoco in ghisa regolabile.
  - Porta fuoco con doppio vetro.
  - Telaio, piastra e cerchi in ghisa.
  - Cassettone porta legna con frontale in ghisa.
- External facing in vitrified cast iron.
  - Cast iron hearth Nordiker.
  - Adjustable cast iron fire grate.
  - Double glass fire door.
  - Cast iron frame, plate and rings.
  - Wood drawer with cast iron front.
- Revêtement extérieur en fonte vitrifié.
  - Foyer en fonte Nordiker.
  - Grille foyer en fonte réglable.
  - Porte foyer avec double vitre.
  - Châssis, plaque et cercles en fonte.
  - Tiroir de rangement bois avec partie frontale en fonte.
- Außenverkleidung aus verglastem Gusseisen.
  - Feuerstelle aus Nordiker-Gusseisen.
  - Feuerrost aus einstellbarem Gusseisen.
  - Feuertür mit Doppelglas.
  - Rahmen, Platte und Ringe aus Gusseisen.
  - Große Holzschublade mit Vorderseite aus Gusseisen.
- Revestimiento externo de fundición vitrificada.
  - Hogar de fundición - Nordiker.
  - Rejilla de fuego de fundición regulable.
  - Puerta con cristal doble.
  - Bastidor, plancha y aros de fundición.
  - Cajón gran para leña con frontal de fundición.



## DATI TECNICI

 682x860x653	 Ghisa-Nordiker
 197	% 78
 405x325	 2,8
 423x346x475	Ø 150 S/P



## CERTIFICAZIONI

**15a B-VG**
**BImSchV**

## TECNOLOGIA

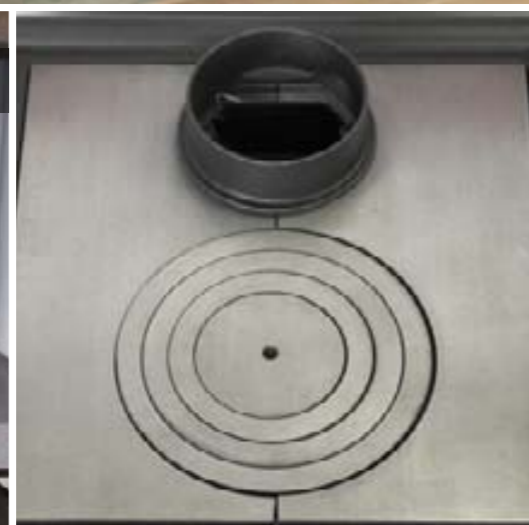
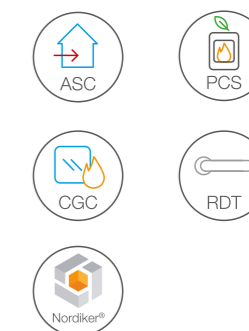



# VICENZA EVO

**A+** | 6 kW-N | 172 m<sup>3</sup>



## PLUS

- Focolare in ghisa-Nordiker.
  - Rivestimento in cristallo e in acciaio Inox satinato o smaltato.
  - Porta fuoco con triplo vetro.
  - Porta fuoco in ghisa.
  - Forno smaltato da 25 litri con luce.
  - Aria comburente BBC.
  - Regolazione automatica dell'aria primaria.
  - Piastra e cerchi in ghisa levigata.
  - Porte reversibili.
  - Possibilità di inserimento tra mobili.
  - Altezza top 3 cm.
  - Griglia forno cromata di serie.
- Option of fitting between furniture cabinets
  - Top thickness 3 cm.
  - Chromed oven rack
- Foyer en fonte Nordiker
  - Revêtement en cristal et en acier inox satiné ou émaillé
  - Porte foyer avec triple vitre
  - Porte foyer en fonte
  - Four de large dimension avec lumière
  - Capacité du four 25 l.
  - Air comburant BBC
  - Réglage automatique de l'air primaire
  - Plaque et cercles en fonte polie
  - Portes réversibles
  - Possibilité d'introduction entre les meubles
  - Épaisseur haut du poêle 3 cm.
  - Équipé d'une grille chromée pour le four
  - **Flamme Verte: Appareil de class 7★**
- Feuerstätte aus Gusseisen.
  - Großer Ofen mit Beleuchtung.
  - Ofeninhalt 25 l.
  - Verbrennungsluft BBC.
  - Automatische Primärlufteinstellung.
  - Platte und Ringe aus geschliffenem Gusseisen.
  - Austauschbarer Türanschlag.
  - Zwischen den Möbeln einfügbar.
  - Top - 3 cm dick.
  - Ausgestattet mit Backofenrost.
- Hearth in cast-iron and Nordiker
  - Glass and brushed or enamelled stainless steel finish
  - Triple glass fire door
  - Cast iron firedoor
  - Large oven with light
  - Oven capacity 25 l.
  - Combustion air BBC
  - Automatic adjustment of primary air
  - Top cooking plate and rings in polished cast-iron
  - Reversible doors
- Hogar de fundición-Nordiker.
  - Revestimiento de cristal y acero inoxidable satinado o esmaltado.
  - Puerta con triple vidrio.
  - Puerta fuego de fundición.
  - Horno de gran tamaño con luz.
  - Capacidad del horno 25 l.
  - Aire comburente BBC.
  - Regulación automática del aire primario.
  - Plancha y aros de fundición pulida.
  - Puertas reversibles.
  - Posibilidad de colocarlo entre muebles.
  - Altura parte de arriba cm.3.
  - Equipada con rejilla de horno cromada.

## COLORI



Nero Antracite



Inox

## DATI TECNICI

600x850-910x600	Ghisa-Nordiker
137	% 86
232x160	1,7
232x230x340	Ø 120 S/P - Lat. Dx/Sx
350x175x410	W 25



## CERTIFICAZIONI

**15a B-VG**

**BImSchV**



## TECNOLOGIA

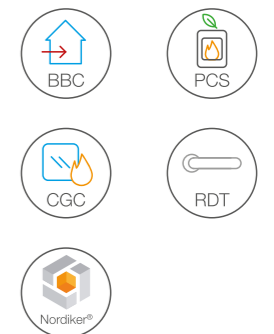

**4 cm**

Optional: altezza top 4 cm  
 Optional: Top thickness 4 cm  
 Optionnel: épaisseur haut du poêle 4 cm  
 Optional: Top - 4 cm dick  
 Opcional: parte de arriba altura cm.4





4 cm

Optional: altezza top 4 cm  
 Optional: Top thickness 4 cm  
 Optionnel: épaisseur haut du poêle 4 cm  
 Optional: Top - 4 cm dick  
 Opcional: parte de arriba altura cm.4

# VERONA

**A** | 8 kW-N | 229 m<sup>3</sup>

## PLUS

- Focolare in ghisa-Nordiker.
- Rivestimento in cristallo e acciaio inox satinato o smaltato.
- Porta fuoco con triplo vetro.
- Porta fuoco in ghisa.
- Ampio forno da 59 l con luce.
- Aria comburente BBC.
- Regolazione automatica dell'aria primaria.
- Piastra e cerchi in ghisa levigata.
- Porte reversibili.
- Possibilità di inserimento tra mobili.
- Altezza top 3 cm.
- Griglia forno cromata di serie.
- Hearth in cast-iron and Nordiker.
- Glass and brushed or enamelled stainless steel finish.
- Triple glass fire door.
- Cast iron firedoor.
- Large oven with light.
- Oven capacity 59 l
- Combustion air BBC.
- Automatic adjustment of primary air.
- Top cooking plate and rings in polished cast-iron.
- Reversible doors.
- Option of fitting between furniture cabinets.
- Top thickness 3 cm.
- Chromed oven rack.
- Foyer en fonte Nordiker.
- Revêtement en cristal et en acier inox satiné ou émaillé.
- Porte foyer avec triple vitre.
- Porte foyer en fonte.
- Four de large dimension avec lumière.
- Capacité du four 59 l.
- Air comburant BBC.
- Réglage automatique de l'air primaire.
- Plaque et cercles en fonte polie.
- Portes réversibles.
- Possibilité d'introduction entre les meubles.
- Épaisseur haut du poêle 3 cm.
- Équipé d'une grille chromée pour le four.
- **Flamme Verte: Appareil de class 7★**
- Feuerstelle aus Nordiker-Gusseisen.
- Verkleidung aus Kristallglas und entweder matten oder emaillierten Edelstahl.
- Feuertür mit Dreifachglas.
- Feuertür aus Gusseisen.
- Großer Ofen mit Beleuchtung.
- Ofeninhalt 59 l.
- Verbrennungsluft BBC.
- Automatische Primärlufteinstellung.
- Platte und Ringe aus geschliffenem Gusseisen.
- Austauschbarer Türanschlag.
- Zwischen den Möbeln einfügbar.
- Top - 3 cm dick.
- Ausgestattet mit Backofenrost.
- Hogar de fundición-Nordiker.
- Revestimiento de cristal y acero inoxidable satinado o esmaltado.
- Puerta con vidrio triple.
- Puerta fuego de fundición.
- Horno de gran tamaño con luz.
- Capacidad del horno 59 l.
- Aire comburente BBC.
- Regulación automática del aire primario.
- Plancha y aros de fundición pulida.
- Puertas reversibles.
- Posibilidad de colocarlo entre muebles.
- Altura parte de arriba cm.3.
- Equipada con rejilla de horno cromada.

## COLORI



Nero Antracite



Inox

## DATI TECNICI

	800x850-910x600		Ghisa-Nordiker
	161		78,4
	225x160		2,4
	220x147x337		150 S/P - Lat. Dx/Sx
	430x320x430		W 25



## CERTIFICAZIONI

**15a B-VG****BImSchV**

## TECNOLOGIA





# VERONA XXL

**A+** | 7 kW-N | 200 m<sup>3</sup>

NEW 2020

**PLUS**

- Rivestimento in acciaio inox o smaltato
- Possibilità di scelta completa per uscita fumi
- Porta fuoco in ghisa con doppio vetro
- Piastra e cerchi in ghisa levigata ad alto spessore
- Porte reversibili
- Grande focolare in Nordiker con ampia visione fuoco, possibilità uso di ceppi da 50 cm\*\*\*
- Possibilità inserimento tra i mobili senza kit opzionale
- Ampio forno smaltato da 68 litri, luce con comando di accensione ergonomico
- Porta forno con doppio vetro e guarnizioni in acciaio inox
- Revêtement en acier inox ou émaillé
- Toutes les solutions d'évacuation de la fumée sont possibles
- Porte de foyer en fonte à double vitrage
- Plaque et cercles en fonte polie très épaisse
- Portes réversibles
- Grand foyer en Nordiker avec ample vue sur le feu, possibilité d'utiliser des bûches de 50 cm\*\*\*
- Introduction possible entre les meubles sans kit en option
- Grand four émaillé de 68 litres, éclairage avec commande d'allumage ergonomique
- Porte du four à double vitrage et joints en acier inox
- Ofentür mit Doppelglas und Dichtungen aus Edelstahl
- Revestimiento en acero inoxidable o esmaltado
- Posibilidad de elección completa para salida de humos
- Puerta del hogar en fundición con doble cristal
- Placa y aros de fundición pulida de alto espesor
- Puertas reversibles
- Gran hogar en Nordiker con amplia visión de fuego, posibilidad de uso de tocones de 50 cm\*\*\*
- Posibilidad de montaje entre muebles sin kit opcional
- Amplio horno esmaltado de 68 litros, luz con mando ergonómico de encendido
- Puerta horno con doble cristal y juntas en acero inoxidable
- Stainless steel or enamelled
- Possibility of complete choice for smoke outlet
- Fire door in cast iron with double glass
- Plate and rims in polished thick cast iron
- Reversible doors
- Large hearth in Nordiker with wide fire vision, wood logs up to 50 cm\*\*\*
- Built-in Possibility between the furniture without any optional kit
- Large 68-liter enameled oven, ergonomic light control
- Double glass oven door and stainless steel gaskets
- Verkleidung aus Edelstahl oder emailiert
- Möglichkeit der vollständigen Auswahl für den Rauchauslass
- Feuertüre aus Gusseisen mit Doppelglas
- Platte und Ringe aus geschliffenem Gusseisen von hoher Dicke
- Umkehrbare Türen
- Großer Feuerraum aus Nordiker mit weiter Sicht auf das Feuer, Möglichkeit der Verwendung von 50 cm langen Holzscheiten\*\*\*
- Möglichkeit zum Einfügen zwischen Möbeln ohne optionales Kit
- Großer emailierter Ofen von 68 Litern, Beleuchtung mit ergonomischer Zündsteuerung

**COLORI**

Nero Antracite



Inox

**DATI TECNICI**

800x850-910x600

Ghisa-Nordiker

175

85,1

500x160

1,9

568x215x240

150

547x275x450

**CERTIFICAZIONI****15a B-VG****BlmSchV****TECNOLOGIA**

4 cm

- Optional: altezza top 4 cm
- Optional: Top thickness 4 cm
- Optionnel: épaisseur haut du poêle 4 cm
- Opcional: Top - 4 cm dick
- Opcional: parte de arriba altura cm.4

\*\*\* Fermo restando il rispetto dei dati di consumo orario del combustibile previsti per il modello / Respecting the indication of hourly consumption related to the model / Sans préjudice du respect des données de consommation horaires du combustible prévues pour le modèle / Vorbehaltlich der Daten des stündlichen Kraftstoffverbrauchs für das Modell / Sin perjuicio del cumplimiento de los datos de consumo por hora del combustible previstos para el modelo



# PADOVA

**A** | 8,0 kW-N | 229 m<sup>3</sup>

## PLUS

- Focolare in ghisa-Nordiker.
- Rivestimento in cristallo e acciaio inox satinato o smaltato.
- Porta fuoco con doppio vetro.
- Porta fuoco in ghisa.
- Facciata in ghisa.
- Ampio forno da 36 l con luce.
- Aria comburente BBC.
- Regolazione automatica dell'aria primaria.
- Piastra e cerchi in ghisa levigata.
- Possibilità di inserimento tra mobili.
- Altezza top 3 cm.
- Griglia forno cromata di serie.

- Hearth in cast-iron and Nordiker.
- Glass and brushed or enamelled stainless steel finish.
- Duple glass fire door.
- Cast iron firedoor.
- Cast iron facade.
- Large oven with light.
- Oven capacity 36 l.
- Combustion air BBC.
- Automatic adjustment of primary air.
- Top cooking plate and rings in polished cast-iron.
- Option of fitting between furniture cabinets.

- Top thickness 3 cm.
- Chromed oven rack.
- Foyer en fonte Nordiker.
- Revêtement en cristal et en acier inox satiné ou émaillé.
- Porte foyer avec double vitre.
- Porte foyer en fonte.
- Façade en fonte.
- Four de large dimension avec lumière.
- Capacité du four 36 l.
- Air comburant BBC.
- Réglage automatique de l'air primaire.
- Plaque et cercles en fonte polie.
- Possibilité d'introduction entre les meubles.
- Épaisseur haut du poêle 3 cm.
- Équipé d'une grille chromée pour le four.
- **Flamme Verte: Appareil de class 7★**

- Feuerstelle aus Nordiker Gusseisen.
- Verkleidung aus Kristallglas und entweder matten oder emaillierten Edelstahl.
- Feuertür mit Doppelglas.
- Feuertür aus Gusseisen.
- Ansichtseite aus Gusseisen.
- Großer Ofen mit Beleuchtung.
- Ofeninhalt 36 l.

- Verbrennungsluft BBC.
- Automatische Primärlufteinstellung.
- Platte und Ringe aus geschliffenem Gusseisen.
- Zwischen den Möbeln einfügbar.
- Top - 3 cm dick.
- Ausgestattet mit Backofenrost.

- Hogar de fundición-Nordiker.
- Revestimiento de cristal y acero inoxidable satinado o esmaltado.
- Puerta con cristal doble.
- Puerta fuego de fundición.
- Frontal de fundición.
- Horno de gran tamaño con luz.
- Capacidad del horno 36 l.
- Aire comburente BBC.
- Regulación automática del aire primario.
- Plancha y aros de fundición pulida.
- Posibilidad de colocarlo entre muebles.
- Altura parte de arriba cm.3.
- Equipada con rejilla de horno cromada.

## COLORI



Nero Antracite



Inox

## DATI TECNICI

900x850-910x600	Ghisa-Nordiker
174 kg	75 %
210x175	2,5
226x270x384	150 S/P - Lat. Dx
310x286x410	25 W



## CERTIFICAZIONI

**15a B-VG**

**BlmSchV**



## TECNOLOGIA

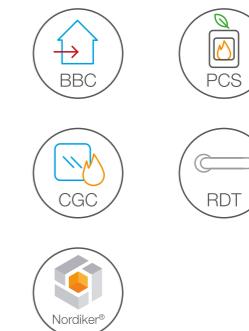

4 cm

Optional: altezza top 4 cm  
Optional: Top thickness 4 cm  
Optionnel: épaisseur haut du poêle 4 cm  
Optional: Top - 4 cm dick  
Opcional: parte de arriba altura cm.4

# ROSA XXL

**A+** | 8,5 kW-N | 244 m<sup>3</sup>

## PLUS

- Rivestimento esterno in acciaio porcellanato
- Porte e facciata in ghisa vetrificata
- Porta fuoco con doppio vetro
- Grande forno smaltato da 78 l
- Piastra e cerchi in ghisa levigata
- Focolare in refrattario
- Cassettoni porta legna
- Griglia forno cromata di serie

- Enamelled external facing
- Doors and facade in polished cast iron
- Double glass fire door
- Large enamelled oven 78 l
- Top cooking plate and rings in polished cast-iron
- Refractory hearth
- Wood drawer
- Chromed oven rack







- Revêtement extérieur en acier émaillé
- Portes et façade en fonte vitrifiée
- Porte foyer avec double vitre
- Grand four émaillé de 78 l
- Plaque et cercles en fonte polie
- Foyer en réfractaire
- Tiroir de rangement bois
- Équipé d'une grille chromée pour le four
- Flamme Verte: Appareil de class 7★

- Außenverkleidung aus porzellan-emailliertem Stahl
- Türen und Ansichtseite aus verglastem Gusseisen
- Feuertür mit Doppelglas
- Großer emaillierter Ofen mit 78 l Inhalt
- Platte und Ringe aus geschliffenem Gusseisen
- Feuerstelle aus Schamottstein
- Große Holzschublade
- Ausgestattet mit Backofenrost

- Revestimiento externo de acero esmaltado
- Puertas y frontal de fundición vitrificada
- Puerta con cristal doble
- Horno gran esmaltado de 78 l
- Plancha y aros de fundición pulida
- Hogar de refractario
- Cajón gran para la leña
- Equipada con rejilla de horno cromada

NERO ANTRACITE

## DATI TECNICI

	1074x861x669		Ghisa/Refrattario
	202	%	85
	225x210		2,3
	296x306x460	∅	150 S/P
	436x418x430		



## CERTIFICAZIONI

**15a B-VG**
**BImSchV**

 Flamme  
 VERTE

**HETAS**

## TECNOLOGIA



# ROSA XXL - MAIOLICA

**A+** | 8,5 kW-N | 244 m<sup>3</sup>

## PLUS

- Rivestimento esterno in maiolica.
- Porte e facciata in ghisa vetrificata.
- Porta fuoco con doppio vetro.
- Grande forno smaltato da 78 l.
- Piastra e cerchi in ghisa levigata.
- Focolare in refrattario.
- Cassettoni porta legna.
- Griglia forno cromata di serie.

- External facing in majolica.
- Doors and facade in polished cast iron.
- Double glass fire door.
- Large enamelled oven 78 l.
- Top cooking plate and rings in polished cast-iron.
- Refractory hearth.
- Wood drawer.
- Chromed oven rack.

- Revêtement extérieur en faïence.
- Portes et façade en fonte vitrifiée.
- Porte foyer avec double vitre.
- Grand four émaillé de 78 l.
- Plaque et cercles en fonte polie.
- Foyer en réfractaire.
- Tiroir de rangement bois.
- Equipé d'une grille chromée pour le four.
- **Flamme Verte: Appareil de class 7★**

- Äußere Verkleidung aus Majolika.
- Türen und Ansichtseite aus verglastem Gusseisen.
- Feuertür mit Doppelglas.
- Großer emaillierter Ofen mit 78 l Inhalt.
- Platte und Ringe aus geschliffenem Gusseisen.
- Feuerstelle aus Schamottstein.
- Große Holzschublade.
- Ausgestattet mit Backofenrost.

- Revestimiento exterior de mayólica.
- Puertas y frontal de fundición vitrificada.
- Puerta con cristal doble.
- Horno gran esmaltado de 78 l.
- Plancha y aros de fundición pulida.
- Hogar de refractario.
- Cajón gran para la leña.
- Equipada con rejilla de horno cromada.







BIANCO INFINITY

## COLORI



Bordeaux

## DATI TECNICI

	1074x861x669		Ghisa/Refrattario
	235	%	85
	225x210		2,3
	296x306x460	Ø	150 S/P
	436x418x430		



## CERTIFICAZIONI

**15a B-VG**
**BImSchV**

 Flamme VERTE

 HETAS

## TECNOLOGIA





# ROSA XXL - PETRA

**A+** | 8,5 kW-N | 244 m<sup>3</sup>



## PLUS

- Rivestimento esterno in pietra naturale.
- Porte e facciata in ghisa vetrificata.
- Porta fuoco con doppio vetro.
- Grande forno smaltato da 78 l.
- Piastra e cerchi in ghisa levigata.
- Focolare in refrattario.
- Cassettoni porta legna.
- Griglia forno cromata di serie.

- External facing in natural stone.
- Doors and facade in polished cast iron.
- Double glass fire door.
- Large enamelled oven 78 l.
- Top cooking plate and rings in polished cast-iron.
- Refractory hearth.
- Wood drawer.
- Chromed oven rack.







- Revêtement extérieur en pierre.
- Portes et façade en fonte vitrifiée.
- Porte foyer avec double vitre.
- Grand four émaillé de 78 l.
- Plaque et cercles en fonte polie.
- Foyer en réfractaire.
- Tiroir de rangement bois.
- Équipé d'une grille chromée pour le four.
- Flamme Verte: Appareil de class 7★

- Äußere Verkleidung aus Naturstein.
- Türen und Ansichtseite aus verglastem Gusseisen.
- Feuertür mit Doppelglas.
- Großer emaillierter Ofen mit 78 l Inhalt.
- Platte und Ringe aus geschliffenem Gusseisen.
- Feuerstelle aus Schamottstein.
- Große Holzschublade.
- Ausgestattet mit Backofenrost.

- Revestimiento externo en piedra natural.
- Puertas y frontal de fundición vitrificada.
- Puerta con cristal doble.
- Horno gran esmaltado de 78 l.
- Plancha y aros de fundición pulida.
- Hogar de refractario.
- Cajón gran para la leña.
- Equipada con rejilla de horno cromada.



## DATI TECNICI

	1074x861x669		Ghisa/Refrattario
	275	%	85
	225x210		2,3
	296x306x460	Ø	150 S/P
	436x418x430		



## CERTIFICAZIONI

15a B-VG

BImSchV



## TECNOLOGIA





NERO ANTRACITE



# ROSA L

**A+** | 8,1 kW-N | 232 m<sup>3</sup>

## PLUS

- Rivestimento esterno in acciaio porcellanato.
- Porte e facciata in ghisa vetrificata.
- Porta fuoco con doppio vetro.
- Forno smaltato panoramico da 55 l.
- Piastra e cerchi in ghisa levigata.
- Focolare in refrattario e ghisa.
- Cassettone porta legna.
- Griglia forno cromata di serie.

- Enamelled external facing.
- Doors and facade in polished cast iron.
- Double glass fire door.
- Panoramic enamelled oven 55 l.
- Top cooking plate and rings in polished cast-iron.
- Refractory and cast iron hearth.
- Wood drawer.
- Chromed oven rack.







- Revêtement extérieur en acier émaillé.
- Portes et façade en fonte vitrifiée.
- Porte foyer avec double vitre.
- Four émaillé panoramique de 55 l.
- Plaque et cercles en fonte polie.
- Foyer en réfractaire et fonte.
- Tiroir de rangement bois.
- Equipé d'une grille chromée pour le four.
- **Flamme Verte: Appareil de class 7★**

- Außenverkleidung aus porzellan-emailliertem Stahl.
- Türen und Ansichtseite aus verglastem Gusseisen.
- Feuertür mit Doppelglas.
- Panoramaofen emailliert zu 55 l.
- Platte und Ringe aus geschliffenem Gusseisen.
- Feuerstelle aus Schamottstein und Gusseisen.
- Große Holzschublade.
- Ausgestattet mit Backofenrost.

- Revestimiento externo de acero esmaltado.
- Puertas y fachada de fundición vitrificada.
- Puerta con vidrio doble.
- Horno panorámico esmaltado de 55 l.
- Plancha y aros de fundición pulida.
- Hogar de refractario y de fundición.
- Cajón grande para la leña.
- Equipada con rejilla de horno cromada.



## DATI TECNICI

	975x861x670		Ghisa/Refrattario
	192	%	84
	225x210		2,3
	296x306x460	Ø	150 S/P
	307x418x430		



## CERTIFICAZIONI

**15a B-VG**

**BlmSchV**



## TECNOLOGIA

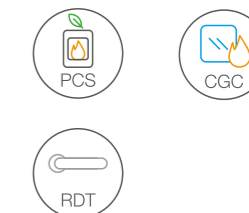

Optional



# ROSA REVERSE

**A+** | 8,1 kW-N | 232 m<sup>3</sup>



## PLUS

- Rivestimento esterno in maiolica
- Forno smaltato panoramico da 28 l
- Telaio in ghisa vetrificata
- Piastra e cerchi in ghisa levigata
- Ampio focolare in ghisa
- Sistema di post-combustione

- External facing in majolica
- Panoramic enamelled oven 28 l
- Vitrified cast-iron top frame
- Top cooking plate and rings in polished cast-iron
- Large cast iron hearth
- Post-combustion system

- Revêtement extérieur en faïence
- Four émaillé panoramique de 28 l
- Châssis en fonte vitrifié
- Plaque et cercles en fonte polie
- Large foyer en fonte
- Système de post-combustion
- Flamme Verte: Appareil de class 7★

- Äußere Verkleidung aus Majolika
- Panoramaofen emailliert zu 28 l
- Rahmen aus verglastem Gusseisen
- Platte und Ringe aus geschliffenem Gusseisen
- Breite Feuerstelle aus Gusseisen
- Nachverbrennungssystem

- Revestimiento exterior de mayólica
- Horno panorámico esmaltado de 28 l
- Bastidor de fundición vitrificada
- Plancha y aros de fundición pulida
- Amplio hogar de fundición
- Sistema de post-combustión

## COLORI



Liberty Pergamena Antico

## DATI TECNICI

1030x851x650	Ghisa
183	% 81,1
349x235	2,3
374x290x320	Ø 150 S/P
245x300x384	



## CERTIFICAZIONI

**15a B-VG**

**BImSchV**



## TECNOLOGIA







LIBERTY PERGAMENA ANTICO

# ROSA SINISTRA REVERSE

**A+** | 8,2 kW-N | 235 m<sup>3</sup>

## PLUS

- Rivestimento esterno in maiolica o pietra naturale.
- Forno smaltato panoramico da 28 l
- Telaio in ghisa vetrificata
- Piastra e cerchi in ghisa levigata
- Ampio focolare in ghisa
- Sistema di post-combustione

- External facing in majolica or in natural stone.
- Panoramic enamelled oven 28 l
- Vitrified cast-iron top frame
- Top cooking plate and rings in polished cast-iron
- Large cast iron hearth
- Post-combustion system

- Revêtement extérieur en faïence ou en pierre.
- Four émaillé panoramique de 28 l
- Châssis en fonte vitrifié
- Plaque et cercles en fonte polie
- Large foyer en fonte
- Système de post-combustion
- Flamme Verte: Appareil de class 7★

- Außenverkleidung aus Majolika oder Naturstein.
- Panoramaofen emailliert zu 28 l
- Rahmen aus verglastem Gusseisen
- Platte und Ringe aus geschliffenem Gusseisen
- Breite Feuerstelle aus Gusseisen
- Nachverbrennungsanlage

- Revestimiento externo de mayólica o piedra natural.
- Horno panorámico esmaltado de 28 l
- Bastidor de fundición vitrificada
- Plancha y aros de fundición pulida
- Amplio hogar de fundición
- Sistema de post-combustión

## COLORI











Liberty Bordeaux



Pietra Naturale

## DATI TECNICI

	1030x851x650		Ghisa
	183 mod. BO-PE 200 mod. PT		86,5
	349x235		2,3
	374x290x320		150 S/P
	245x300x384		



## CERTIFICAZIONI

**15a B-VG**

**BImSchV**



## TECNOLOGIA



LIBERTY PERGAMENA ANTICO



# ROSA 4.0

**A+** | 8,4 kW-N | 240 m<sup>3</sup>

## PLUS

- Rivestimento in maiolica o pietra naturale.
  - Focolare interamente in ghisa.
  - Porta fuoco panoramica con vetro ceramico.
  - Forno smaltato panoramico da 41 l.
  - Telaio, piastra e cerchi in ghisa.
  - Cassettone porta legna.
- Außenverkleidung aus Majolika oder Naturstein.
  - Feuerstelle vollständig aus Gusseisen.
  - Panoramafeuertür mit Glaskeramik.
  - Panoramaofen emailliert mit 41 l Inhalt.
  - Rahmen, Platte und Ringe aus Gusseisen.
  - Große Holzschublade.
- Revestimiento externo de mayólica o piedra natural.
  - Hogar completamente de fundición.
  - Puerta fuego panorámica con cristal cerámico.
  - Horno panorámico esmaltado de 41 l.
  - Bastidor, plancha y aros de fundición.
  - Cajón gran para la leña.
- Revêtement extérieur en faïence ou en pierre.
  - Foyer entièrement en fonte.
  - Porte foyer panoramique avec vitre céramique.
  - Four émaillé panoramique de 41 l.
  - Châssis, plaque et cercles en fonte.
  - Tiroir de rangement bois.
  - Flamme Verte: Appareil de class 7★

## COLORI











Liberty Bordeaux



Pietra Naturale

## DATI TECNICI

	1030x851x650		Ghisa
	183 mod. BO-PE 200 mod. PT		87,1
	223x265		2,3
	270x320x362		150 S/P
	330x300x410		



## CERTIFICAZIONI

**15a B-VG**
**BImSchV**

## TECNOLOGIA



# ROSA 4.0 - MAIOLICA

**A+** | 8,4 kW-N | 240 m<sup>3</sup>



## PLUS

- Rivestimento in maiolica.
- Focolare interamente in ghisa.
- Porta fuoco panoramica con vetro ceramico.
- Forno smaltato panoramico da 41 l.
- Telaio, piastra e cerchi in ghisa.
- Cassettone porta legna.

- External facing in majolica.
- Fire-box entirely in cast iron.
- Panoramic fire door with ceramic glass.
- Panoramic enamelled oven 41 l.
- Cast iron frame, plate and rings.
- Wood drawer.

- Revêtement extérieur en faïence
- Foyer entièrement en fonte.
- Porte foyer panoramique avec vitre céramique.
- Four émaillé panoramique de 41 l.
- Châssis, plaque et cercles en fonte.
- Tiroir de rangement bois.
- Flamme Verte: Appareil de class 7★

- Äußere Verkleidung aus Majolika
- Feuerstelle vollständig aus Gusseisen.
- Panoramafeuertür mit Glaskeramik.
- Panoramaofen emailliert mit 41 l Inhalt.
- Rahmen, Platte und Ringe aus Gusseisen.
- Große Holzschublade.

- Revestimiento exterior de mayólica.
- Hogar completamente de fundición.
- Puerta fuego panorámica con cristal cerámico.
- Horno panorámico esmaltado de 41 l.
- Bastidor, plancha y aros de fundición.
- Cajón gran para la leña.

## COLORI



Tortora



Bianco Infinity

## DATI TECNICI

1030x851x650	Ghisa
204	% 87,1
223x265	2,3
270x320x362	Ø 150 S/P
330x300x410	



## CERTIFICAZIONI

**15a B-VG**

**BlmSchV**



## TECNOLOGIA



CUCINE

BORDEAUX



LIBERTY BORDEAUX



# ROSETTA BII

**A+** | 7,2 kW-N | 206 m<sup>3</sup>

## PLUS

- Rivestimento in maiolica o pietra naturale.
  - Focolare interamente in ghisa.
  - Porta fuoco panoramica con vetro ceramico.
  - Forno smaltato panoramico da 28 l.
  - Telaio, piastra e cerchi in ghisa.
  - Cassettone porta legna.
- Verkleidung aus Majolika oder Naturstein.
  - Feuerstelle vollkommen aus Gusseisen.
  - Panoramafeuertür mit Glaskeramik.
  - Panoramaofen emailliert zu 28 l.
  - Rahmen, Platte und Ringe aus Gusseisen.
  - Große Holzschublade.
- Revestimiento de mayólica o piedra natural.
  - Hogar completamente de fundición.
  - Puerta fuego panorámica con cristal cerámico.
  - Horno panorámico esmaltado de 28 l.
  - Bastidor, plancha y aros de fundición.
  - Cajón gran para la leña.
- Revêtement en faïence ou en pierre.
  - Foyer entièrement en fonte.
  - Porte foyer panoramique avec vitre céramique.
  - Four émaillé panoramique de 28 l.
  - Châssis, plaque et cercles en fonte.
  - Tiroir de rangement bois.
  - Flamme Verte: Appareil de class 7★

## COLORI











Liberty Pergamena Antico



Pietra Naturale

## DATI TECNICI

	885x843x572		Ghisa
	153 mod. BO-PE 167 mod. PT		82
	209x265		2,0
	230x270x382		130 S/P
	245x300x384		



## CERTIFICAZIONI

15a B-VG

BlmSchV



## TECNOLOGIA



Kit griglia mobile optional



BORDEAUX

## ROSETTA BII - MAIOLICA

A+ | 7,2 kW-N | 206 m<sup>3</sup>

## PLUS







- Rivestimento in maiolica.
  - Focolare interamente in ghisa.
  - Porta fuoco panoramica con vetro ceramico.
  - Forno smaltato panoramico da 28 l.
  - Telaio, piastra e cerchi in ghisa.
  - Cassettone porta legna.
- Äußere Verkleidung aus Majolika.
  - Feuerstelle vollkommen aus Gusseisen.
  - Panoramafeuertür mit Glaskeramik.
  - Panoramaofen emailliert mit 28 l Inhalt.
  - Rahmen, Platte und Ringe aus gusseisen.
  - Große Holzschublade.
- Revestimiento exterior de mayólica.
  - Hogar completamente de fundición.
  - Puerta fuego panorámica con cristal cerámico.
  - Horno panorámico esmaltado de 28 l.
  - Bastidor, plancha y aros de fundición.
  - Cajón gran para la leña.
- Revêtement extérieur en faïence.
  - Foyer entièrement en fonte.
  - Porte foyer panoramique avec vitre céramique.
  - Four émaillé panoramique de 28 l.
  - Châssis, plaque et cercles en fonte.
  - Tiroir de rangement bois.
  - Flamme Verte: Appareil de class 7★

## COLORI



Tortora

## DATI TECNICI

	885x843x572		Ghisa
	169	%	82
	209x265		2
	230x270x382	∅	130 S/P
	245x300x384		



## CERTIFICAZIONI

15a B-VG

BlmSchV



 Flamme  
 VERTE

 HETAS

## TECNOLOGIA

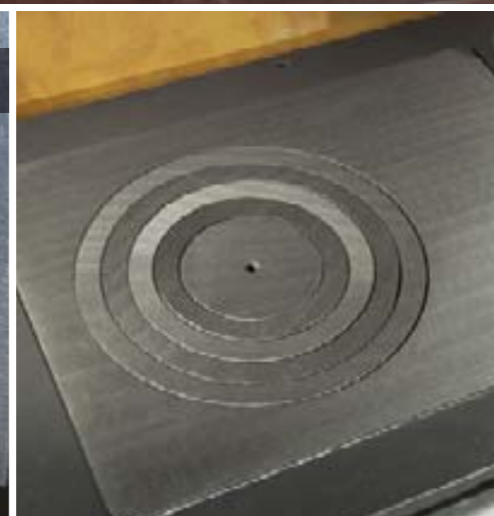

Kit griglia mobile optional



# ROSETTA SINISTRA BII

**A** | 7,3 kW-N | 209 m<sup>3</sup>



## PLUS

- Rivestimento esterno in maiolica o pietra naturale.
- Focolare interamente in ghisa.
- Porta fuoco panoramica con vetro ceramico.
- Forno smaltato panoramico da 28 l.
- Telaio, piastra e cerchi in ghisa.
- Cassettoni porta legna.
- Porte in ghisa vetrificata.

- External facing in majolica or in natural stone.
- Fire-box entirely in cast iron.
- Panoramic fire door with ceramic glass.
- Panoramic enameled oven 28 l.
- Cast iron frame, plate and rings.
- Wood drawer.
- Vitrified cast-iron top frame door.

- Revêtement extérieur en faïence ou en pierre.
- Foyer entièrement en fonte.
- Porte foyer panoramique avec vitre céramique.
- Four émaillé panoramique de 28 l.
- Châssis, plaque et cercles en fonte.
- Tiroir de rangement bois.
- Portes en fonte vitrifiée.
- Flamme Verte: Appareil de class 7★

- Außenverkleidung aus Majolika oder Naturstein.
- Feuerstelle vollkommen aus Gusseisen.
- Panoramafeuertür mit Glaskeramik.
- Panoramaofen emailliert zu 28 l.
- Rahmen, Platte und Ringe aus Gusseisen.
- Große Holzschublade.
- Türen aus verglastem Gusseisen.

- Revestimiento externo de mayólica o piedra natural.
- Hogar completamente de fundición.
- Puerta fuego panorámica con cristal cerámico.
- Horno panorámico esmaltado de 28 l.
- Bastidor, plancha y aros de fundición.
- Cajón grande para la leña.
- Puertas de fundición esmaltada.

## COLORI



Liberty Pergamena Antico



Pietra Naturale

## DATI TECNICI

885x843x572	Ghisa
153 mod. BO-PE 167 mod. PT	% 80
209x265	2,0
230x270x382	∅ 130 S/P
245x300x384	



## CERTIFICAZIONI

**15a B-VG**

**BImSchV**



## TECNOLOGIA



CUCINE



LIBERTY BORDEAUX



# FAMILY 4,5

**A+** | 7,5 kW-N | 215 m<sup>3</sup>**PLUS**

- Rivestimento esterno in acciaio porcellanato
  - Porta fuoco panoramica con doppio vetro
  - Forno smaltato da 41 litri con porta a doppio vetro
  - Telaio in ghisa vetrificata
  - Centri e cerchi in ghisa levigata
  - Focolare in ghisa G20
  - Cassettoni porta-legna
  - Piedini per agevolare pulizia
  - Coperchio optional.
- Außenverkleidung aus porzellan-emailliertem Stahl
  - Panoramafeuertür mit Doppelverglasung
  - 41 Liter emaillierter Ofen mit doppelt verglaster Tür
  - Toprahmen aus porzellan-emailliertem Gusseisen
  - Kochfläche und Ringe aus geschliffenem Gusseisen
  - Brennraum aus Gusseisen G20
  - Optionale Abdeckplatte.
- Revestimiento exterior en acero esmaltado
  - Puerta del hogar panorámica con doble cristal
  - Horno esmaltado de 41 litros con doble cristal
  - Bastidor en hierro fundido vitrificado
  - Encimera con aros en hierro fundido pulido
  - Hogar en hierro fundido G20
  - Tapa opcional.
- Enamelled external steel coating
  - Panoramic fire door with double glass
  - 41 liter Enamelled oven with double glass door
  - Vitrified cast-iron frame
  - Top with polished cast-iron circles
  - G20 cast-iron hearth
  - Optional cover.
- Revêtement externe en fonte émaillée
  - Porte anti-incendie panoramique avec verre double
  - Four émaillé de 41 litres avec porte vitrée double
  - Cadre en fonte vitrifiée (très solide)
  - Plaque de cuisson avec cercles de fonte polie (très solides)
  - Foyer en fonte G20 (très solide)
  - Couvercle optionnel.
  - Flamme Verte: Appareil de class 7★









**COLORI**

Bianco



Cappuccino

**OPTIONAL****DATI TECNICI**

 964x853x642	 Ghisa
 125	 81
 217x190	 2,2
 220x220x400	 130 S
 330x300x410	

**CERTIFICAZIONI****15a B-VG****BlmSchV****TECNOLOGIA**

NERO ANTRACITE

# FAMILY 3,5

**A+** | 6,5 kW-N | 186 m³



## PLUS

- Rivestimento esterno in acciaio porcellanato
- Forno smaltato da 28 litri con porta a doppio vetro
- Porta fuoco panoramica con doppio vetro
- Telaio in ghisa vetrificata
- Centrino e cerchi in ghisa levigata
- Focolare in ghisa G20
- Cassettone porta-legna
- Piedini per agevolare pulizia
- Coperchio optional.

- Enamelled external steel coating
- Panoramic fire door with double glass
- 28 liter Enamelled oven with double glass door
- Vitrified cast-iron frame
- Top with polished cast-iron circles
- G20 cast-iron hearth
- Wood drawer
- Feet for easy cleaning
- Optional cover.

- Revêtement externe en fonte émaillé
- Porte anti-incendie panoramique avec double verre
- Four émaillé de 28 litres avec porte vitrée doubl
- Cadre en fonte vitrifié (très solide)
- Plaque de cuisson avec cercles de fonte polie (très solides)
- Foyer en fonte G20 (très solide)
- Bac pour le bois
- Pieds pour faciliter le nettoyage
- Couvre-ciel optionnel.
- Flamme Verte: Appareil de class 7★

- Außenverkleidung aus porzellan-emailliertem Stahl
- Panoramafeuertür mit Doppelverglasung
- 28 Liter emaillierter Ofen mit doppelt verglaster Tür
- Toprahmen aus porzellan-emailliertem Gusseisen
- Kochfläche und Ringe aus geschliffenem Gusseisen
- Brennraum aus Gusseisen G20
- Große Holzschublade
- Füße um die Reinigung zu erleichtern
- Optionale Abdeckplatte.

- Revestimiento exterior de acero esmaltado
- Puerta del hogar panorámica con doble cristal
- Horno esmaltado de 28 litros con doble cristal
- Bastidor en hierro fundido vitrificado
- Encimera con aros en hierro fundido pulido
- Hogar de hierro fundido G20
- Cajón para leña
- Patas para facilitar limpieza
- Tapa opcional.

## COLORI

## OPTIONAL



Nero antracite



Bianco



## DATI TECNICI

881x845x581	Ghisa
110	% 83
213x187	1,9
220x227x360	Ø 120 S
245x300x384	



## CERTIFICAZIONI

15a B-VG

BImSchV



## TECNOLOGIA



CAPPUCCINO



# SOVRANA EVO 2.0

**A+** | 7,5 kW-N | 215 m<sup>3</sup>

## PLUS

- Rivestimento esterno in acciaio porcellanato.
  - Fianchi a convezione termica.
  - Forno smaltato con doppio vetro da 41 l.
  - Cassetto scaldavivande.
  - Telaio, piastra e cerchi in ghisa.
  - Facciata e focolare in ghisa.
  - Cassettone porta legna.
  - Telaio in ghisa vetrificata.
  - Coperchio di serie.
- Außenverkleidung aus porzellan-emailliertem Stahl.
  - Seiten mit Wärmekonvektion.
  - Emaillierter Ofen mit Doppelglas mit 41 l Inhalt.
  - Behälter zum Warmhalten von Lebensmitteln.
  - Rahmen, Platte und Ringe aus Gusseisen.
  - Ansichtsseite und Feuerstelle aus Gusseisen.
  - Große Holzschublade.
  - Rahmen aus verglastem Gusseisen.
  - Serienmäßige Abdeckung.
- Revestimiento externo de acero esmaltado.
  - Laterales de convección térmica.
  - Horno esmaltado con cristal doble de 41 l.
  - Cajón calentaplatos.
  - Bastidor, plancha y aros de fundición.
  - Frontal y hogar de fundición.
  - Cajón gran para la leña.
  - Bastidor de fundición vitrificada.
  - Tapa de serie.
- Enamelled external facing.
  - Thermal convection flanks.
  - Enamelled oven with double glass 41 l.
  - Warming drawer.
  - Cast iron frame, plate and rings.
  - Cast iron facade and hearth.
  - Wood drawer.
  - Vitrified cast-iron top frame.
  - Cover as standard.
- Revêtement extérieur en acier émaillé.
  - Côtés à convection thermique.
  - Four émaillé avec double vitre de 41 l.
  - Tiroir pour réchauffer les aliments.
  - Châssis, plaque et cercles en fonte.
  - Façade et foyer en fonte.
  - Tiroir de rangement bois.
  - Châssis en fonte vitrifiée.
  - Couvercle en série.
  - Flamme Verte: Appareil de class 7★

NERO ANTRACITE









## COLORI



Cappuccino

Bianco

## DATI TECNICI

 964x848x641	 Ghisa
 143	 81
 217x190	 2,2
 220x220x400	 130 S/P
 330x300x410	



## CERTIFICAZIONI

15a B-VG

BlmSchV

flamme  
VERTE

HETAS

## TECNOLOGIA





NERO ANTRACITE

# SOVRANA EASY EVO

**A** | 9,0 kW-N | 258 m<sup>3</sup>**PLUS**

- Rivestimento esterno in acciaio porcellanato.
  - Focolare in ghisa con sistema di post combustione.
  - Griglia fuoco in ghisa.
  - Porta fuoco con doppio vetro.
  - Forno smaltato panoramico da 41 l.
  - Telaio, piastra e cerchi in ghisa.
  - Cassetto porta legna.
  - Coperchio optional.
- Außenverkleidung aus porzellan-emailliertem Stahl.
  - Feuerraumverkleidung aus Gusseisen mit Doppelverbrennung.
  - Feuerrost aus Gusseisen.
  - Feuertür mit Doppelglas.
  - Panoramaofen emailliert mit 41 l Inhalt.
  - Rahmen, Platte und Ringe aus Gusseisen.
  - Holzschublade.
  - Optionale Abdeckplatte.
- Revestimiento externo de acero esmaltado.
  - Hogar en fundición con sistema de post combustión.
  - Rejilla de fuego de fundición.
  - Puerta con cristal doble.
  - Horno panorámico esmaltado de 41 l.
  - Bastidor, plancha y aros de fundición.
  - Cajón para la leña.
  - Tapa opcional.
- Enamelled external facing.
  - Hearth in cast iron with post combustion system.
  - Cast iron fire grate.
  - Double glass fire door.
  - Panoramic enamelled oven 41 l.
  - Cast iron frame, plate and rings
  - Wood drawer.
  - Optional cover.
- Revêtement extérieur en acier émaillé.
  - Foyer en fonte avec système post combustion.
  - Grille foyer en fonte.
  - Porte foyer avec double vitre.
  - Four émaillé panoramique de 41 l.
  - Châssis, plaque et cercles en fonte.
  - Tiroir de rangement bois.
  - Couvercle optionnel.

**COLORI**

Cappuccino



Bianco

**OPTIONAL****DATI TECNICI**

964x848x641	Ghisa
140	% 76
217x190	2,8
220x220x400	Ø 130 S/P
330x300x410	

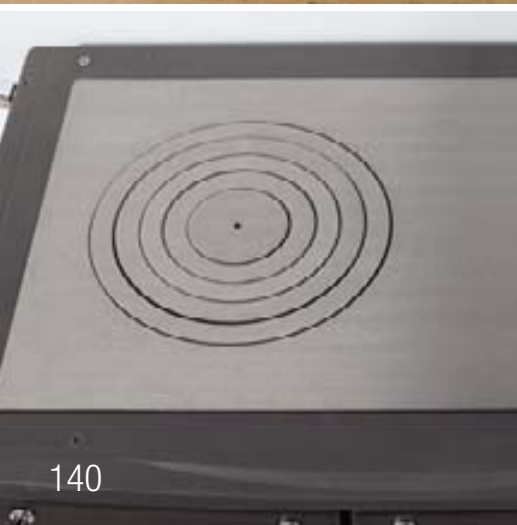
**CERTIFICAZIONI****15a B-VG****BlmSchV****TECNOLOGIA**

# ROMANTICA 3,5

**A** | 5,0 kW-N | 143 m<sup>3</sup>

## PLUS

- Rivestimento esterno in acciaio porcellanato.
- Focolare interamente in ghisa.
- Forno smaltato con doppio vetro da 28 l (Romantica 3,5 da 22 l).
- Telaio in ghisa vetrificata.
- Piastra e cerchi in ghisa levigata.
- Coperchio di serie

- Enamelled external facing.
- Fire-box entirely in cast iron.
- Enamelled oven with double glass 28 l (Romantica 3,5 22 l).
- Vitrified cast-iron top frame.
- Top cooking plate and rings in polished cast-iron.
- Cover as standard.

- Revêtement extérieur en acier émaillé.
- Foyer entièrement en fonte.
- Four émaillé avec double vitre de 28 l (Romantica 3,5 de 22 l).
- Châssis en fonte vitrifiée.
- Plaque et cercles en fonte polie.
- Couvercle en série.

# ROMANTICA 4,5

**B** | 6,0 kW-N | 172 m<sup>3</sup>

- Außenverkleidung aus porzellan-emailliertem Stahl.
- Feuerstelle vollkommen aus Gusseisen.
- Emailierter Ofen mit Doppelglas mit 28 l Inhalt (Romantica 3,5 mit 22 l Inhalt).
- Rahmen aus verglastem Gusseisen.
- Platte und Ringe aus geschliffenem Gusseisen.
- Serienmäßige Abdeckung.

- Revestimiento externo de acero esmaltado.
- Hogar completamente de fundición.
- Horno esmaltado con cristal doble de 28 l (Romantica 3,5 de 22 l).
- Bastidor de fundición vitrificada.
- Plancha y aros de fundición pulida.
- Tapa de serie.

## COLORI



Nero Antracite

Bianco

Cappuccino

Marrone Sfumato

## DATI TECNICI ROMANTICA 3,5



↓ 887x856x568	▒ Ghisa
⚖ 79	% 76
📏 150x140	🕒 1,4
📏 190x150x340	⌀ 120 S
📏 258x232x368	

## DATI TECNICI ROMANTICA 4,5



↓ 968x860x620	▒ Ghisa
⚖ 90	% 66
📏 190x170	🕒 1,8
📏 190x180x375	⌀ 130 S
📏 300x230x405	



RUSTIC  
(No Romantica 3,5)

CUCINE



Kit vasca inox optional



# CAMINETTI

Wood fireplaces  
Cheminées à Bois  
Scheitholz Kamine  
Chimeneas de leña



## INSERTI

Wood burning inserts - Inserts à bois  
Holz befeuerte Kassetten - Insertables de leña

### INSERTO GHISA

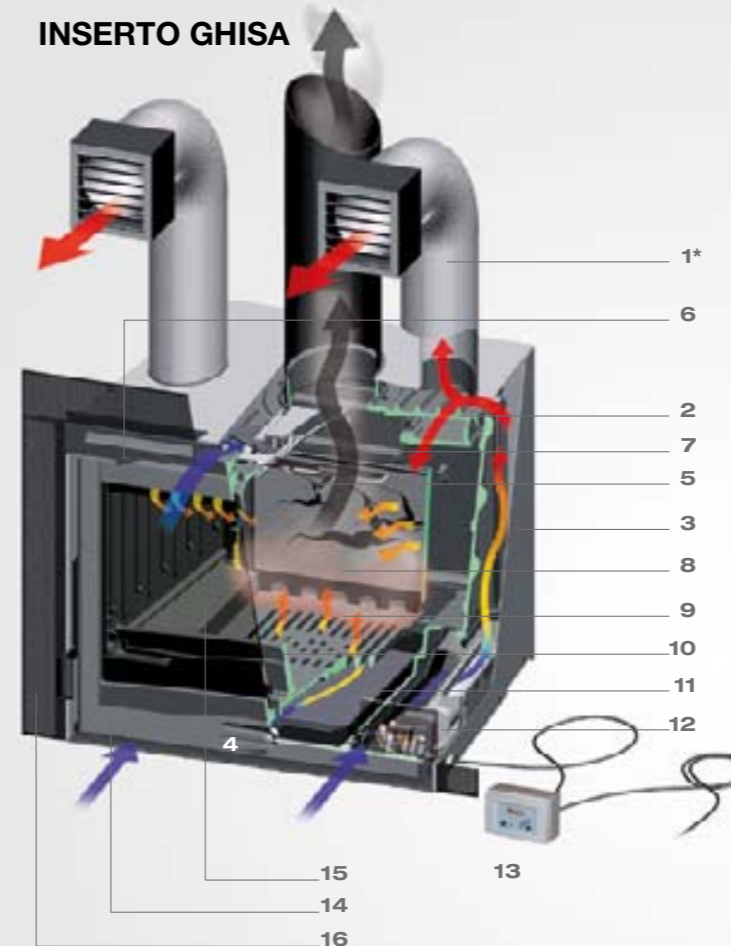

### INSERTO CRYSTAL

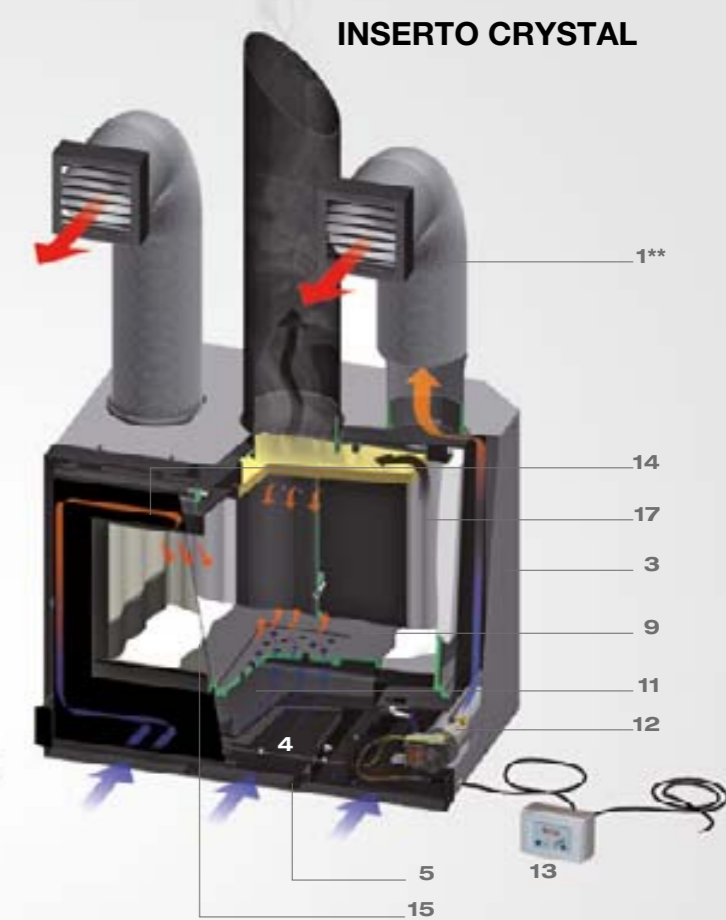

- 1 N. 2 uscite aria calda Ø 120\*-150\*\* mm. • No. 2 hot air outlets Ø 120\*-150\*\* • Nr. 2 sorties air chaude Ø 120\*-150\*\* • N. 2 Warmluftauslässe Ø 120\*-150\*\* • Núm. 2 salidas aire caliente Ø 120\*-150\*\*
- 2 Struttura interamente in ghisa • Structure completely in cast-iron • Structure entièrement en fonte • Struktur komplett aus Gusseisen • Estructura enteramente en fundición.
- 3 Carter di ventilazione in acciaio • Ventilation covering in steel • Revêtement de ventilation en acier • Lüftungsverkleidung aus Stahl • Cáster de ventilación en acero.
- 4 Aria primaria regolabile • Adjustable primary air • Air primaire réglable • Einstellbare Primärluft • Aire primario regulable.
- 5 Aria secondaria regolabile • Adjustable secondary air • Air secondaire réglable • Einstellbare Sekundärluft • Aire secundario regulable.  
Regolazione valvola con riposizionamento automatico • Valve adjustment with automatic return • Réglage vanne avec retour automatique • Ventilreglegung mit automatischer Rücklauf
- 6 Regolazione válvula con recolocación automática.
- 7 Deflettore e valvola fumi in ghisa • Smoke deflector and valve in cast-iron • Déflecteur et vanne fumées en fonte • Rauchumlenkung und Rauchventil aus Gusseisen • Deflector y válvula de humos en fundición.
- 8 Schiena in ghisa girevole con due decori diversi • Cast-iron revolving back with 2 different decorations • Dos tournant en fonte avec deux différentes décorations • Umkehrbare, gusseiserne Rückseite mit 2 verschiedenen Dekoren • Respaldo en fundición rotativo con dos decoraciones distintas.
- 9 Braciere e griglia estraibile in ghisa • Brazier and extractable grate in cast-iron • Brasero et grille extractible en fonte • Brennschale und ausziehbarer Rost aus Gusseisen • Braseiro y rejilla extraíble en fundición.
- 10 Paraceppo in ghisa estraibile • Cast iron extractable glass protection • Protection vitre extractible en fonte • Ausziehbarer Stehrost aus Gusseisen • Guardacón en fundición extraíble.
- 11 Cassetto cenere estraibile • Extractable ash drawer • Tiroir cendrier extractible en fonte • Ausziehbarer Aschenkasten • Cenicero extraíble.
- 12 N. 2 Ventilatori tangenziali con termostato • No.2 tangential fans with thermostat • N. 2 ventilateurs tangentiels avec thermostat • N.2 tangential Lüfter mit Thermostat • Núm. 2 Ventiladores tangenciales con termostato.
- 13 Centralina elettronica digitale regolabile per il controllo dei ventilatori • Adjustable electronic digital control unit for the fans control • Unité de contrôle digital électronique pour le contrôle des ventilateurs • Digitale elektronische Steuereinheit zur Kontrolle der Lüfter • Unidad de conducción digital electrónica regulable para el control de los ventiladores.
- 14 Porta in ghisa con possibilità autonoma di cambiare apertura dx o sx (solo Inserti Crystal) • Cast-iron door with possibility to change by yourself the door opening direction from right to left (only Crystal inserts) • Porte en fonte avec possibilité autonome de changer l'ouverture vers droite ou vers gauche (inserts Crystal uniquement) • Gusseiserne Tür mit Möglichkeit, selbstständig die Öffnungsrichtung der Tür nach rechts oder nach links zu ändern (nur Crystal-Einsätze) • Puerta en fundición con posibilidad autónoma de mudar la abertura derecha o izquierda (solo empotrables Crystal).
- 15 Vetro ceramico resistente fino a 750° • Ceramic glass resistant up to 750°C • Vitre céramique résistant jusqu'à 750° • Keramikglas, beständig bis 750°C • Cristal cerámico que resiste hasta 750°C.
- 16 Kit cornici di compensazione (optional) • Adaptation frames kit (optional) • Kit cadres d'adaptation (Optionnel) • Kit Anpassungsrahmen (optional) • Kit marcos compensadores (opcional).
- 17 Focolare in Ghisa/Nordiker • Hearth in Cast-iron/Nordiker • Foyer en Fonte/Nordiker • Feuerstelle aus Gusseisen/Nordiker • Hogar en Fundición/Nordiker.

N.B.: Per il corretto funzionamento dell'apparecchio devono essere predisposte durante il montaggio due griglie di areazione di dimensione adeguata, una inferiore di ingresso ed una superiore di uscita, per consentire la diffusione del calore nell'ambiente ed il giusto raffreddamento del prodotto (vedi manuale allegato al prodotto) / N.B.: Two adequately sized ventilation grilles (an inlet grille at the bottom and an outlet one at the top) should be installed during assembly to ensure correct operation and permit heating of the room and correct cooling of the product (see the manual attached to the product) / N.B.: Pour le bon fonctionnement de l'appareil, deux grilles d'aération de la bonne dimension doivent être prédisposées pendant le montage, une inférieure d'entrée et une supérieure de sortie, afin de permettre la diffusion de la chaleur dans la pièce et un refroidissement correct du produit (voir le manuel joint au produit) / N.B.: Für den einwandfreien Betrieb des Geräts müssen bei der Montage zwei Belüftungsgitter geeigneter Größe vorgesehen werden, eines unten für den Einlass und eines oben für den Auslass. Dadurch werden die Ausbreitung der Wärme im Raum und die angemessene Kühlung des Ofens sichergestellt (siehe beiliegende Ofenanleitung) / NOTA: Para que el aparato funcione correctamente, durante el montaje se deben incluir dos rejillas de ventilación de dimensiones adecuadas, una inferior de entrada y una superior de salida, para permitir la difusión del calor en el ambiente y el correcto enfriamiento del producto (consulte el manual entregado con el producto).

# FOCOLARI

Hearth / Foyer / Feuerstellen / Hogares

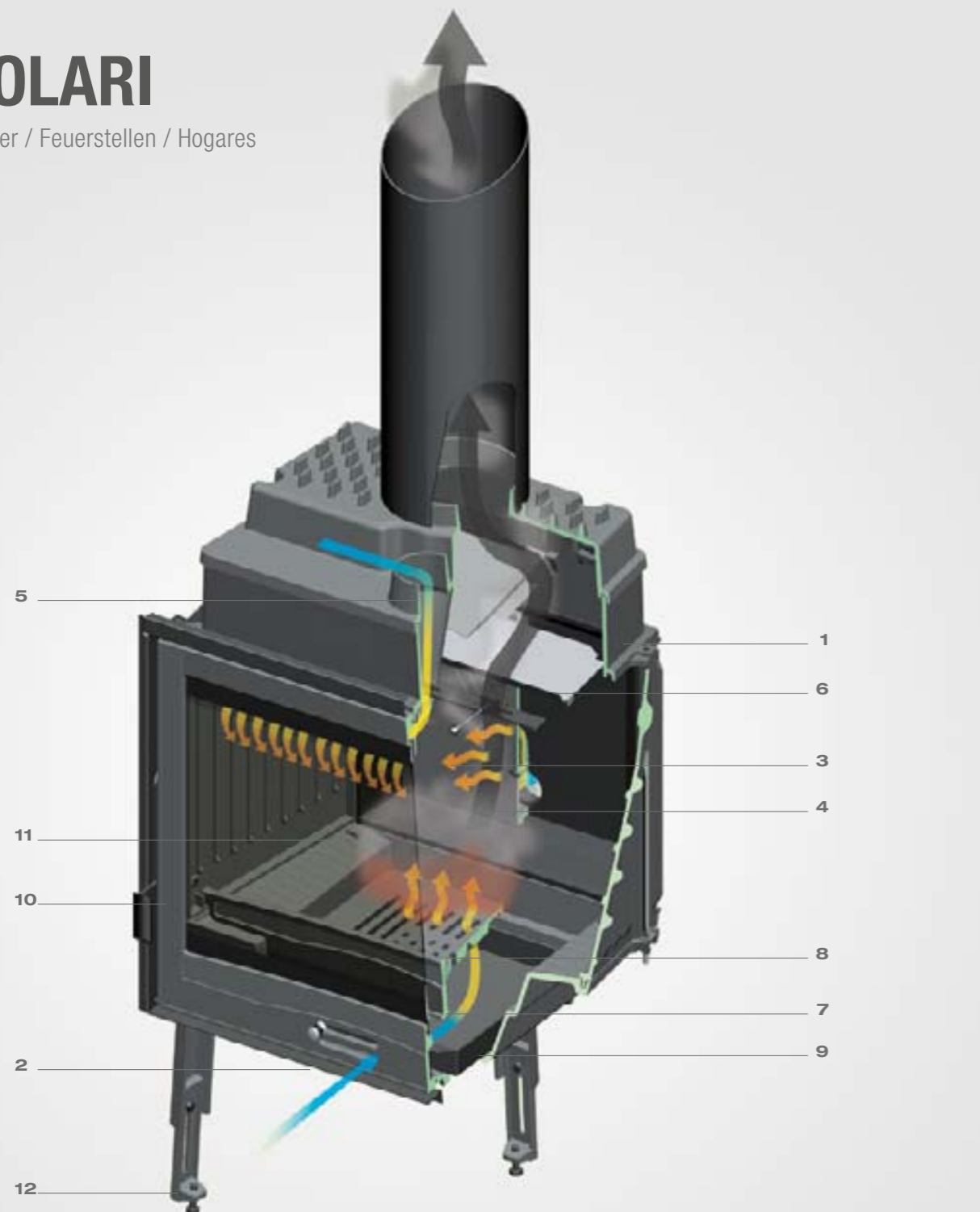

- 1 Struttura interamente in ghisa • Structure entirely made of cast iron • Structure entièrement en fonte • Struktur komplett aus Gusseisen • Estructura enteramente en fundición.
- 2 Aria primaria regolabile • Adjustable primary air • Air primaire réglable • Einstellbare Primärluft • Aire primario regulable.
- 3 Aria secondaria regolabile • Adjustable secondary air • Air secondaire réglable • Einstellbare Sekundärluft • Aire secundario regulable.
- 4 Aria terziaria prearata • Pre-calibrated tertiary air • Air tertiaire pre-tarée • Vorgeeichte Tertiärluft • Aire terciario precalibrado.
- 5 Presa aria secondaria comburente canalizzabile • Secondary combustion air intake duct • Pris d'air secondaire canalisable pour la combustion • Kanalisierbarer verbrennungsfördernder Lufteinlass • Toma de aire secundario comburente encauzable.
- 6 Doppio deflettore • Double deflector • Double déflecteur • Doppelrauchumlenkung • Doble deflector.
- 7 Paraceppo in ghisa estraibile • Removable cast iron stump guard • Protection vitre extractible • Ausziehbarer Stehrost aus Gusseisen • Guardatocón en fundición extraíble.
- 8 Braciere e griglia estraibile in ghisa • Removable cast iron brazier and grid • Brasero et grille extractible en fonte • Brennschale und ausziehbarer Rost aus Gusseisen • Brasero y rejilla extraíble en fundición.
- 9 Cassetto porta cenere estraibile • Extractable ash holder drawer • Tiroir cendrier extractible • Ausziehbarer Aschenkasten • Cenicero extraíble.
- 10 Porta in ghisa • Cast iron door • Porte en fonte • Tür aus Gusseisen • Puerta en fundición
- 11 Vetro ceramico serigrafato resistente fino a 750°C • Ceramic glass screenprinted resistant up to 750°C • Vitre céramique avec dessin en sérigraphie résistant jusqu'à 750°C • Siebgedrucktes Keramikglas, beständig bis 750°C • Cristal cerámico serigrafado que resiste hasta 750°C.
- 12 Piedini regolabili in ghisa • Adjustable cast iron feet • Pieds réglables en fonte • Gusseiserne, einstellbare Füße • Pies regulables en fundición.

N.B.: Per il corretto funzionamento dell'apparecchio devono essere predisposte durante il montaggio due griglie di areazione di dimensione adeguata, una inferiore di ingresso ed una superiore di uscita, per consentire la diffusione del calore nell'ambiente ed il giusto raffreddamento del prodotto (vedi manuale allegato al prodotto) / N.B.: Two adequately sized ventilation grilles (an inlet grille at the bottom and an outlet one at the top) should be installed during assembly to ensure correct operation and permit heating of the room and correct cooling of the product (see the manual attached to the product) / N.B.: Pour le bon fonctionnement de l'appareil, deux grilles d'aération de la bonne dimension doivent être prédisposées pendant le montage, une inférieure d'entrée et une supérieure de sortie, afin de permettre la diffusion de la chaleur dans la pièce et un refroidissement correct du produit (voir le manuel joint au produit) / N.B.: Für den einwandfreien Betrieb des Geräts müssen bei der Montage zwei Belüftungsgitter geeigneter Größe vorgesehen werden, eines unten für den Einlass und eines oben für den Auslass. Dadurch werden die Ausbreitung der Wärme im Raum und die angemessene Kühlung des Ofens sichergestellt (siehe beiliegende Ofenanleitung) / NOTA: Para que el aparato funcione correctamente, durante el montaje se deben incluir dos rejillas de ventilación de dimensiones adecuadas, una inferior de entrada y una superior de salida, para permitir la difusión del calor en el ambiente y el correcto enfriamiento del producto (consulte el manual entregado con el producto).

# MONOBLOCCHI

Monoblocks / Monoblocs  
Monoblöcke / Monobloque

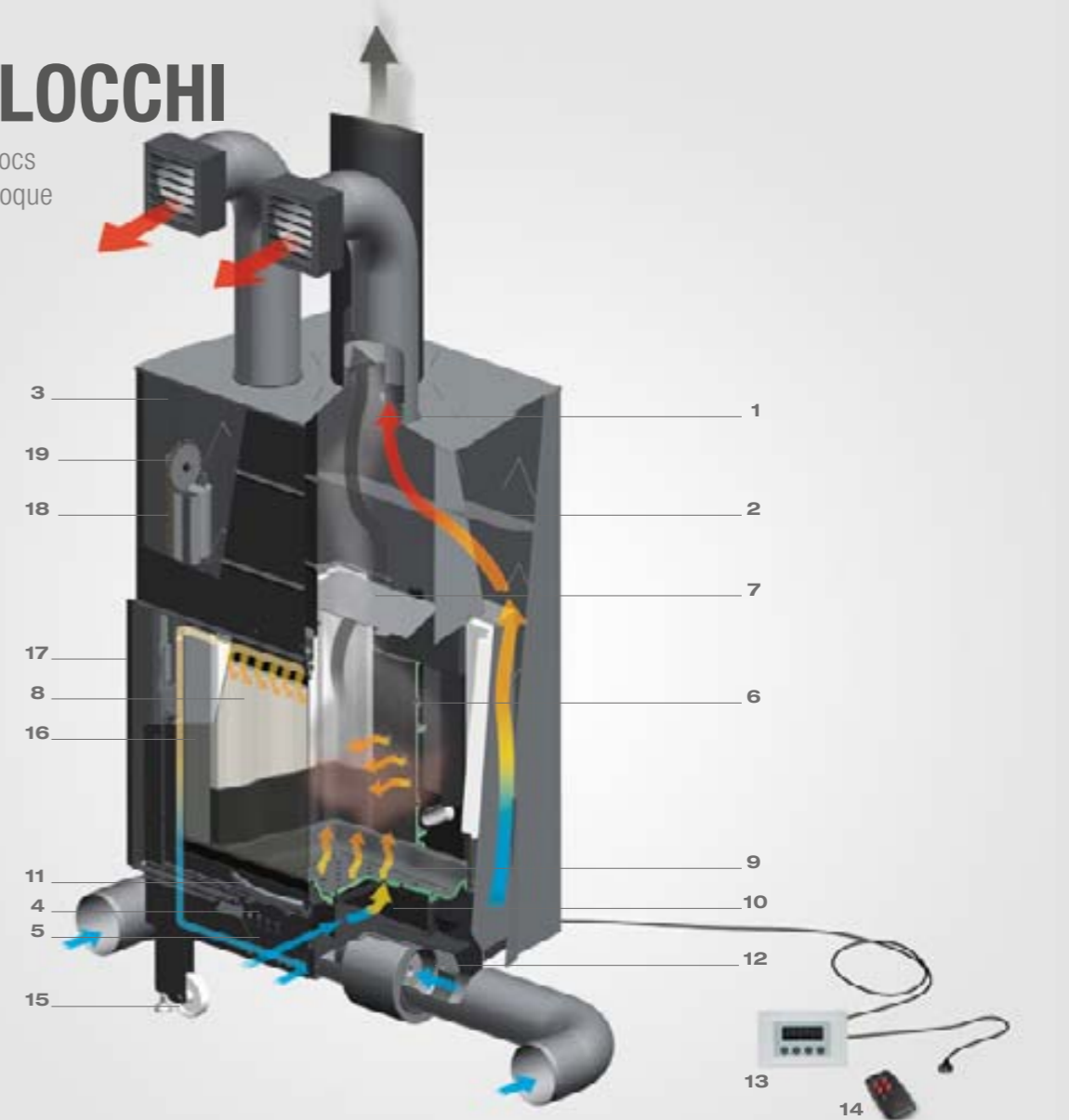

- 1 N. 4 uscite aria calda Ø 150 mm • 4 hot air outputs Ø 150 mm • Nr.4 sorties air chaude Ø 150 mm • N.4 Warmluftauslässe Ø 150 mm • Núm. 4 salidas aire caliente Ø 150 mm.
- 2 Parte superiore in ghisa • Cast iron top • Partie supérieure en fonte • Oberer Teil aus Gusseisen • Lado superior en fundición.
- 3 Carter di protezione • Protection covering • Revêtement de protection • Protection covering • Schutzverkleidung • Carter de protección.
- 4 Aria primaria regolabile • Adjustable primary air • Air primaire réglable • Einstellbare Primärluft • Aire primario regulable.
- 5 Aria secondaria regolabile • Adjustable secondary air • Air secondaire réglable • Einstellbare Sekundärluft • Aire secundario regulable.
- 6 Aria terziaria prearata su schiena in ghisa • Pre-calibrated tertiary air on the cast iron back • Air tertiaire pre-tarée sur le dos en fonte • Vorgeeichte Tertiärluft auf der gusseisernen Rückseite • Aire terciario precalibrado en el respaldo en fundición.
- 7 Doppio deflettore estraibile • Removable double deflector • Double déflecteur extractible • Ausziehbarer Doppelrauchumlenkung • Doble deflector extraíble.
- 8 Focolare in Nordiker • Nordiker fireplace • Foyer en Nordiker • Feuerstelle aus Nordiker • Hogar en Nordiker.
- 9 Braciere e griglia in ghisa estraibili • Removable cast iron grid and brazier • Brasero et grille extractibles en fonte • Ausziehbarer Brennschale und ausziehbarer Rost aus Gusseisen • Brasero y rejilla extraíble en fundición.
- 10 Cassetto porta cenere estraibile • Extractable ash holder drawer • Tiroir cendrier extractible en fonte • Ausziehbarer Aschenkasten • Cenicero extraíble.
- 11 Maniglia in acciaio • Handle of steel • Poignée en acier • Griff aus Stahl • Manilla en acero.
- 12 Ventilatore centrifugo portata aria 800 m3/ora (optional) • Centrifugal fan air flow 800 m3/hr (optional) • Ventilateur centrifugeur avec portée air 800 m3/heure (Optionnel) • Zentrifugallüfter mit Leistung 800 m3/Stunde (Optional) • Turbina centrifuga con rendimiento de aire 800 m3/ hora (opcional).
- 13 Regolatore elettronico digitale per il controllo del ventilatore completa di sonda (Optional) • Electronic digital regulator to control the fan complete with probe (Optional) • Unité de contrôle électronique complet de sonde pour le contrôle du ventilateur (Optionnel) • Elektronische Steuereinheit mit Wärmefühler für die Steuerung des Lüfters (Optional) • Unidad de conducción electrónica para el control del ventilador equipada de sonda (Opcional).
- 14 Telecomando centralina (Optional) • Control unit remote control (Optional) • Télécommande unité de contrôle (Optionnel) • Fernbedienung der Steuereinheit (Optional) • Telemando unidad de conducción (Opcional).
- 15 Piedini regolabili in altezza / ruote per il posizionamento • Height adjustable feet / wheels for positioning • Hauteur réglable de pieds / roues pour le positionnement • Einstellbare Höhe der Füße / Räder für die Positionierung • Pies regulables en altura / ruedas de colocación.
- 16 Porta saliscendi con vetro ceramico serigrafato • Vertical sliding door with screenprinted ceramic glass • Porte loquet avec vitre céramique sérigraphée • Vertikal schließende Tür mit siebgedrucktem Keramikglas • Puerta corrediza que se cierra verticalmente con cristal cerámico serigrafado.
- 17 Guide di scorrimento a sfera silenziate • Silenced sliding ball guides • Glissières télescopiques à billes silencieux • Teleskopführungen aus geräuschgedämpften Kugeln • Guías de deslizamiento de bolas silenciosas.
- 18 Catena p. kg. 800 • Chain capacity Kg 800 • Chaîne portée Kg 800 • Kette Tragweite kg 800 • Cadena p. 800 kg.
- 19 Corona dentata • Toothed crown • Pignon • Zahnkranz • Corona dentada.

N.B.: Per il corretto funzionamento dell'apparecchio devono essere predisposte durante il montaggio due griglie di areazione di dimensione adeguata, una inferiore di ingresso ed una superiore di uscita, per consentire la diffusione del calore nell'ambiente ed il giusto raffreddamento del prodotto (vedi manuale allegato al prodotto) / N.B.: Two adequately sized ventilation grilles (an inlet grille at the bottom and an outlet one at the top) should be installed during assembly to ensure correct operation and permit heating of the room and correct cooling of the product (see the manual attached to the product) / N.B.: Pour le bon fonctionnement de l'appareil, deux grilles d'aération de la bonne dimension doivent être prédisposées pendant le montage, une inférieure d'entrée et une supérieure de sortie, afin de permettre la diffusion de la chaleur dans la pièce et un refroidissement correct du produit (voir le manuel joint au produit) / N.B.: Für den einwandfreien Betrieb des Geräts müssen bei der Montage zwei Belüftungsgitter geeigneter Größe vorgesehen werden, eines unten für den Einlass und eines oben für den Auslass. Dadurch werden die Ausbreitung der Wärme im Raum und die angemessene Kühlung des Ofens sichergestellt (siehe beiliegende Ofenanleitung) / NOTA: Para que el aparato funcione correctamente, durante el montaje se deben incluir dos rejillas de ventilación de dimensiones adecuadas, una inferior de entrada y una superior de salida, para permitir la difusión del calor en el ambiente y el correcto enfriamiento del producto (consulte el manual entregado con el producto).



Aria primaria / Primary air / Air primaire / Primärluft / Aire primario



Elemento rastremato per facilitare l'installazione  
Shaped Element for an easy installation  
Élément façonné pour une installation facile  
Geformter Teil für eine einfache Installation  
Elemento ahusado para facilitar su instalación



Aria primaria / Primary air / Air primaire / Primärluft / Aire primario



Focolare in ghisa-vermiculite  
Cast iron-vermiculite hearth  
Foyer en fonte-vermiculite  
Feuerraum aus Gusseisen-Vermiculit  
Hogar en fundición-vermiculita

## INSERTO 60 - VENTILATO

**A+** | 7,0 kW-N | 200 m<sup>3</sup>



### PLUS

- Cassetto cenere estraibile
- Ghisa da 8 e 16 mm
- Vetro ceramico resistente fino a 750°
- Porta in ghisa
- Aria primaria e secondaria regolabile
- Ventilatori tangenziali di serie

- Extractable ash drawer
- Cast iron of 8 and 16mm
- Ceramic glass heat-resistant 750°C
- Door in cast iron
- Adjustable primary and secondary air
- Standard tangential fans







- Tiroir pour cendres extractible
- Fonte de 8 à 16 mm
- Vitre céramique résistant jusqu'à 750°
- Porte en fonte
- Air primaire et secondaire réglables
- Ventilateurs tangentiels de série

- Ausziehbarer Aschenbehälter
- Gusseisen, Stärke 8 und 16 mm
- Glaskeramikfenster, hitzebeständig bis auf 750°
- Tür aus Gusseisen
- Verstellbare Primär und Sekundärluft
- Serienmäßige Tangentialventilatoren

- Cenicero extraíble
- Hierro fundido de 8 y 16 mm
- Cristal cerámico resistente hasta 750°C
- Puerta de hierro fundido
- Aire primaria y secundaria regulable
- Ventiladores tangenciales de serie

### DATI TECNICI



 595x500x440	 Ghisa
 115	% 81,3
 465x250	 2,0
 420x280x300	∅ 160

### TECNOLOGIA



## INSERTO 60 4.0 - VENTILATO

**A+** | 6,5 kW-N | 186 m<sup>3</sup>



### PLUS

- Cassetto cenere estraibile
- Focolare in ghisa-vermiculite
- Vetro ceramico resistente fino a 750° C
- Porta in ghisa
- Aria primaria e secondaria regolabile, aria terziaria pretrata con sistema di post combustione
- Ventilatori tangenziali di serie

- Extractable ash drawer
- Cast iron-vermiculite hearth
- Ceramic glass heat-resistant 750°C
- Door in cast iron
- Adjustable primary and secondary air, preset tertiary air with post combustion system
- Standard tangential fans

- Tiroir pour cendres extractible
- Foyer en fonte-vermiculite
- Vitre céramique résistant jusqu'à 750°
- Porte en fonte
- Air primaire et secondaire réglables, air tertiaire pré-calibré avec système post combustion
- Ventilateurs tangentiels de série
- **Flamme Verte: Appareil de class 7★**







- Ausziehbarer Aschenbehälter
- Feuerraum aus Gusseisen-Vermiculit
- Glaskeramikfenster, hitzebeständig bis auf 750°
- Tür aus Gusseisen
- Verstellbare Primär und Sekundärluft,

- voraustaritierte Tertiärluft mit Nachverbrennungssystem
- Serienmäßige Tangentialventilatoren

- Cenicero extraíble
- Hierro fundido de 8 y 16 mm
- Cristal cerámico resistente hasta 750°C
- Puerta de hierro fundido
- Aire primaria y secundaria regulable
- Ventiladores tangenciales de serie

### DATI TECNICI



 595x500x440	 Ghisa/Refrattario
 124	% 80,8
 465x250	 1,9
 370x260x300	∅ 160

### CERTIFICAZIONI

**15a B-VG**

**BlmSchV**



### TECNOLOGIA

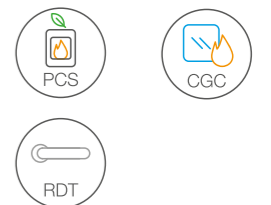



Focolare in ghisa / Cast iron hearth  
Foyer en fonte / Feuerstelle aus Gusseisen  
/ Hogar de hierro fundido



Deflettore e valvola fumi in ghisa  
Smoke deflector and valve in cast-iron  
Déflecteur et vanne fumées en fonte  
Rauchumlenkung und Rauchventil aus  
Gusseisen  
Deflector y válvula de humos en fundición



Focolare in ghisa-Nordiker / Cast iron-  
Nordiker hearth / Foyer en fonte-Nordiker /  
Feuerstelle aus Gusseisen-Nordiker / Hogar  
de hierro fundido-Nordiker



Aria primaria / Primary air / Air primaire /  
Primärluft / Aire primario

## INSERTO 70 - VENTILATO\*

**A** | 9,8 kW-N | 281 m<sup>3</sup>

### PLUS

- Cassetto cenere estraibile
- Ghisa da 8 e 16 mm
- Vetro ceramico resistente fino a 750°
- Porta in ghisa
- Aria primaria e secondaria regolabile
- Ventilatori tangenziali di serie

- Extractable ash drawer
- Cast iron of 8 and 16mm
- Ceramic glass heat-resistant 750°C
- Door in cast iron
- Adjustable primary and secondary air
- Standard tangential fans







- Tiroir pour cendres extractible
- Fonte de 8 à 16 mm
- Vitre céramique résistant jusqu'à 750°
- Porte en fonte
- Air primaire et secondaire réglables
- Ventilateurs tangentiels de série

- Ausziehbarer Aschenbehälter
- Gusseisen, Stärke 8 und 16 mm
- Glaskeramikfenster, hitzebeständig bis auf 750°
- Tür aus Gusseisen
- Verstellbare Primär und Sekundärluft
- Serienmäßige Tangentialventilatoren

- Cenicero extraíble
- Hierro fundido de 8 y 16 mm
- Cristal cerámico resistente hasta 750°C
- Puerta de hierro fundido
- Aire primaria y secundaria regulable
- Ventiladores tangenciales de serie



### DATI TECNICI

 695x550x450	 Ghisa
 142	% 80,0
 565x250	 3,0
 520x280x300	∅ 160



### CERTIFICAZIONI

**15a B-VG**

### TECNOLOGIA



## INSERTO 70 4.0 - VENTILATO

**A** | 7,8 kW-N | 223 m<sup>3</sup>

### PLUS

- Cassetto cenere estraibile
- Focolare in ghisa-Nordiker
- Vetro ceramico resistente fino a 750° C
- Porta in ghisa
- Aria primaria e secondaria regolabile, aria terziaria pretrata con sistema di post combustione
- Ventilatori tangenziali di serie

- Extractable ash drawer
- Hearth in cast-iron and Nordiker
- Ceramic glass heat-resistant 750°C
- Door in cast iron
- Adjustable primary and secondary air, preset tertiary air with post combustion system
- Standard tangential fans

- Tiroir pour cendres extractible
- Foyer en fonte Nordiker
- Vitre céramique résistant jusqu'à 750°
- Porte en fonte
- Air primaire et secondaire réglables, air tertiaire pré-calibré avec système post combustion
- Ventilateurs tangentiels de série
- **Flamme Verte: Appareil de class 7★**

- Ausziehbarer Aschenbehälter
- Feuerstelle aus Nordiker-Gusseisen
- Glaskeramikfenster, hitzebeständig bis auf 750°
- Tür aus Gusseisen
- Verstellbare Primär und Sekundärluft,







voraustarierte Tertiärluft mit Nachverbrennungssystem

• Serienmäßige Tangentialventilatoren

- Cenicero extraíble
- Hogar de hierro fundido- Nordiker
- Cristal cerámico resistente hasta 750°C
- Puerta de hierro fundido
- Aire primaria y secundaria regulable, aire terciaria con sistema de postcombustion precalibrado
- Ventiladores tangenciales de serie



### DATI TECNICI

 695x550x450	 Ghisa/Nordiker
 142	% 79,1
 565x245	 2,3
 415x310x300	∅ 160



### CERTIFICAZIONI

**BlmSchV**



### TECNOLOGIA

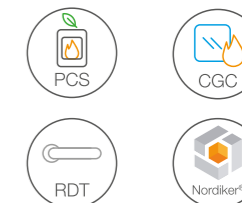

\* Fino ad esaurimento scorte - while stocks last - Jusqu'à épuisement des stocks - Solange der Vorrat reicht - Hasta agotamiento stocks



Aria primaria / Primary air / Air primaire / Primärluft / Aire primario



Focolare in ghisa-Nordiker / Cast iron-Nordiker hearth / Foyer en fonte-Nordiker / Feuerstelle aus Gusseisen-Nordiker / Hogar de hierro fundido-Nordiker

## INSERTO 70 4.0 TONDO - VENTILATO







**A** | 7,8 kW-N | 223 m<sup>3</sup>



### PLUS

- Cassetto cenere estraibile
- Focolare in ghisa-Nordiker
- Vetro ceramico resistente fino a 750° C in pezzo unico
- Porta in ghisa
- Aria primaria e secondaria regolabile, aria terziaria prearata con sistema di post combustione
- Ventilatori tangenziali di serie
- Standard tangential fans
- Tiroir pour cendres extractible
- Foyer en fonte Nordiker
- Vitre céramique résistant à 750° C en une seule pièce
- Porte en fonte
- Air primaire et secondaire réglables, air tertiaire pré-calibré avec système post combustion
- Ventilateurs tangentiels de série
- **Flamme Verte: Appareil de class 7★**
- Ausziehbarer Aschenbehälter
- Feuerstelle aus Nordiker-Gusseisen
- Glaskeramikfenster, hitzebeständig bis auf 750°C, an einem Stück
- Tür aus Gusseisen
- Verstellbare Primär und Sekundärluft, voraustarierte Tertiärluft mit Nachverbrennungssystem
- Serienmäßige Tangentialventilatoren
- Cenicero extraíble
- Hogar de hierro fundido- Nordiker
- Cristal cerámico resistente hasta 750° C en un bloque único
- Puerta de hierro fundido
- Aire primaria y secundaria regulable, aire terciaria con sistema de postcombustion precalibrado
- Ventiladores tangenciales de serie

### DATI TECNICI

 690X550X540	 Ghisa/Nordiker
 162	% 79,1
 510X245	 2,3
 415X310X380	∅ 160



### CERTIFICAZIONI



### TECNOLOGIA



Aria primaria / Primary air / Air primaire / Primärluft / Aire primario



Cassetto cenere estraibile  
Extractable ash drawer  
Tiroir pour cendres extractible  
Ausziehbarer Aschenbehälter  
Cenicero extraíble

## INSERTO 70 H49 - VENTILATO







**A** | 9,8 kW-N | 281 m<sup>3</sup>



### PLUS

- Cassetto cenere estraibile
- Ghisa da 8 e 16 mm
- Vetro ceramico resistente fino a 750° C
- Aria primaria e secondaria regolabile
- Ventilatori tangenziali di serie
- Tiroir pour cendres extractible
- Fonte de 8 à 16 mm
- Vitre céramique résistant jusqu'à 750°
- Air primaire et secondaire réglables
- Ventilateurs tangentiels de série
- Cenicero extraíble
- Hierro fundido de 8 y 16 mm
- Cristal cerámico resistente hasta 750°C
- Aire primaria y secundaria regulable
- Ventiladores tangenciales de serie
- Extractable ash drawer
- Cast iron of 8 and 16mm
- Ceramic glass heat-resistant 750°C
- Adjustable primary and secondary air
- Standard tangential fans
- Ausziehbarer Aschenbehälter
- Gusseisen, Stärke 8 und 16 mm
- Glaskeramikfenster, hitzebeständig bis auf 750°
- Verstellbare Primär und Sekundärluft
- Serienmäßige Tangentialventilatoren

### DATI TECNICI

 695x495x450	 Ghisa
 136	% 80,0
 565x197	 3,0
 520x280x300	∅ 160



### CERTIFICAZIONI

15a B-VG

### TECNOLOGIA

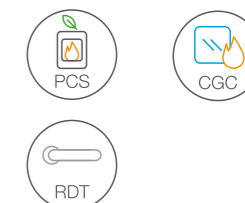





Aria primaria / Primary air / Air primaire / Primärluft / Aire primario

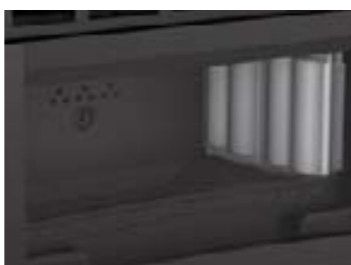

Focolare in ghisa-Nordiker / Cast iron-Nordiker hearth / Foyer en fonte-Nordiker / Feuerstelle aus Gusseisen-Nordiker / Hogar de hierro fundido-Nordiker

## INSERTO 70 H49 4.0 - VENTILATO







**A+** | 6,7 kW-N | 192 m<sup>3</sup>



### PLUS

- Cassetto cenere estraibile
- Focolare in ghisa-Nordiker
- Vetro ceramico resistente fino a 750° C
- Porta in ghisa
- Aria primaria e secondaria regolabile, aria terziaria pretrata con sistema di post combustione
- Ventilatori tangenziali di serie
- Extractable ash drawer
- Hearth in cast-iron and Nordiker
- Ceramic glass heat-resistant 750°C
- Door in cast iron
- Adjustable primary and secondary air, preset tertiary air with post combustion system
- Standard tangential fans
- Tiroir pour cendres extractible
- Foyer en fonte Nordiker
- Vitre céramique résistant jusqu'à 750°
- Porte en fonte
- Air primaire et secondaire réglables, air tertiaire pré-calibré avec système post combustion
- Ventilateurs tangentiels de série
- **Flamme Verte: Appareil de class 7★**
- Ausziehbarer Aschenbehälter
- Feuerstelle aus Nordiker-Gusseisen
- Glaskeramikfenster, hitzebeständig bis auf 750°
- Tür aus Gusseisen
- Verstellbare Primär und Sekundärluft,
- voraustarierte Tertiärluft mit Nachverbrennungssystem
- Serienmäßige Tangentialventilatoren
- Cenicero extraíble
- Hogar de hierro fundido- Nordiker
- Cristal cerámico resistente hasta 750°C
- Puerta de hierro fundido
- Aire primaria y secundaria regulable, aire terciaria con sistema de postcombustion precalibrado
- Ventiladores tangenciales de serie

### DATI TECNICI

 695x495x500	 Ghisa/Nordiker
 149	% 82,0
 465x187	 1,9
 440x270x285	∅ 160



### CERTIFICAZIONI

**15a B-VG**  
**BlmSchV**  

### TECNOLOGIA



Aria primaria / Primary air / Air primaire / Primärluft / Aire primario

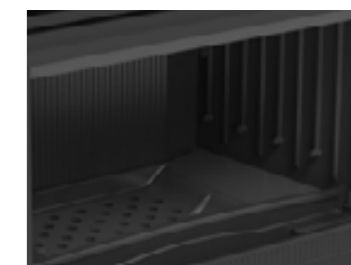

Focolare in ghisa / Cast iron hearth / Foyer en fonte / Feuerstelle aus Gusseisen / Hogar de fundición.

## INSERTO 70 L - VENTILATO







**A** | 9,0 kW-N | 258 m<sup>3</sup>



### PLUS

- Cassetto cenere estraibile
- Ghisa da 8 e 16 mm
- Vetro ceramico resistente fino a 750°
- Aria primaria e secondaria regolabile
- Ventilatori tangenziali di serie
- Extractable ash drawer
- Cast iron of 8 and 16mm
- Ceramic glass heat-resistant 750°C
- Adjustable primary and secondary air
- Standard tangential fans
- Tiroir pour cendres extractible
- Fonte de 8 à 16 mm
- Vitre céramique résistante jusqu'à 750°
- Air primaire et secondaire réglables
- Ventilateurs tangentiels de série
- Ausziehbarer Aschenbehälter
- Gusseisen, Stärke 8 und 16 mm
- Glaskeramikfenster, hitzebeständig bis auf 750°
- Verstellbare Primär und Sekundärluft
- Serienmäßige Tangentialventilatoren
- Cenicero extraíble
- Hierro fundido de 8 y 16 mm
- Cristal cerámico resistente hasta 750°C
- Aire primaria y secundaria regulable
- Ventiladores tangenciales de serie

### DATI TECNICI

 695x550x450	 Ghisa
 128	% 78,1
 565x250	 2,7
 520x330x300	∅ 160



### CERTIFICAZIONI

**BlmSchV**

### TECNOLOGIA

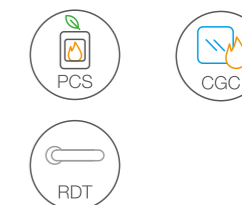



Aria primaria / Primary air / Air primaire / Primärluft / Aire primario



Focolare in ghisa-vermiculite  
Cast iron-vermiculite hearth  
Foyer en fonte-vermiculite  
Feuerraum aus Gusseisen-Vermiculit  
Hogar en fundición-vermiculita

## INSERTO 70 L 4.0 - VENTILATO

**A** | 7,8 kW-N | 223 m<sup>3</sup>



### PLUS

- Cassetto cenere estraibile
- Focolare in ghisa-vermiculite
- Vetro ceramico resistente fino a 750° C
- Porta in ghisa
- Aria primaria e secondaria regolabile, aria terziaria pretrata con sistema di post combustione
- Ventilatori tangenziali di serie

- Extractable ash drawer
- Cast iron-vermiculite hearth
- Ceramic glass heat-resistant 750°C
- Door in cast iron
- Adjustable primary and secondary air, preset tertiary air with post combustion system
- Standard tangential fans

- Tiroir pour cendres extractible
- Foyer en fonte-vermiculite
- Vitre céramique résistant jusqu'à 750° C
- Porte en fonte
- Air primaire et secondaire réglables, air tertiaire pré-calibré avec système post combustion
- Ventilateurs tangentiels de série
- **Flamme Verte: Appareil de class 7★**

- Ausziehbarer Aschenbehälter
- Feuerraum aus Gusseisen-Vermiculit
- Glaskeramikfenster, hitzebeständig bis auf 750°
- Tür aus Gusseisen
- Verstellbare Primär und Sekundärluft,

voraustarierte Tertiärluft mit Nachverbrennungssystem  
• Serienmäßige Tangentialventilatoren

- Cenicero extraíble
- Hogar en fundición-vermiculita
- Cristal cerámico resistente hasta 750°C
- Puerta de hierro fundido
- Aire primaria y secundaria regulable, aire terciaria con sistema de postcombustion precalibrado
- Ventiladores tangenciales de serie

### DATI TECNICI

 695x550x450

 Ghisa/Refrattario

 128

% 79,1

 565x245

 2,3

 425x310x300

∅ 160



### CERTIFICAZIONI

**BlmSchV**



### TECNOLOGIA



Cassetto cenere estraibile  
Extractable ash drawer  
Tiroir pour cendres extractible  
Ausziehbarer Aschenbehälter  
Cenicero extraíble



Regolazione aria primaria e secondaria  
Adjustable primary and secondary air  
Air première et secondaire réglable  
Verstellbare Primär - und Sekundärluft  
Regulación aire primario y secundario

## INSERTO 50 VERTICALE CRYSTAL BII - VENTILATO

**A+** | 8,3 kW-N | 237 m<sup>3</sup>

### PLUS

- Cassetto cenere estraibile
- Focolare in ghisa-Nordiker
- Vetro ceramico resistente fino a 750° C
- Ventilatori tangenziali di serie
- Aria primaria e secondaria regolabile, aria terziaria pretrata con sistema di post combustione
- Possibilità autonoma di cambiare l'apertura destra o sinistra della porta

- Extractable ash drawer
- Hearth in cast-iron and Nordiker
- Ceramic glass heat-resistant 750°C
- Standard tangential fans
- Adjustable primary and secondary air, preset tertiary air with post combustion system
- Possibility to change by yourself the door opening direction from right to left

- Tiroir pour cendres extractible
- Foyer en fonte Nordiker
- Vitre céramique résistant jusqu'à 750° C
- Ventilateurs tangentiels de série
- Air primaire et secondaire réglables, air tertiaire pré-calibré avec système post combustion
- Possibilité de changer en autonomie l'ouverture de la porte vers droite ou gauche
- **Flamme Verte: Appareil de class 7★**

- Ausziehbarer Aschenbehälter
- Feuerstelle aus Nordiker-Gusseisen
- Glaskeramikfenster, hitzebeständig bis auf 750°
- Serienmäßige Tangentialventilatoren
- Verstellbare Primär und Sekundärluft,

voraustarierte Tertiärluft mit Nachverbrennungssystem  
• Möglichkeit, selbständig die Öffnungsrichtung der Tür nach rechts oder nach links zu ändern

- Cenicero extraíble
- Hogar de hierro fundido- Nordiker
- Cristal cerámico resistente hasta 750°C
- Ventiladores tangenciales de serie
- Aire primaria y secundaria regulable, aire terciaria con sistema de postcombustion precalibrado
- Posibilidad autónoma de mudar la abertura derecha o izquierda de la puerta

### DATI TECNICI

 500x800x500

 Ghisa - Nordiker

 115

% 81

 335X347

 2,4

 300x400x360

∅ 150



### CERTIFICAZIONI

**15a B-VG**

**BlmSchV**



### TECNOLOGIA





Focolare in ghisa-Nordiker / Hearth in cast-iron and Nordiker / Foyer en fonte Nordiker / Feuerstelle aus Nordiker-Gusseisen / Hogar de hierro fundido- Nordiker



Elemento rastremato per facilitare l'installazione  
Shaped Element for an easy installation  
Élément façonné pour une installation facile  
Geformter Teil für eine einfache Installation  
Elemento ahusado para facilitar su instalación

# INSERTO 70 CRYSTAL - VENTILATO\*

**A** | 9,0 kW-N | 258 m<sup>3</sup>



## PLUS

- Cassetto cenere estraibile
- Focolare in ghisa-Nordiker
- Vetro ceramico resistente fino a 750° C
- Ventilatori tangenziali di serie
- Aria primaria e secondaria regolabile, aria terziaria prearata con sistema di post combustione
- Possibilità autonoma di cambiare l'apertura destra o sinistra della porta
- Extractable ash drawer
- Hearth in cast-iron and Nordiker
- Ceramic glass heat-resistant 750°C
- Standard tangential fans
- Adjustable primary and secondary air, preset tertiary air with post combustion system
- Possibility to change by yourself the door opening direction from right to left
- Tiroir pour cendres extractible
- Foyer en fonte Nordiker
- Vitre céramique résistant jusqu'à 750° C
- Ventilateurs tangentiels de série
- Air primaire et secondaire réglables, air tertiaire pré-calibré avec système post combustion
- Possibilité de changer en autonomie l'ouverture de la porte vers droite ou gauche
- Flamme Verte: Appareil de class 7★
- Ausziehbarer Aschenbehälter
- Feuerstelle aus Nordiker-Gusseisen
- Glaskeramikfenster, hitzebeständig bis auf 750°
- Serienmäßige Tangentialventilatoren
- Verstellbare Primär und Sekundärluft,

- voraustarierte Tertiärluft mit Nachverbrennungssystem
- Möglichkeit, selbständig die Öffnungsrichtung der Tür nach rechts oder nach links zu ändern
- Cenicero extraible
- Hogar de hierro fundido- Nordiker
- Cristal cerámico resistente hasta 750°C
- Ventiladores tangenciales de serie
- Aire primaria y secundaria regulable, aire terciaria con sistema de postcombustion precalibrado
- Posibilidad autónoma de mudar la abertura derecha o izquierda de la puerta

## DATI TECNICI

700x555x500	Ghisa - Nordiker
124	% 78,2
540x245	2,7
500x320x360	Ø 160



## CERTIFICAZIONI



## TECNOLOGIA

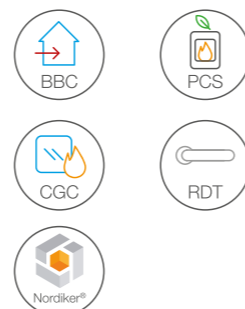

Porta panoramica in vetro ceramico  
Door with one-piece ceramic glass  
Porte avec la vitre céramique en pièce unique  
Tuer mit einteiliger Keramikscheibe  
Puerta con cristal cerámico en pieza única



Regolazione aria primaria e secondaria  
Adjustable primary and secondary air  
Air première et secondaire réglable  
Verstellbare Primär - und Sekundärluft  
Regulación aire primario y secundario

# INSERTO 80 CRYSTAL EVO 2.0 - VENTILATO

**A+** | 7,4 kW-N | 212 m<sup>3</sup>

## PLUS

- Cassetto cenere estraibile
- Focolare in ghisa-Nordiker
- Vetro ceramico resistente fino a 750° C
- Ventilatori tangenziali di serie
- Aria primaria e secondaria regolabile, aria terziaria prearata con sistema di post combustione
- Possibilità autonoma di cambiare l'apertura destra o sinistra della porta
- Extractable ash drawer
- Hearth in cast-iron and Nordiker
- Ceramic glass heat-resistant 750°C
- Standard tangential fans
- Adjustable primary and secondary air, preset tertiary air with post combustion system
- Possibility to change by yourself the door opening direction from right to left
- Tiroir pour cendres extractible
- Foyer en fonte Nordiker
- Vitre céramique résistant jusqu'à 750° C
- Ventilateurs tangentiels de série
- Air primaire et secondaire réglables, air tertiaire pré-calibré avec système post combustion
- Possibilité de changer en autonomie l'ouverture de la porte droite ou gauche
- Flamme Verte: Appareil de class 7★
- Ausziehbarer Aschenbehälter
- Feuerstelle aus Nordiker-Gusseisen
- Glaskeramikfenster, hitzebeständig bis auf 750°
- Serienmäßige Tangentialventilatoren
- Verstellbare primär und Sekundärluft, voraustarierte Tertiärluft mit Nachverbrennungssystem
- Möglichkeit, selbständig die Öffnungsrichtung der Tür nach rechts oder nach links zu ändern
- Cenicero extraible
- Hogar de hierro fundido- Nordiker
- Cristal cerámico resistente hasta 750°C
- Ventiladores tangenciales de serie
- Aire primaria y secundaria regulable, aire terciaria con sistema de postcombustion precalibrado
- Posibilidad autónoma de mudar la abertura derecha o izquierda de la puerta



## DATI TECNICI

800x555x500	Ghisa - Nordiker
130	% 83,9
635x245	2,1
600x310x360	Ø 160



## CERTIFICAZIONI



## TECNOLOGIA

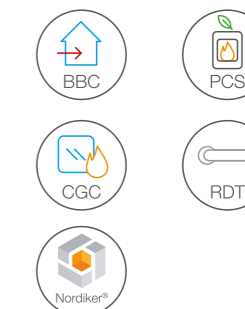

\* Fino ad esaurimento scorte - while stocks last - Jusqu'à épuisement des stocks - Solange der Vorrat reicht - Hasta agotamiento stocks

## Giro aria con ventilazione attiva

Air circulation with enabled ventilation / Renouvellement d'air avec ventilation active / Luftkreis bei eingeschalteter Belüftung / Circulación de aire con ventilación activa

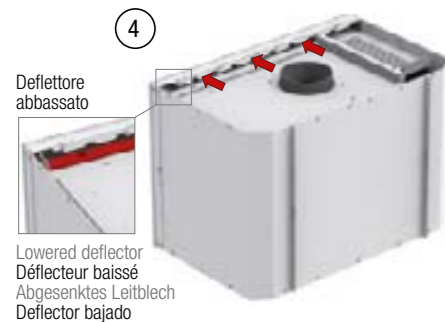
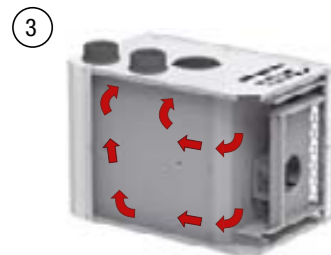
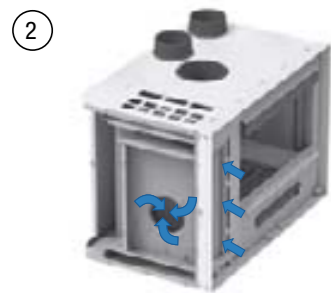

**Opzione 1:** con uscita frontale dell'aria  
**Option 1:** with front air outlet  
**Option 1:** avec sortie frontale de l'air  
**Option 1:** mit frontalem Luftausgang  
**Opción 1:** con salida frontal del aire

Lowered deflector  
 Déflecteur baissé  
 Abgesenktes Leitblech  
 Deflector bajado

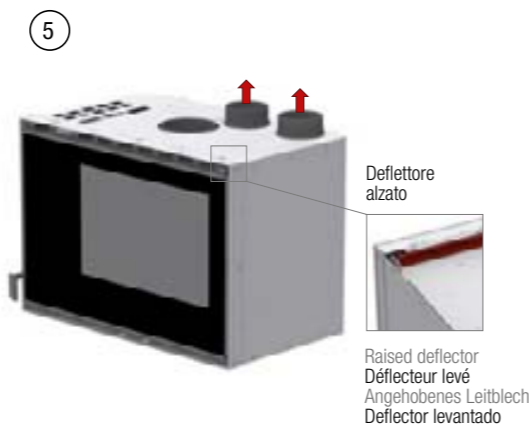

**Opzione 2:** con uscita alle canalizzazioni  
**Option 2:** with outlet to canalizations  
**Option 2:** avec sortie aux conduits  
**Option 2:** mit Ausgang an den Kanalisierungen  
**Opción 2:** con salida hacia las canalizaciones

Raised deflector  
 Déflecteur levé  
 Angehobenes Leitblech  
 Deflector levantado









# INSERTO 80 HIGH PRESSURE

**A+** | 7,9 kW-N | 226 m<sup>3</sup>

## PLUS

- Sistema di ventilazione canalizzabile di serie
  - Cassetto cenere estraibile
  - Focolare in ghisa-Nordiker
  - Vetro ceramico resistente fino a 750°
  - Porta in ghisa
  - Ventilatore centrifugo High Pressure
  - Centralina regolazione digitale con telecomando
  - Aria primaria e secondaria regolabile, aria terziaria prearata con sistema di post combustione
- Standard ventilation system that can be channelled
  - Extractable ashbox
  - Hearth in cast-iron and Nordiker
  - Ceramic glass resistant up to 750°
  - Door in cast iron
  - High Pressure Centrifugal fan
  - Digital adjustment control unit with remote control
  - Adjustable primary and secondary air, preset tertiary air with post combustion system
- Système de ventilation canalisable de série
  - Tiroir pour cendres extractible
  - Foyer en fonte Nordiker
  - Vitre céramique résistante jusqu'à 750° C
  - Porte en fonte
  - Ventilateur centrifuge High Pressure (Haute Pression)
  - Centrale de réglage numérique avec télécommande
  - Air primaire et secondaire réglables, air tertiaire pré-calibré avec système post combustion
  - Flamme Verte: Appareil de class 7★
- Serienmäßig kanalisierbares Belüftungssystem
  - Ausziehbarer Aschenbehälter
  - Feuerstelle aus Nordiker-Gusseisen
  - Glaskeramikfenster, hitzebeständig bis auf 750°
  - Tür aus Gusseisen
  - Hochdruck-Zentrifugalventilator
  - Einstellbares Digital-Steuergerät mit Fernbedienung
  - Verstellbare primär und Sekundärluft, voraustarierte Tertiärluft mit Nachverbrennungssystem
- Sistema de ventilación canalizable de serie
  - Cenicero extraíble
  - Hogar de hierro fundido- Nordiker
  - Cristal cerámico resistente hasta 750°C
  - Puerta de hierro fundido
  - Ventilador centrífugo High Pressure
  - Centralita d regulación digital con mando a distancia
  - Aire primaria y secundaria regulable, aire terciaria con sistema de postcombustion precalibrado

## DATI TECNICI

 800x555x520	 Ghisa - Nordiker
 128	 82,4
 500x230	 2,3
 490x290x330	 160

## CERTIFICAZIONI

15a B-VG

BlmSchV



## TECNOLOGIA

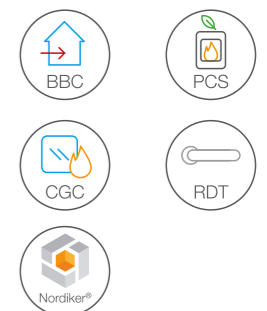

INSERTI 



Power Radiant System



## INSERTO 80 PRS CRYSTAL - VENTILATO

**A+** | 8,3 kW-N | 237 m<sup>3</sup>

### PLUS

- Sistema Power Radiant System
- Cassetto cenere estraibile frontalmente
- Porta in ghisa
- Focolare in ghisa-Nordiker
- Ventilatori tangenziali di serie
- Apertura porta reversibile

- Power Radiant System (PRS)
- Front extractable ash drawer
- Cast Iron Door
- Cast iron and Nordiker Firebox
- Standard Tangential fans
- Reversible door opening







- Système Radiant
- Tiroir à cendres extractible à l'avant
- Porte en Fonte
- Foyer en Fonte Nordiker
- Ventilateurs Tangentiels standard
- Ouverture de porte réversible, fournie d'office à gauche
- **Flamme Verte: Appareil de class 7★**

- Power Radiant System
- Frontal ausziehbarer Aschekasten
- Feuerraumtür aus Gusseisen
- Brennraum aus Gusseisen und Nordiker-Schamott
- Inklusiver Raumlüfter
- Austauschbarer Anschlag

- Sistema POWER RADIANT SYSTEM
- Cajón de la ceniza extraíble frontalmente
- Puerta de hierro fundido
- Ventiladores tangenciales de serie
- Puerta con apertura reversible



### DATI TECNICI

 800x916x500	 Ghisa - Nordiker
 150	% 87,4
 635x245	 2,2
 600x310x360	∅ 160



### CERTIFICAZIONI

15a B-VG

BlmSchV



### TECNOLOGIA

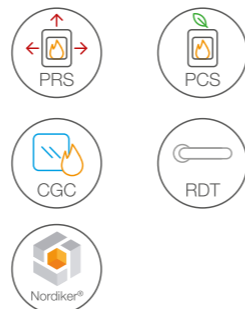

## INSERTO 100 CRYSTAL - VENTILATO

**A** | 9,5 kW-N | 272 m<sup>3</sup>

### PLUS

- Cassetto cenere estraibile
- Focolare in ghisa-Nordiker
- Vetro ceramico resistente fino a 750° C
- Ventilatori tangenziali di serie
- Aria primaria e secondaria regolabile
- Possibilità autonoma di cambiare l'apertura destra o sinistra della porta

- Extractable ash drawer
- Hearth in cast-iron and Nordiker
- Ceramic glass heat-resistant 750°C
- Standard tangential fans
- Adjustable primary and secondary air
- Possibility to change by yourself the door opening direction from right to left

- Tiroir pour cendres extractible
- Foyer en fonte Nordiker
- Vitre céramique résistant jusqu'à 750° C
- Ventilateurs tangentiels de série
- Air primaire et secondaire réglables
- Possibilité de changer en autonomie l'ouverture de la porte vers droite ou gauche
- **Flamme Verte: Appareil de class 7★**

- Ausziehbarer Aschenbehälter
- Feuerstelle aus Nordiker-Gusseisen
- Glaskeramikfenster, hitzebeständig bis auf 750°
- Serienmäßige Tangentialventilatoren
- Verstellbare Primär und Sekundärluft

- Möglichkeit, selbständig die Öffnungsrichtung der Tür nach rechts oder nach links zu ändern

- Cenicero extraíble
- Hogar de hierro fundido- Nordiker
- Cristal cerámico resistente hasta 750°C
- Ventiladores tangenciales de serie
- Aire primaria y secundaria regulable
- Posibilidad autónoma de mudar la abertura derecha o izquierda de la puerta









Cassetto cenere estraibile / Extractable ash drawer / Tiroir pour cendres extractible / Ausziehbarer Aschenbehälter / Cenicero extraíble



Possibilità autonoma di cambiare l'apertura destra o sinistra della porta  
Possibility to change the right or left opening of the door  
Possibilité de changer en autonomie l'ouverture de la porte vers droite ou vers gauche  
Möglichkeit, selbständig die Öffnungsrichtung der Tür nach rechts oder nach links zu ändern  
Posibilidad autónoma de mudar la abertura derecha o izquierda de la puerta



### DATI TECNICI

 1000x555x500	 Ghisa - Nordiker
 156	% 78,2
 835x245	 2,8
 785x320x360	∅ 160



### CERTIFICAZIONI

BlmSchV



### TECNOLOGIA



INSERTI 



Visione frontale e laterale del fuoco  
Front and side view of the fire  
Vision frontale et latérale du feu  
Vordere und seitliche Ansicht des Feuers  
Vista frontal y lateral del fuego

OPTIONAL



# INSERTO 70 CRYSTAL 3 LATI

**A+** | 9,7 kW-N | 278 m<sup>3</sup>









PLUS

- Cassetto cenere estraibile
- Focolare in ghisa e Nordiker
- Vetri ceramici resistenti fino a 750°
- Porta in ghisa
- Visione frontale e laterale del fuoco
- Aria primaria e secondaria regolabile, aria terziaria prearata con sistema di post combustione
- Possibilità autonoma di cambiare l'apertura destra o sinistra della porta
- Senza motori di ventilazione
- Extractable ash drawer
- Hearth in cast-iron and Nordiker
- Ceramic glass heat-resistant 750°C
- Door in cast iron
- Front and side view of the fire
- Adjustable primary and secondary air, preset tertiary air with post combustion system
- Possibility to change by yourself the door opening direction from right to left

- Without fan motors
- Tiroir pour cendres extractible
- Foyer en fonte et Nordiker
- Vitres céramiques résistant jusqu'à 750°
- Porte en fonte
- Vision frontale et latérale du feu
- Air primaire et secondaire réglables, air tertiaire pré-calibré avec système post combustion
- Possibilité de changer en autonomie l'ouverture de la porte vers droite ou gauche
- Sans moteurs de ventilation
- **Flamme Verte: Appareil de class 7★**
- Ausziehbarer Aschenbehälter
- Feuerstelle aus Gusseisen und Nordiker
- Keramikgläser, hitzebeständig bis auf 750°
- Tür aus Gusseisen
- Vordere und seitliche Ansicht des Feuers

- Verstellbare Primär und Sekundärluft, voraustarierte Tertiärluft mit Nachverbrennungssystem
- Möglichkeit, selbständig die Öffnungsrichtung der Tür nach rechts oder nach links zu ändern
- Ohne Gebläsemotoren
- Cenicero extraible
- Hogar de hierro fundido e Nordiker
- Cristal cerámico resistente hasta 750°C
- Puerta de hierro fundido
- Vista frontal y lateral del fuego
- Aire primaria y secundaria regulable, aire terciaria con sistema de postcombustion precalibrado
- Posibilidad autónoma de mudar la abertura derecha o izquierda de la puerta
- Sin motores de ventilación

DATI TECNICI

 755x554x510	 Ghisa - Nordiker
 134	% 82,0
 540x224	 2,7
 660x290x360	∅ 160

CERTIFICAZIONI



TECNOLOGIA

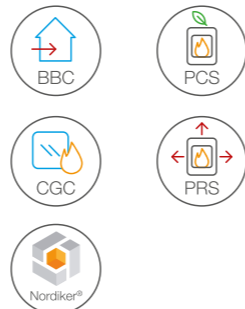

Il prodotto può essere trasformato con il lato vetro a sinistra, in modo semplice durante la fase di installazione.  
The product can be transformed by simply placing the glass side on the left during the installation phase.

Le produit peut être transformé avec le côté vitre à gauche, simplement durant la phase d'installation.  
Das Produkt kann während der Installation auf einfache Weise umgestaltet werden, wodurch das Glas sich links befindet.  
El producto puede ser transformado con el lado de vidrio a la izquierda, de manera simple, durante la fase de instalación.

OPTIONAL



# INSERTO 70 CRYSTAL ANGOLO

**A** | 9,2 kW-N | 263 m<sup>3</sup>









PLUS

- Cassetto cenere estraibile
- Focolare in ghisa e Nordiker
- Vetri ceramici resistenti fino a 750°
- Porta in ghisa
- Il prodotto può essere trasformato con il lato vetro a sinistra
- Aria primaria e secondaria regolabile, aria terziaria prearata con sistema di post combustione
- Possibilità autonoma di cambiare l'apertura destra o sinistra della porta
- Senza motori di ventilazione
- Extractable ash drawer
- Hearth in cast-iron and Nordiker
- Ceramic glass heat-resistant 750°C
- Door in cast iron
- The product can be transformed with the glass side on the left
- Adjustable primary and secondary air, preset tertiary air with post combustion system
- Possibility to change by yourself the door

- opening direction from right to left
- Without fan motors
- Tiroir pour cendres extractible
- Foyer en fonte et Nordiker
- Vitres céramiques résistant jusqu'à 750° C
- Porte en fonte
- Le produit peut être transformé avec le côté vitre à gauche
- Air primaire et secondaire réglables, air tertiaire pré-calibré avec système post combustion
- Possibilité de changer en autonomie l'ouverture de la porte vers droite ou gauche
- Sans moteurs de ventilation
- **Flamme Verte: Appareil de class 7★**
- Ausziehbarer Aschenbehälter
- Feuerstelle aus Gusseisen und Nordiker
- Keramikgläser, hitzebeständig bis auf 750°
- Tür aus Gusseisen
- Das Produkt kann umgeändert werden,

- damit sich die Glasseite links befindet.
- Verstellbare Primär und Sekundärluft, voraustarierte Tertiärluft mit Nachverbrennungssystem
- Möglichkeit, selbständig die Öffnungsrichtung der Tür nach rechts oder nach links zu ändern
- Ohne Gebläsemotoren
- Cenicero extraible
- Hogar de hierro fundido e Nordiker
- Cristal cerámico resistente hasta 750°C
- Puerta de hierro fundido
- El producto puede transformarse montando el lado del cristal a la izquierda
- Aire primaria y secundaria regulable, aire terciaria con sistema de postcombustion precalibrado
- Posibilidad autónoma de mudar la abertura derecha o izquierda de la puerta
- Sin motores de ventilación

DATI TECNICI

 755x554x510	 Ghisa - Nordiker
 133	% 78,0
 540x224	 2,7
 603x290x360	∅ 160

CERTIFICAZIONI



TECNOLOGIA





OPTIONAL



Kit "Wind Air"



Shade diffuser



Wave diffuser

# INSERTO 70 WIDE









**A+** | 7,5 kW-N | 215 m<sup>3</sup>

PLUS

- Cassetto cenere estraibile
- Griglia e porta in ghisa G20
- Focolare in Nordiker
- Apertura porta reversibile
- Senza motori di ventilazione (ventilazione optional con Kit Wind Air)
- Piano fuoco ribassato per maggiore visione della fiamma
- Aria 1<sup>a</sup> e 2<sup>a</sup> regolabili con unico registro, aria terziaria pretrata con sistema di post-combustione
- Possibilità di prelevare l'aria comburente dall'esterno
- Extractable ash drawer
- Cast Iron Grid and Door G20
- Nordiker hearth
- Reversible door opening
- Without fan ventilation (optional ventilation with Kit Wind Air)
- Low-floor fire plain for great flame vision
- Adjustable primary and secondary air, pre-calibrated tertiary with post combustion system
- External air intake (BBC)
- Tiroir à cendres extractible
- Grille et porte en Fonte G20
- Foyer en Nordiker
- Ouverture de porte réversible, fournie d'office à gauche
- Sans moteurs de ventilation (ventilation optionale avec Kit Wind Air)
- Plat de feu baissé pour meilleure vision du feu
- Air 1<sup>er</sup> et 2<sup>e</sup> réglables avec registre unique, air tertiaire avec système de post-combustion
- Air de combustion BBC
- Herausziehbarer Aschenkasten
- Gitter und Tür aus Gusseisen G20
- Feuerstelle aus Nordiker
- Öffnung mit umkehrbarer Tür

- Ohne Gebläsemotoren (Belüftung optional mit Kit Wind Air)
- Abgesenkte Feuerfläche für eine bessere Sicht der Flamme
- Verstellbare Primär und Sekundärluft mit einem einzigen Regler, voraustrierte Tertiärluft mit Nachverbrennungssystem
- Möglichkeit, die Verbrennungsluft von außen zuzuleiten (BBC)
- Cajón de la ceniza extraíble
- Puerta y rejilla de hierro fundido G20
- Hogar de Nordiker
- Puerta con apertura reversible
- Sin motores de ventilación (ventilación opcional con Kit Wind Air)
- Base fogón mas baja para mejorar visión del fuego
- Aire primario y secundario regulable con unico registro, aire terciario precalibrado con sistema de postcombustión
- Aire comburente BBC

DATI TECNICI

 710x561x509	 Nordiker
 137	% 80,7
 527x278	 2,2
 564x265x350	∅ 160



CERTIFICAZIONI

15a B-VG  
BlmSchV



TECNOLOGIA

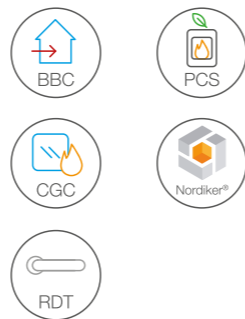

CONTO TERMICO

Per maggiori informazioni consultare il nostro sito:

www.lanordica-extraflame.com



OPTIONAL



Kit "Wind Air"



Shade diffuser



Wave diffuser

# INSERTO 70 PRS WIDE









**A+** | 8,1 kW-N | 232 m<sup>3</sup>

PLUS

- Sistema Power Radiant System
- Piano fuoco ribassato per maggiore visione della fiamma
- Senza motori di ventilazione (ventilazione optional con Kit Wind Air)
- Apertura porta reversibile
- Griglia e porta in ghisa G20
- Focolare in Nordiker
- Cassetto cenere estraibile
- Aria 1<sup>a</sup> e 2<sup>a</sup> regolabili con unico registro, aria terziaria pretrata con sistema di post-combustione
- Possibilità di prelevare l'aria comburente dall'esterno
- Power Radiant System (PRS)
- Lowered fire top for better flame view
- Without fan motors (optional Wind Air Kit ventilation)
- Reversible door opening
- G20 cast iron grille and door
- Nordiker hearth
- Removable ash box
- Adjustable primary and secondary air with a single draft device,
- pre-calibrated tertiary air with post combustion system
- External air intake (BBC)
- Système Radiant
- Plan de brûlage abaissé pour une meilleure vision de la flamme
- Sans moteurs de ventilation (ventilation en option avec kit Wind Air)
- Ouverture de porte réversible
- Grille et porte en fonte G20
- Foyer en Nordiker
- Tiroir à cendres extractible
- Air primaire et secondaire réglables au moyen d'un seul réglage, tandis que l'air tertiaire est pré-étalonné avec un système de postcombustion
- Possibilité de prélever l'air comburant de l'extérieur
- Power Radiant System
- Abgesenkte Feuerfläche für eine bessere Sicht der Flamme
- Ohne Gebläsemotoren (Belüftung optional mit Kit Wind Air)
- Öffnung mit umkehrbarer Tür
- Gitter und Tür aus Gusseisen G20
- Feuerstelle aus Nordiker
- Herausziehbarer Aschenkasten
- Verstellbare Primär und Sekundärluft mit einem einzigen Regler, voraustrierte Tertiärluft mit Nachverbrennungssystem
- Möglichkeit, die Verbrennungsluft von außen zuzuleiten
- Sistema Power Radiant System
- Repisa de fuego rebajado para una mejor visión de la llama
- Sin motores de ventilación (ventilación opcional con el kit Wind Air)
- Apertura de puerta reversible
- Rejilla y puerta de fundición G20
- Hogar de Nordiker
- Cajón para la recogida de cenizas extraíble
- Aire primario y secundario regulables con un solo registro, aire terciario precalibrado con sistema de post-combustión
- Posibilidad de captar el aire comburente del exterior

DATI TECNICI

 710x1050x509	 Nordiker
 155	% 86,1
 527x278	 2,4
 564x265x350	∅ 160



CERTIFICAZIONI

15a B-VG  
BlmSchV



TECNOLOGIA

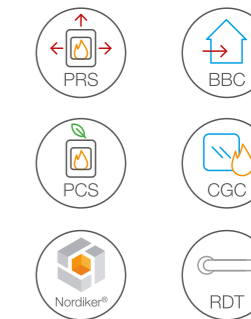



OPTIONAL



Kit "Wind Air"



Shade diffuser



Wave diffuser

# INSERTO 80 WIDE

**A+** | 7,4 kW-N | 212 m<sup>3</sup>



PLUS

- Cassetto cenere estraibile
- Griglia e porta in ghisa G20
- Focolare in Nordiker
- Apertura porta reversibile
- Senza motori di ventilazione
- Piano fuoco ribassato per maggiore visione della fiamma
- Aria 1<sup>a</sup> e 2<sup>a</sup> regolabili con unico registro, aria terziaria pretrata con sistema di post-combustione
- Possibilità di prelevare l'aria comburente dall'esterno
- Extractable ash drawer
- Cast Iron Grid and Door G20
- Nordiker hearth
- Reversible door opening
- Without fan ventilation
- Low-floor fire plain for great flame vision
- Adjustable primary and secondary air, pre-calibrated tertiary with post combustion system
- External air intake (BBC)

- Tiroir à cendres extractible
- Grille et porte en Fonte G20
- Foyer en Nordiker
- Ouverture de porte réversible, fournie d'office à gauche
- Sans moteurs de ventilation
- Plat de feu baissé pour meilleure vision du feu
- Air 1<sup>er</sup> et 2<sup>e</sup> réglables avec registre unique, air tertiaire avec système de post-combustion
- Air de combustion BBC
- **Flamme Verte: Appareil de class 7★**

- Ausziehbarer Aschekasten
- Rost und Feuerraumtür aus Gusseisen G20
- Brennraum aus Nordiker-Schamott
- Austauschbarer Anschlag
- Ohne Raumlüfter
- Brennraumbasis niedriger um besser das Feuer zu sehen
- Verstellbare primär und Sekundärluft,

voraustarierte Tertiärluft mit Nachverbrennungssystem  
• Verbrennungsluft BBC

- Cajón de la ceniza extraíble
- Puerta y rejilla de hierro fundido G20
- Hogar de Nordiker
- Puerta con apertura reversible
- Sin motores de ventilación
- Base fogón mas baja para mejorar visión del fuego
- Aire primario y secundario regulable con unico registro, aire terciario precalibrado con sistema de postcombustión
- Aire comburente BBC

DATI TECNICI

800x561x509	Nordiker
147	% 83,9
626x278	2,1
652x327x350	Ø 160



CERTIFICAZIONI

**15a B-VG**  
**BlmSchV**



TECNOLOGIA

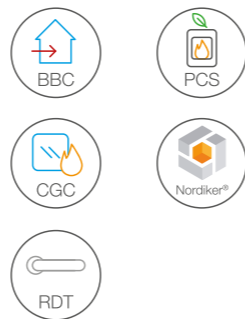

OPTIONAL



Kit "Wind Air"



Shade diffuser



Wave diffuser

# INSERTO 80 PRS WIDE

**A+** | 8,6 kW-N | 246 m<sup>3</sup>

PLUS

- Sistema Power Radiant System
- Piano fuoco ribassato per maggiore visione della fiamma
- Senza motori di ventilazione
- Apertura porta reversibile
- Griglia e porta in ghisa G20
- Focolare in Nordiker
- Cassetto cenere estraibile
- Aria 1<sup>a</sup> e 2<sup>a</sup> regolabili con unico registro, aria terziaria pretrata con sistema di post-combustione
- Possibilità di prelevare l'aria comburente dall'esterno
- Power Radiant System (PRS)
- Lowered fire top for better flame view
- Without fan motors
- Reversible door opening
- G20 cast iron grille and door
- Nordiker hearth
- Removable ash box
- Adjustable primary and secondary air with a single draft device, pre-calibrated tertiary air with post combustion system
- External air intake (BBC)

- Système Radiant
- Plan de brûlage abaissé pour une meilleure vision de la flamme
- Sans moteurs de ventilation
- Ouverture de porte réversible
- Grille et porte en fonte G20
- Foyer en Nordiker
- Tiroir à cendres extractible
- Air primaire et secondaire réglables au moyen d'un seul réglage, tandis que l'air tertiaire est pré-étalonné avec un système de postcombustion
- Possibilité de prélever l'air comburant de l'extérieur
- **Flamme Verte: Appareil de class 7★**

- Power Radiant System
- Abgesenkte Feuerfläche für eine bessere Sicht der Flamme
- Ohne Gebläsemotoren
- Öffnung mit umkehrbarer Tür
- Gitter und Tür aus Gusseisen G20
- Feuerstelle aus Nordiker
- Herausziehbarer Aschenkasten
- Verstellbare Primär und Sekundärluft mit

einem einzigen Regler, voraustarierte Tertiärluft mit Nachverbrennungssystem  
• Möglichkeit, die Verbrennungsluft von außen zuzuleiten

- Sistema Power Radiant System
- Repisa de fuego rebajado para una mejor visión de la llama
- Sin motores de ventilación
- Apertura de puerta reversible
- Rejilla y puerta de fundición G20
- Hogar de Nordiker
- Cajón para la recogida de cenizas extraíble
- Aire primario y secundario regulables con un solo registro, aire terciario precalibrado con sistema de post-combustión
- Posibilidad de captar el aire comburente del exterior

DATI TECNICI

800x912x509	Nordiker
165	% 88,2
630x290	2,3
655x310x350	Ø 160



CERTIFICAZIONI

**15a B-VG**  
**BlmSchV**



TECNOLOGIA

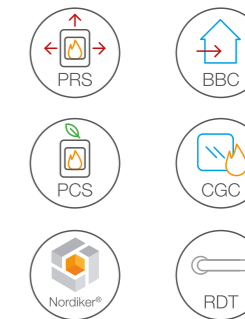

CONTO TERMICO

Per maggiori informazioni consultare il nostro sito:

www.lanordica-extraflame.com



INSERTI 



OPTIONAL



Kit "Wind Air"



Shade diffuser



Wave diffuser

## INSERTO 100 WIDE

**A+** | 8,1 kW-N | 232 m<sup>3</sup>



PLUS

- Cassetto cenere estraibile
- Griglia e porta in ghisa G20
- Focolare in Nordiker
- Apertura porta reversibile
- Senza motori di ventilazione
- Piano fuoco ribassato per maggiore visione della fiamma
- Aria 1<sup>a</sup> e 2<sup>a</sup> regolabili con unico registro, aria terziaria pretrata con sistema di post-combustione
- Possibilità di prelevare l'aria comburente dall'esterno







- Extractable ash drawer
- Cast Iron Grid and Door G20
- Nordiker Firebox
- Reversible door opening
- Without fan ventilation
- Low-floor fire plain for great flame vision
- Adjustable primary and secondary air, pre-calibrated tertiary with post combustion system
- Combustion Air BBC

- Tiroir à cendres extractible
- Grille et porte en Fonte G20
- Foyer en Nordiker
- Ouverture de porte réversible, fournie d'office à gauche
- Sans moteurs de ventilation
- Plat de feu baissé pour meilleure vision du feu
- Air 1<sup>er</sup> et 2<sup>e</sup> réglables avec registre unique, air tertiaire avec système de post-combustion
- Air de combustion BBC
- Flamme Verte: Appareil de class 7★

- Ausziehbarer Aschekasten
- Rost und Feuerraumtür aus Gusseisen G20
- Brennraum aus Nordiker-Schamott
- Austauschbarer Anschlag
- Ohne Raumlüfter
- Brennraumbasis niedriger um besser das Feuer zu sehen
- Verstellbare primär und Sekundärluft, voraustarierte Tertiärluft mit Nachverbrennungssystem
- Verbrennungsluft BBC

- Cajón de la ceniza extraíble
- Puerta y rejilla de hierro fundido G20
- Hogar de Nordiker
- Puerta con apertura reversible
- Sin motores de ventilación
- Base hogar mas baja para mejorar visión del fuego
- Aire primario y secundario regulable con unico registro, aire terciario precalibrado con sistema de postcombustión
- Aire comburente BBC

DATI TECNICI

 1000x561x509**	 Nordiker
 178	% 81
 826x278	 2,3
 856x327x350	∅ 160



CERTIFICAZIONI

15a B-VG

BImSchV



TECNOLOGIA



FOCOLARI 



Modello completo di carter di ventilazione (optional)  
Model complete with ventilation covering (Optional)  
Modèle complet de revêtement de ventilation (Optionnel)  
Model mit Lüftungsverkleidung (Extra, Optional)  
Modelo equipado de cárter de ventilación (opcional).

## FOCOLARE 60 PIANO EVO

**A+** | 8,5 kW-N | 243 m<sup>3</sup>

PLUS

- Costruito interamente in ghisa G20 radiante
- Cassetto cenere estraibile
- Ghisa da 8 e 16 mm
- Vetro ceramico resistente fino a 750°
- Possibilità di prendere dall'esterno l'aria comburente
- Aria primaria e secondaria regolabile, aria terziaria pretrata con sistema di post combustione
- Ventilazione opzionale tramite accessori optional (Carter + Kit ventilazione o Kit Wind Air)

- Completely built in radiant g20 cast iron
- Extractable ash drawer
- Cast iron of 8 and 16mm
- Ceramic glass heat-resistant 750°C
- Possibility to take from outside the combustive air
- Adjustable primary and secondary air, preset tertiary air with post combustion system
- Ventilation and related accessories

optional (Carter + Kit ventilation or Kit Wind Air)







- Construit entièrement en fonte G20 radiante
- Tiroir pour cendres extractible
- Fonte de 8 à 16 mm
- Vitre céramique résistant jusqu'à 750°
- Possibilité de prendre l'air comburant de l'extérieur
- Air primaire et secondaire réglables, air tertiaire pré-calibré avec système post combustion
- Ventilation optionnelle avec accessoires optionnels (Carter + Kit ventilation ou Kit Wind Air)
- Flamme Verte: Appareil de class 7★

- Ganz aus strahlendem Gusseisen G20 gebaut
- Ausziehbarer Aschenbehälter
- Gusseisen, Stärke 8 und 16 mm
- Glaskeramikfenster, hitzebeständig bis

auf 750°

- Möglichkeit, die Verbrennungsluft von außen zuzuleiten
- Verstellbare Primär und Sekundärluft, voraustarierte Tertiärluft mit Nachverbrennungssystem
- Ventilation optional (Gehäuse+ Belüftungsbausatz oder Kit Wind Air)
- Fabricado completamente con hierro fundido G20 radiante
- Cenicero extraíble
- Hierro fundido de 8 y 16 mm
- Cristal cerámico resistente hasta 750°C
- Posibilidad de captar el aire comburente desde el exterior
- Aire primaria y secundaria regulable, aire terciaria con sistema de postcombustion precalibrado
- Ventilación opcional a través de accesorios (Carter + Kit de ventilación o Kit "Wind Air")

DATI TECNICI

 609x985-1085x467	 Ghisa
 136	% 85,1
 380x255	 2,3
 350x280x285	∅ 160



CERTIFICAZIONI

15a B-VG

BImSchV



TECNOLOGIA



AES-P-076  
certificazioneariaPulita.it



CONTO TERMICO

Per maggiori informazioni consultare il nostro sito:

www.lanordica-extraflame.com



Power Radiant System



Modello completo di carter di ventilazione (optional)  
Model complete with ventilation covering (Optional)  
Modèle complet de revêtement de ventilation (Optionnel)  
Model mit Lüftungsverkleidung (Extra, Optional)  
Modelo equipado de carter de ventilación (opcional).

# FOCOLARE 70 PIANO EVO CRYSTAL

**A+** | 9,0 kW-N | 258 m<sup>3</sup>

## PLUS

- Sistema Power Radiant System
- Cassetto cenere estraibile frontalmente
- Costruito interamente in ghisa G20 radiante ad alto spessore
- Focolare in ghisa-Nordiker
- Possibilità di prendere dall'esterno l'aria secondaria
- Ventilazione opzionale tramite accessori optional (Carter + Kit ventilazione o Kit Wind Air)
- Power Radiant System
- Front extractable ash drawer
- Entirely built with radiant G20 cast iron
- Cast iron and Nordiker Firebox
- External air intake
- Ventilation and related accessories







optional (Carter + Kit ventilation or Kit Wind Air)

- Système Radiant
- Tiroir à cendres à extraire en facade
- Produit entièrement en fonte G20
- Foyer en Fonte et Nordiker
- Air secondaire raccordable à l'extérieur
- Ventilation optionnelle avec accessoires optionnels (Carter + Kit ventilation ou Kit Wind Air)
- **Flamme Verte: Appareil de class 7★**

- Power Radiant System
- Frontal ausziehbarer Aschekasten
- Komplet aus hochdichtem G20 Gusseisen



## DATI TECNICI

 704x1125-1225x491	 Ghisa-Nordiker
 172	% 85,3
 480x288	 2,5
 450x315x350	∅ 200



## CERTIFICAZIONI

**15a B-VG**

**BlmSchV**



## TECNOLOGIA



# FOCOLARE 70 PIANO

**A** | 9,1 kW-N | 261 m<sup>3</sup>

## PLUS

- Costruito interamente in ghisa G20 radiante
- Cassetto cenere estraibile
- Ghisa da 8 e 16 mm
- Vetro ceramico resistente fino a 750°
- Possibilità di prendere dall'esterno l'aria comburente
- Aria primaria e secondaria regolabile, aria terziaria pretrata con sistema di post combustione
- Ventilazione opzionale tramite accessori optional (Carter + Kit ventilazione o Kit Wind Air)
- Completely built in radiant g20 cast iron
- Extractable ash drawer
- Cast iron of 8 and 16mm
- Ceramic glass heat-resistant 750°C
- Possibility to take from outside the combustive air
- Adjustable primary and secondary air, preset tertiary air with post combustion system
- Ventilation and related accessories

optional (Carter + Kit ventilation or Kit Wind Air)







- Construit entièrement en fonte G20 radiante
- Tiroir pour cendres extractible
- Fonte de 8 à 16 mm
- Vitre céramique résistant jusqu'à 750°
- Possibilité de prendre l'air comburant de l'extérieur
- Air primaire et secondaire réglables, air tertiaire pré-calibré avec système post combustion
- Ventilation optionnelle avec accessoires optionnels (Carter + Kit ventilation ou Kit Wind Air)

- Ganz aus strahlendem Gusseisen G20 gebaut
- Ausziehbarer Aschenbehälter
- Gusseisen, Stärke 8 und 16 mm
- Glaskeramikfenster, hitzebeständig bis auf 750°

- Möglichkeit, die Verbrennungsluft von außen zuzuleiten
- Verstellbare Primär und Sekundärluft, voraustrierte Tertiärluft mit Nachverbrennungssystem
- Ventilation optional (Gehäuse+ Belüftungsbausatz oder Kit Wind Air)

- Fabricado completamente con hierro fundido G20 radiante
- Cenicero extraible
- Hierro fundido de 8 y 16 mm
- Cristal cerámico resistente hasta 750°C
- Posibilidad de captar el aire comburente desde el exterior
- Aire primaria y secundaria regulable, aire terciaria con sistema de postcombustion precalibrado
- Ventilación opcional a través de accesorios (Carter + Kit de ventilación o Kit "Wind Air")

## DATI TECNICI

 693x1025-1125x491	 Ghisa
 142	% 80
 565x320	 2,7
 520x404x360	∅ 200



## CERTIFICAZIONI

**15a B-VG**

**BlmSchV**

## TECNOLOGIA





Doppia apertura porta, a libro e a saliscendi  
 Double door opening, folding and vertical  
 Une porte escamotable et une porte avec ouverture à battante  
 Doppeltür: eine vertikal schliessende Tür + eine Tür mit Öffnung rechts/links  
 Una puerta con abertura picaporte y la otra a libro



Modello completo di carter di ventilazione.  
 Model complete with ventilation covering.  
 Modèle complet de revêtement de ventilation.  
 Model mit Lüftungsverkleidung.  
 Modelo equipado de cárter de ventilación.

## FOCOLARE 80 BIFACCIALE HYBRID







**A+** | 10,2 kW-N | 292 m<sup>3</sup>



### PLUS

- Porta con apertura saliscendi e una con apertura a libro
- Piano fuoco e griglia in ghisa G20 di grosso spessore
- Elementi superiori focolare in Nordiker
- Cappa in ghisa
- Carter di convezione in acciaio zincato
- Vetro ceramico resistente fino a 750°
- Cassetto cenere estraibile
- Aria primaria e secondaria regolabile
- Ventilazione opzionale tramite accessori optional (Kit ventilazione o Kit Wind Air)
- One latch door, one door with 90°c opening
- Fire plan and grid in thick g20 cast iron
- Hearth top elements in Nordiker
- Cast iron cape
- Convection carter in galvanized steel
- Ceramic glass heat-resistant 750°C
- Extractable ash drawer
- Adjustable primary and secondary air
- Ventilation and related accessories optional (Kit ventilation or Kit Wind Air)
- Porte avec ouverture à guillotine et une avec ouverture latérale
- Plancher foyer et grille en fonte G20 de grosse épaisseur
- Éléments supérieurs foyer en Nordiker
- Hotte en fonte
- Carter de convection en acier galvanisé
- Vitre céramique résistant jusqu'à 750°
- Tiroir pour cendres extractible
- Air primaire et secondaire réglables
- Ventilation optionnelle avec accessoires optionnels (Kit ventilation ou Kit Wind Air)
- **Flamme Verte: Appareil de class 7★**
- Eine Tür mit Auf- und Abbewegung zum Öffnen und eine mit Faltöffnung
- Feuerfläche und Rost aus sehr starkem Gusseisen G20
- Obere Teile der Feuerstelle aus Nordiker
- Rauchabzug aus Gusseisen
- Konvektionsgehäuse aus verzinktem Stahl
- Glaskeramikfenster, hitzebeständig bis auf 750°
- Ausziehbarer Aschenbehälter
- Verstellbare Primär und Sekundärluft
- Ventilation optional (Belüftungsbausatz oder Kit Wind Air)
- Puerta con apertura de pestillo y otra plegable
- Repisa de fuego y rejilla de hierro fundido G20 de gran grosor
- Elementos superiores del hogar de Nordiker
- Campana de hierro fundido
- Cáster de convección de acero galvanizado
- Cristal cerámico resistente hasta 750°C
- Cenicero extraíble
- Aire primaria y secundaria regulable
- Ventilación opcional a través de accesorios (Kit de ventilación o Kit "Wind Air")

### DATI TECNICI

 936x1560x699	 Ghisa - Nordiker
 295	% 83
 633x225	 2,5
 635x285x500	∅ 200

### CERTIFICAZIONI

**15a B-VG**  
**BlmSchV**  

### TECNOLOGIA

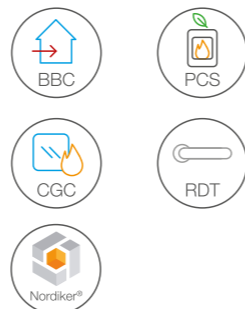

Parte superiore interamente in ghisa di grosso spessore  
 Upper part completely made of very thick cast-iron  
 Partie supérieure complètement en fonte de gros épaisseur  
 Oberer Teil völlig aus dicken Gusseisen  
 Lado superior completamente hecho de hierro fundido de grande espesor



Apertura con doppia porta  
 Opening with double door  
 Ouverture avec double porte  
 Öffnung mit Doppeltür  
 Dos puertas para abrir

Cassetto cenere estraibile  
 Extractable ash drawer  
 Tiroir cendrier extractible  
 Ausziehbarer Aschenkasten  
 Cenicero extraíble

## FOCOLARE 100 BIFACCIALE







**A** | 11,0 kW-N | 315 m<sup>3</sup>



### PLUS

- Doppia porta con apertura a libro
- Piano fuoco e griglia in ghisa G20 di grosso spessore
- Elementi superiori focolare in Nordiker
- Cappa in ghisa
- Carter di convezione in acciaio zincato
- Vetro ceramico resistente fino a 750°
- Cassetto cenere estraibile
- Aria primaria e secondaria regolabile
- Ventilazione opzionale tramite accessori optional (Kit ventilazione o Kit Wind Air)
- 90°c opening double door
- Fire plan and grid in thick g20 cast iron
- Hearth top elements in Nordiker
- Cast iron cape
- Convection carter in galvanized steel
- Ceramic glass heat-resistant 750°C
- Extractable ash drawer
- Adjustable primary and secondary air
- Ventilation and related accessories optional (Kit ventilation or Kit Wind Air)
- Double porte à deux vantaux
- Plancher foyer et grille en fonte G20 de grosse épaisseur
- Éléments supérieurs foyer en Nordiker
- Hotte en fonte
- Carter de convection en acier galvanisé
- Vitre céramique résistant jusqu'à 750°
- Tiroir pour cendres extractible
- Air primaire et secondaire réglables
- Ventilation optionnelle avec accessoires optionnels (Kit ventilation ou Kit Wind Air)
- **Flamme Verte: Appareil de class 7★**
- Doppelte Tür mit standardmäßigem Öffnungsmechanismus
- Feuerfläche und Rost aus sehr starkem Gusseisen G20
- Obere Teile der Feuerstelle aus Nordiker
- Rauchabzug aus Gusseisen
- Konvektionsgehäuse aus verzinktem Stahl
- Glaskeramikfenster, hitzebeständig bis auf 750°
- Ausziehbarer Aschenbehälter
- Verstellbare Primär und Sekundärluft
- Ventilation optional (Belüftungsbausatz oder Kit Wind Air)
- Puerta doble plegable
- Repisa de fuego y rejilla de hierro fundido G20 de gran grosor
- Elementos superiores del hogar de Nordiker
- Campana de hierro fundido
- Cáster de convección de acero galvanizado
- Cristal cerámico resistente hasta 750°C
- Cenicero extraíble
- Aire primaria y secundaria regulable
- Ventilación opcional a través de accesorios (Kit de ventilación o Kit "Wind Air")

### DATI TECNICI

 1104x1406x675	 Ghisa - Nordiker
 267	% 80
 833x227	 3,3
 835x285x500	∅ 200

### CERTIFICAZIONI

**15a B-VG**  

### TECNOLOGIA

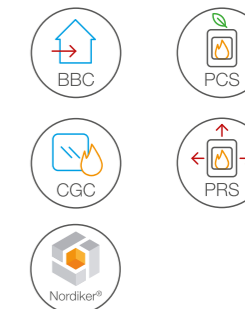



800 Angolo SX



800 Angolo DX



Porta a scomparsa totale scorrevole su binari silenziosi  
 Vanishing and sliding door on silent telescopic slides  
 Porte à totale coulisse sur glissières silencieux  
 Komplette Verschwindung der Schiebetür auf geräuschgedämpften Teleskopführungen  
 Puerta escamoteable total que se desliza sobre rieles silenciosos.

# MONOBLOCCO 800 ANGOLO SX MONOBLOCCO 800 ANGOLO DX

**A+** | 10,0 kW-N | 287 m<sup>3</sup>

## PLUS

- Piano fuoco e griglia in ghisa G20 di grosso spessore
- Elementi superiori focolare in Nordiker
- Cappa in acciaio speciale spess. 3 mm
- Vetro ceramico resistente a 750° C in pezzo unico
- Aria primaria e secondaria regolabile, aria terziaria pretrata con sistema di post combustione
- Cassetto cenere estraibile
- Ventilazione opzionale

- Fire plan and grid in thick G20 cast iron
- Hearth top elements in Nordiker
- 3 mm thick special steel cape
- Ceramic glass heat-resistant 750°c in a single piece
- Adjustable primary and secondary air, preset tertiary air with post combustion system

- Extractable ash drawer
- Ventilation optional

- Plancher foyer et grille en fonte G20 de grosse épaisseur
- Éléments supérieurs foyer en Nordiker
- Hotte en acier épaisseur spéciale 3 mm
- Vitre céramique résistant à 750° C en une seule pièce
- Air primaire et secondaire réglables, air tertiaire pré-calibré avec système post combustion
- Tiroir pour cendres extractible
- Ventilation optionnelle
- Flamme Verte: Appareil de class 7★

- Feuerfläche und Rost aus sehr starkem Gusseisen G20
- Obere Teile der Feuerstelle aus Nordiker
- Rauchabzug aus Spezialstahl, Stärke 3 mm

- Glaskeramikfenster, hitzebeständig bis auf 750°C, an einem Stück
- Verstellbare Primär und Sekundärluft, voraustarierte Tertiärluft mit Nachverbrennungssystem
- Ausziehbarer Aschenbehälter
- Ventilation Set optional

- Repisa de fuego y rejilla de hierro fundido G20 de gran grosor
- Elementos superiores del hogar de Nordiker
- Campana de acero especial de 3 mm de grosor
- Cristal cerámico resistente hasta 750° C en un bloque único
- Aire primaria y secundaria regulable, aire terciaria con sistema de postcombustion precalibrado
- Cenicero extraíble
- Ventilación opcional

## DATI TECNICI

879x1570-1605x612	Ghisa - Nordiker
271	% 80,9
698x250	2,9
620x676x373	200



## CERTIFICAZIONI

**15a B-VG**

**BlmSchV**



## TECNOLOGIA



# MONOBLOCCO GHISA 750 - PIANO

**A** | 13,0 kW-N | 373 m<sup>3</sup>

## PLUS

- Piano fuoco e griglia in ghisa G20 di grosso spessore
- Focolare in ghisa
- Cappa in ghisa
- Vetro ceramico resistente a 750° C in pezzo unico
- Aria primaria e secondaria regolabile, aria terziaria pretrata con sistema di post combustione
- Cassetto cenere estraibile
- Ventilazione opzionale

- Fire plan and grid in thick g20 cast iron
- Cast iron hearth
- Cast iron cape
- Ceramic glass heat-resistant 750°c in a single piece
- Adjustable primary and secondary air, preset tertiary air with post combustion system

- Extractable ash drawer
- Ventilation optional

- Plancher foyer et grille en fonte G20 de grosse épaisseur
- Foyer en fonte
- Hotte en fonte
- Vitre céramique résistant à 750° C en une seule pièce
- Air primaire et secondaire réglables, air tertiaire pré-calibré avec système post combustion
- Tiroir pour cendres extractible
- Ventilation optionnelle
- Flamme Verte: Appareil de class 7★

- Feuerfläche und Rost aus sehr starkem Gusseisen G20
- Feuerstelle aus Gusseisen
- Rauchabzug aus Gusseisen

- Glaskeramikfenster, hitzebeständig bis auf 750°C, an einem Stück
- Verstellbare Primär und Sekundärluft, voraustarierte Tertiärluft mit Nachverbrennungssystem
- Ausziehbarer Aschenbehälter
- Ventilation Set optional

- Repisa de fuego y rejilla de hierro fundido G20 de gran grosor
- Hogar de hierro fundido
- Campana de hierro fundido
- Cristal cerámico resistente hasta 750° C en un bloque único
- Aire primaria y secundaria regulable, aire terciaria con sistema de postcombustion precalibrado
- Cenicero extraíble
- Ventilación opcional

Porta a scomparsa totale scorrevole su binari silenziosi  
 Vanishing and sliding door on silent telescopic slides  
 Porte à totale coulisse sur glissières silencieux  
 Komplette Verschwindung der Schiebetür auf geräuschgedämpften Teleskopführungen  
 Puerta escamoteable total que se desliza sobre rieles silenciosos



Aria primaria, secondaria e terziaria  
 Primary, secondary and tertiary air  
 Air primaire, secondaire et tertiaire  
 Primär-, Sekundär- und Tertiärluft  
 Aire primario, secundario y terciario



## DATI TECNICI

846x1624-1664x678	Ghisa
342	% 78,3
650x390	3,8
630x550x430	200



## CERTIFICAZIONI

**BlmSchV**



## TECNOLOGIA





Cassetto cenere estraibile  
Extractable ash drawer  
Tiroir cendrier extractible  
Ausziehbarer Aschenkasten  
Cenicero extraible



Interno Nordiker con braciere in ghisa di grosso spessore  
Inner Nordiker with brazier in thick cast-iron  
Intérieur Nordiker avec brasero en fonte de gros épaisseur  
Innenraum Nordiker mit Brennschale aus dickem Gusseisen  
Interior Nordiker con brasero en fundición de grueso espesor



# MONOBLOCCO GHISA 750 - IRONKER PIANO

**A** | 13,0 kW-N | 373 m<sup>3</sup>



## PLUS

- Piano fuoco e griglia in ghisa G20 di grosso spessore
- Elementi superiori focolare in Nordiker
- Cappa in acciaio speciale spess. 3 mm
- Vetro ceramico resistente a 750° C in pezzo unico
- Aria primaria e secondaria regolabile, aria terziaria pretrata con sistema di post combustione
- Cassetto cenere estraibile
- Ventilazione opzionale

- Fire plan and grid in thick g20 cast iron
- Hearth top elements in Nordiker
- 3 mm thick special steel cape
- Ceramic glass heat-resistant 750°C in a single piece
- Adjustable primary and secondary air, preset tertiary air with post combustion system
- Extractable ash drawer
- Ventilation optional







- Plancher foyer et grille en fonte G20 de grosse épaisseur
- Éléments supérieurs foyer en Nordiker
- Hotte en acier épaisseur spéciale 3 mm
- Vitre céramique résistant à 750° C en une seule pièce
- Air primaire et secondaire réglables, air tertiaire pré-calibré avec système post combustion
- Tiroir pour cendres extractible
- Ventilation optionnelle
- Flamme Verte: Appareil de class 7★

- Feuerfläche und Rost aus sehr starkem Gusseisen G20
- Obere Teile der Feuerstelle aus Nordiker
- Rauchabzug aus Spezialstahl, Stärke 3 mm
- Glaskeramikfenster, hitzebeständig bis auf 750°C, an einem Stück
- Verstellbare Primär und Sekundärluft, voraustrarierte Tertiärluft mit

- Nachverbrennungssystem
- Ausziehbarer Aschenbehälter
- Ventilation Set optional

- Repisa de fuego y rejilla de hierro fundido G20 de gran grosor
- Elementos superiores del hogar de Nordiker
- Campana de acero especial de 3 mm de grosor
- Cristal cerámico resistente hasta 750° C en un bloque único
- Aire primaria y secundaria regulable, aire terciaria con sistema de postcombustion precalibrado
- Cenicero extraible
- Ventilación opcional

## DATI TECNICI

 846x1624-1664x678	 Ghisa - Nordiker
 336	% 78,3
 650x390	 3,8
 630x550x430	∅ 200



## CERTIFICAZIONI



## TECNOLOGIA

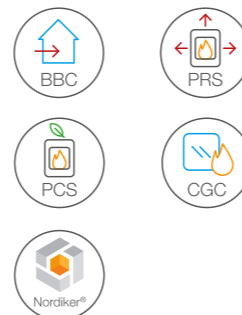

## RIVESTIMENTI E CORNICI

Frames and Coatings  
Cadres et Revêtements  
Rahmen und Verkleidungen  
Marcos y Revestimientos





## ARNO

Rivestimento in marmo Silva Oro levigato e Wengè spazzolato e trattato.

Molding in polished Silva Oro marble and brushed and treated Wengè marble.

Revêtement en marbre Silva Oro poli et Wengè brossé et traité.

Verkleidung aus geschliffenem Silva Oro Marmor und aus gebürstetem, behandeltem Wengé.

Revestimiento de mármol silva oro pulido y wenge pulido y tratado.



## ASTICO

Rivestimento con rialzo in marmo Giallo d'Istria, base e trave in marmo Ebano lucido, spalle in marmo Giallo d'Istria anticato.

Molding with wedge in Giallo d'Istria marble, base and girder in polished Ebano marble, abutment in antique Giallo d'Istria marble.

Revêtement avec dossier en marbre Jaune d'Istrie, base et poutre en marbre Ébène brillant, épaules en marbre Jaune d'Istrie antique.

Verkleidung und Aufsatz aus gelbem Marmor aus Istrien, Sockel und Träger aus poliertem Ebenholz, Seitenteile aus antikisiertem, gelbem Marmor aus Istrien.

Revestimiento con realce de mármol amarillo de Istria, base y viga de mármol ébano pulido, bastidores de mármol amarillo de istria envejecido.

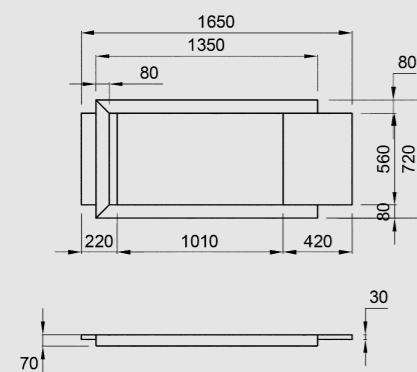

**Allestimento per - Setting with - Préparation d' Vorbereitung für - Preparación para**

Inserto 100 Crystal - Ventilato  
Focolare 100 Bifacciale

page 163  
page 175

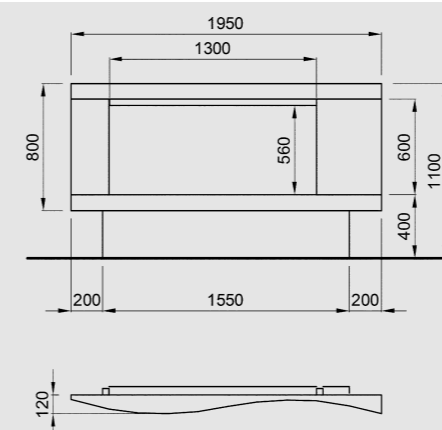

**Allestimento per - Setting with - Préparation d' Vorbereitung für - Preparación para**

Monoblocco 1300 - Piano Crystal



## ANIENE

Rivestimento con spalle e rialzo in marmo Rosso Verona tranciato senza fughe, spalle in marmo Trani bocciardato, base in marmo Silva Oro.

Molding with abutment and wedge in veneer without leaks marmo Rosso Verona, abutment bush-hammered in Trani marble, base in Silva Oro marble.

Revêtement avec épaules et dossier en marbre Rouge Vérone tranché sans fuites, épaules en marbre Trani bouchardé, base en marbre Silva Oro.

Verkleidung mit Seitenteilen und Aufsatz aus rotem Marmor aus Verona, aus einem Stück gehauen, Seitenteile aus aufgerautem Marmor aus Trani, Sockel aus Silva Oro Marmor.

Revestimiento con bastidores y realce de mármol rojo verona troquelado sin juntas, bastidores de mármol trani abujardado, base de mármol silva oro.



## LINEAR

L'ampia cornice è in marmo Travertino Classico. Gli elementi trasversali sono in marmo Rosso Verona.

The large frame is made of Classic Travertine marble. Cross components are made of Red Verona marble.

Le vaste cadre est en marbre Travertin Classique. Les éléments transversaux sont en marbre Rouge Vérone.

Der breite Rahmen ist aus klassischem Travertinestein. Die Querelemente sind aus rotem Marmor aus Verona.

El amplio marco es de mármol travertino clásico. los elementos transversales son de mármol rojo verona.

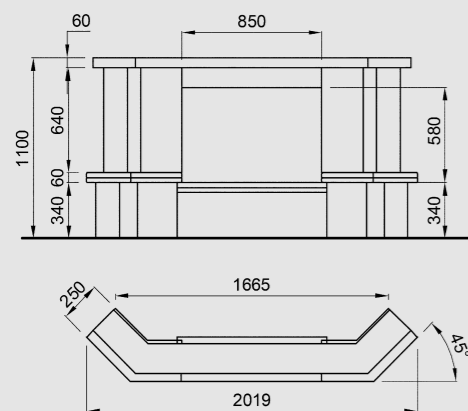

**Allestimento per - Setting with - Préparation d' Vorbereitung für - Preparación para**

TermoCamino 800 - Piano

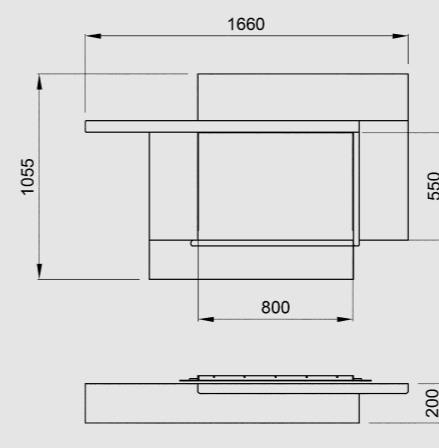

**Allestimento per - Setting with - Préparation d' Vorbereitung für - Preparación para**

Inserto 80 Crystal Evo 2.0 - Ventilato page 159  
 Inserto 80 High Pressure page 160  
 Inserto 80 PRS Crystal - Ventilato page 162  
 Focolare 80 Bifacciale Hybrid page 174  
 Focolare 80 Idro Crystal DSA page 232





## ASIAGO

Cornice in marmo Biancone di Asiago e Verde India

Frame made of Asiago Biancone and Verde India.

Cadre en marbre Blanc d'Asiago et Vert Inde

Rahmen aus Biancone Asiago und Verde India.

Marco de mármol Biancone de Asiago y Verde India



## CORNICE MAIOLICA

Cornice in fine maiolica colore Oro Craquelé / Cornice in fine maiolica colore Madreperla.

Fine gold craquelure majolica surround / Fine mother-of-pearl majolica surround.

Cadre en céramique couleur oro craquelé / Cadre en céramique couleur Madreperla.

Rahmen aus feiner Majolika, Farbe Gold craquelé / Rahmen aus feiner Majolika, Farbe Perlmutt.

Marco de elegante mayólica de color oro resquebrajado / Marco de elegante mayólica de color nacarado.

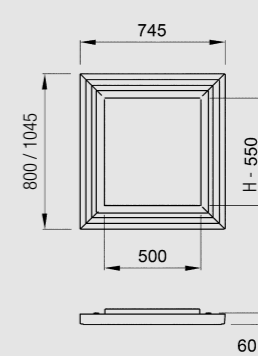

H - 550 / 795 mm

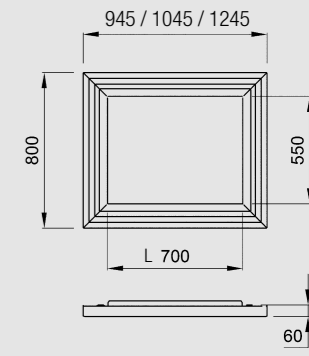

L - 700 - 800 - 1000 mm

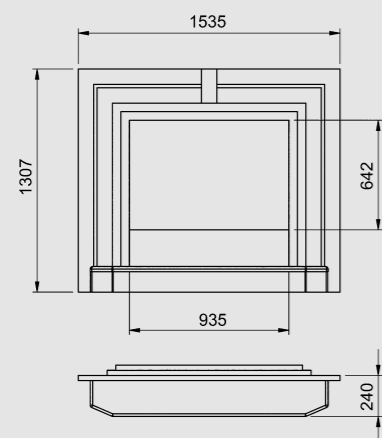

**Allestimento per - Setting with - Préparation d' / Vorbereitung für - Preparación para**

Monoblocco Ghisa 750 - Ironker Piano page 178  
Monoblocco Ghisa 750 - Piano page 177

**Allestimento per - Setting with - Préparation d' - Vorbereitung für - Preparación para**

**ORO CRAQUELÉ 50V  
MADREPERLA 50V**

Inserto 50 Vert. Crystal BII - Vent. page 157

**ORO CRAQUELÉ 70  
MADREPERLA 70**

Inserto 70 Crystal - Ventilato page 158

**ORO CRAQUELÉ 80  
MADREPERLA 80**

Inserto 80 Crystal Evo 2.0 - Ventilato page 159  
Inserto 80 High Pressure page 160  
Inserto 80 PRS Crystal - Ventilato page 162  
Focolare 80 Bifacciale Hybrid  
(solo lato porta con apertura a libro) page 174  
Focolare 80 Idro Crystal DSA page 232

**ORO CRAQUELÉ 100  
MADREPERLA 100**

Inserto 100 Crystal - Ventilato page 163  
Focolare 100 Bifacciale page 175



## CORNICE ORIGAMI

Cornice in maiolica frastagliata Bianco Infinity

Surrounding in Infinity White uneven majolica finish.

Cadre en faïence rugueuse Blanc Infinity

Rahmen aus Majolika mit gezacktem Rand, Bianco Infinity

Marco de mayólica irregular blanco infinity



## CORNICE STEEL

Cornice in acciaio verniciato antracite. Il design pulito e minimalista dallo stile moderno, esalta la visione del fuoco.

Surrounding in Anthracite printed steel finish. The clean and minimalist modern design emphasizes the vision of fire.

Cadre en acier verni anthracite. Le design propre et minimaliste du style moderne exalte la vision du feu.

Rahmen aus lackiertem Stahl Anthrazit. Das saubere und minimalistische Design in modernem Stil hebt die Ansicht des Feuers hervor.

Marco de acero esmaltado antracita. El diseño puro y minimalista de estilo moderno, exalta la visión del fuego.

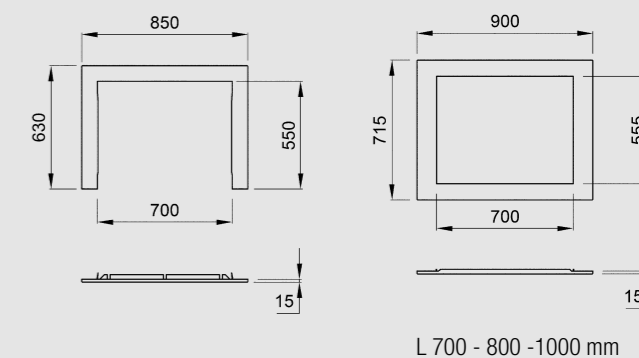

L 700 - 800 - 1000 mm

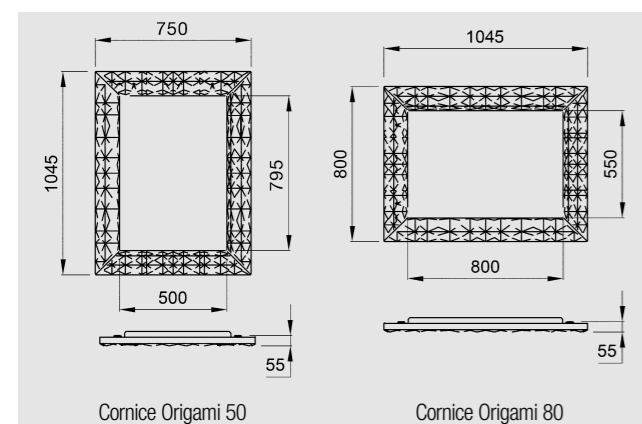

Cornice Origami 50

Cornice Origami 80

**Allestimento per - Setting with - Préparation d' - Vorbereitung für - Preparación para**

### CORNICE ORIGAMI 50 BIANCO INFINITY

Inserto 50 Vert. Crystal BII - Vent. page 157

### CORNICE ORIGAMI 80 BIANCO INFINITY

Inserto 80 Crystal Evo 2.0 - Ventilato page 159  
Inserto 80 High Pressure page 160  
Inserto 80 PRS Crystal - Ventilato page 162

**Allestimento per - Setting with - Préparation d' - Vorbereitung für - Preparación para**

### CORNICE STEEL 3 LATI

Inserto 70 - Ventilato page 150  
Inserto 70 4.0 - Ventilato page 151  
Inserto 70 H49 - Ventilato page 153  
Inserto 70 H49 4.0 - Ventilato page 154  
Inserto 70 L - Ventilato page 155  
Inserto 70 L 4.0 - Ventilato page 156

### CORNICE STEEL 70

Inserto 70 Crystal - Ventilato page 158

### CORNICE STEEL 80

Inserto 80 Crystal Evo 2.0 - Ventilato page 159  
Inserto 80 High Pressure page 160  
Inserto 80 PRS Crystal - Ventilato page 162  
Focolare 80 Bifacciale Hybrid page 174  
(solo lato porta apertura a libro)  
Focolare 80 Idro Crystal DSA page 226

### CORNICE STEEL 100

Inserto 100 Crystal - Ventilato page 163  
Focolare 100 Bifacciale page 175



## CORNICE WENDY\*

Elementi laterali in maiolica bordeaux, elementi centrali in cristallo nero.

Side elements in burgundy majolica, central elements in black glass.

Éléments latéraux en céramique bordeaux, éléments centraux en cristal noir.

Seitenelemente aus Majolika Bordeaux, mittlere Elemente aus schwarzem Kristall.

Elementos laterales de mayólica color burdeos, elementos centrales de cristal negro.



## CORNICE INOX

Cornice in acciaio inox satinato.

Brushed stainless steel frame.

Cadre en acier inoxydable satiné.

Verkleidung aus satiniertem Stahl.

Marco de acero inoxidable satinado.

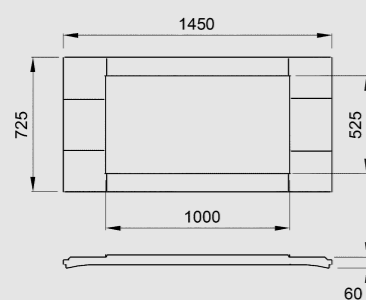

**Allestimento per - Setting with - Préparation d'**  
**Vorbereitung für - Preparación para**

### CORNICE WENDY 100\*

Inserto 100 Crystal - Ventilato  
Focolare 100 Bifacciale

page 163  
page 175

\* Fino ad esaurimento scorte - while stocks last - Jusqu'à épuisement des stocks -  
Solange der Vorrat reicht - Hasta agotamiento stocks

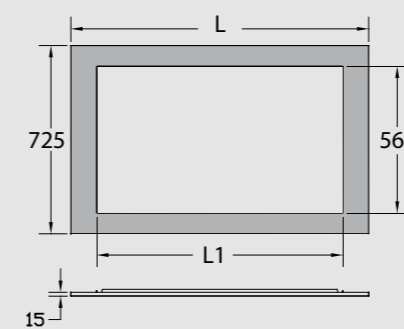

**CORNICE INOX 70**  
L=850 L1=650

**CORNICE INOX 80**  
L=950 L1=750

**CORNICE INOX 100**  
L=1150 L1=950

**Allestimento per - Setting with - Préparation d'**  
**Vorbereitung für - Preparación para**

### CORNICE INOX 70

Inserto 70 Wide  
Inserto 70 PRS Wide

page 166  
page 167

### CORNICE INOX 80

Inserto 80 Wide  
Inserto 80 PRS Wide

page 168  
page 169

### CORNICE INOX 100

Inserto 100 Wide

page 170

## SERIE TERMOSTUFE

Le termostufe “La Nordica”, progettate e realizzate con le più avanzate tecnologie, riscaldano tutta la casa con una ottima resa calorica un consumo contenuto di legna e nel completo rispetto dell’ambiente.

### THERMOPRODUCT SERIES:

“La Nordica” thermostoves designed and produced using the most advanced technologies heat the whole home with excellent heat output, low wood consumption and total respect for the environment.

### SÉRIE APPAREILS DE CHAUFFAGE:

Les thermopoêles de chauffage “La Nordica” conçus et réalisés avec les technologies les plus modernes chauffent toute la maison avec un très bon rendement calorifique, une consommation réduite de bois et dans le respect total de l’environnement.

### SERIE THERMOPRO DUKTE:

Die mit den fortschrittlichsten Technologien entwickelten und hergestellten “La Nordica” Wasserführende Holzöfen versorgen das ganze Haus mit einer optimalen Wärmezufuhr, bei eingeschränktem Holzverbrauch und mit vollkommener Rücksicht auf die Umwelt.

### SERIE TERMOPRODUCTOS:

Las termoestufas “La Nordica” han sido proyectadas y realizadas con tecnologías de calefacción de vanguardia y calientan toda la casa con un excelente rendimiento calórico, un bajo consumo de leña y dentro del más absoluto respeto por el medioambiente.



La presenza di un circuito anticondensa è un elemento obbligatorio per avere la garanzia di fabbrica sui TermoProdotti.

The presence of the anti-condensation valve is an essential element for the factory warranty on the product.

La présence de la vanne anti-condensation est un élément dont il faut tenir compte pour avoir la garantie de fabrique sur le produit.

Die Anwesenheit eines Antikondenswasserventils ist ein unumgängliches Element, um die Werksgarantie des Produkts zu erlangen.

La presencia de la válvula anticondensación es un elemento imprescindible para tener la garantía de fábrica del producto.

# TERMONATHALIE DSA

**A+** | 8,7 kW-N | 5,7 kW-H<sub>2</sub>O | 249 m<sup>3</sup>



CONTO TERMICO

Per maggiori informazioni consultare il nostro sito:

www.lanordica-extraflame.com

## PLUS

- Rivestimento esterno in maiolica.
  - Porta, testata e basamento in ghisa smaltata.
  - Cassetto portalegna estraibile.
  - Aria primaria e secondaria regolabile, aria terziaria pretrata con sistema di post combustione.
  - Dispositivo di sicurezza DSA (valvola DSA optional).
  - Vetro ceramico resistente fino a 750° C.
- External facing in majolica.
  - Enameled cast iron top, door and base.
  - Extractable wood drawer.
  - Adjustable primary and secondary air, preset tertiary air with post combustion system .
  - DSA security device (DSA valve not included).
  - Ceramic glass resistant up to 750° C.
- Revêtement extérieur en faïence.
  - Porte, élément supérieur et bâti en fonte émaillée.
  - Tiroir à bois amovible.
  - Air primaire et secondaire réglables, air tertiaire pré-calibré avec système post combustion.
  - Dispositif de sécurité DSA (soupape DSA optionnelle).
  - Vitre céramique résistante à 750° C.
  - Flamme Verte: Appareil de class 7★
- Äußere Verkleidung aus Majolika.
  - Tür, Kopf und Sockel aus emailliertem Gusseisen.
  - Herausziehbare Holzschublade.
  - Verstellbare primär und Sekundärluft, voraustarierte Tertiärluft mit Nachverbrennungssystem.
  - Sicherheitsvorrichtung DSA (DSA Sicherheitsventil OPTIONAL).
  - Keramikglas bis 750° C wärmebeständig.
- Revestimiento exterior de mayólica.
  - Puerta, cabecera y base de fundición.
  - Cajón extraíble por la leña.
  - Aire primaria y secundaria regulable, aire terciaria con sistema de postcombustión precalibrado.
  - Dispositivo de seguridad DSA (válvula DSA opcional).
  - Cristal cerámico resistente hasta 750° C.

TERMO PRODOTTI



## DATI TECNICI

559x915x538	% 88,6
165	2,3
247x245	130 S
226x226x321	18,5 L
Ghisa-Nordiker	bar 3



## CERTIFICAZIONI

15a B-VG

BlmSchV



## TECNOLOGIA

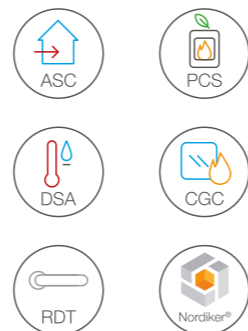



LIBERTY BORDEAUX

# TERMOROSSELLA PLUS EVO DSA

**A+** | 12,8 kW-N | 8,5 kW-H<sub>2</sub>O | 366 m<sup>3</sup>



## PLUS

- Rivestimento esterno in maiolica o pietra naturale.
- Porta, testata e basamento in ghisa smaltata.
- Cassetto porta legna estraibile.
- Aria primaria e secondaria regolabile, aria terziaria pretrata con sistema di post combustione.
- Dispositivo di sicurezza DSA (valvola DSA optional).
- Vetro ceramico resistente fino a 750° C.
- External facing in majolica or in natural stone.
- Enamelled cast iron top, door and base.
- Extractable wood drawer.
- Adjustable primary and secondary air, preset tertiary air with post combustion system.
- DSA security device (DSA valve not included).
- Ceramic glass resistant up to 750° C.
- Revêtement extérieur en faïence ou en pierre.
- Porte, élément supérieur et bâti en fonte émaillé.
- Tiroir à bois amovible.
- Air primaire et secondaire réglables, air tertiaire pré-calibré avec système post combustion.
- Dispositif de sécurité DSA (soupape DSA optionnelle).
- Vitre céramique résistante à 750° C.
- Flamme Verte: Appareil de class 7★
- Außenverkleidung aus Majolika oder Naturstein.
- Tür, Kopf und Sockel aus emailliertem Gusseisen.
- Herausziehbare Holzschublade.
- Verstellbare primär und Sekundärluft, voraustarierte Tertiärluft mit Nachverbrennungssystem.
- Sicherheitsvorrichtung DSA (DSA Sicherheitsventil OPTIONAL).
- Keramikglas bis 750° C wärmebeständig.
- Revestimiento externo de mayólica o piedra natural.
- Puerta, cabecera y base de fundición.
- Cajón extraíble por la leña.
- Aire primario y secundario regulable, aire terciario con sistema de postcombustion precalibrado.
- Dispositivo de seguridad DSA (válvula DSA opcional).
- Cristal cerámico resistente hasta 750° C.

## COLORI



Pietra Naturale



Liberty Pergamena Antico

## DATI TECNICI

	559x915x533		% 83
	162 mod. BO-PE 175 mod. PT		3,6
	355x245		130 S
	307x242x345		18,5 L
	Acciaio		bar 3



## CERTIFICAZIONI

15a B-VG

BImSchV



## TECNOLOGIA

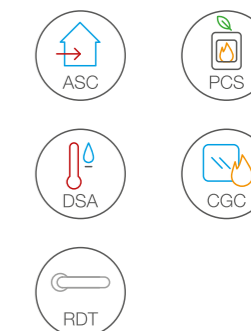

LIBERTY BORDEAUX



# TERMOROSSELLA PLUS FORNO DSA

**A+** | 13,5 kW-N | 10,5 kW-H<sub>2</sub>O | 390 m<sup>3</sup>



## PLUS

- Rivestimento esterno in maiolica o pietra naturale.
- Porta, testata e basamento in ghisa smaltata.
- Cassetto portalegna estraibile.
- Forno smaltato panoramico da 37 l.
- Aria primaria e secondaria regolabile, aria terziaria pretrata con sistema di post combustione.
- Dispositivo di sicurezza DSA (valvola DSA optional).
- Vetro ceramico resistente fino a 750° C.
- External facing in majolica or in natural stone.
- Enamelled cast iron top, door and base.
- Extractable wood drawer.
- Panoramic enamelled oven 37 l.
- Adjustable primary and secondary air, preset tertiary air with post combustion system.
- DSA security device (DSA valve not included).
- Ceramic glass resistant up to 750° C.
- Revêtement extérieur en faïence ou en pierre.
- Porte, élément supérieur et bâti en fonte émaillée.
- Tiroir à bois amovible.
- Four émaillé panoramique de 37 l.
- Air primaire et secondaire réglables, air tertiaire pré-calibré avec système post combustion.
- Dispositif de sécurité DSA (soupape DSA optionnelle).
- Vitre céramique résistante à 750° C.
- Flamme Verte: Appareil de class 7★
- Außenverkleidung aus Majolika oder Naturstein.
- Tür, Kopf und Sockel aus emailliertem Gusseisen.
- Herausziehbare Holzschublade.
- Panoramaofen emailliert mit 37 l
- Inhalt.
- Verstellbare primär und Sekundärluft, voraustarierte Tertiärluft mit Nachverbrennungssystem.
- Sicherheitsvorrichtung DSA (DSA Sicherheitsventil OPTIONAL).
- Keramikglas bis 750° C wärmebeständig.
- Revestimiento externo de mayólica o piedra natural.
- Puerta, cabecera y base de fundición.
- Cajón extraíble por la leña.
- Horno panorámico esmaltado de 37 l.
- Aire primario y secundario regulable, aire terciario con sistema de postcombustion precalibrado.
- Dispositivo de seguridad DSA (válvula DSA opcional).
- Cristal cerámico resistente hasta 750° C.

## COLORI



Pietra Naturale



Liberty Pergamena Antico

## DATI TECNICI

559x1359x533	81,1
218 mod. BO-PE 242 mod. PT	3,9
345x245	130 S
307x318x345	18,5 L
330x300x370	3 bar
Acciaio	



## CERTIFICAZIONI

15a B-VG

BImSchV



## TECNOLOGIA

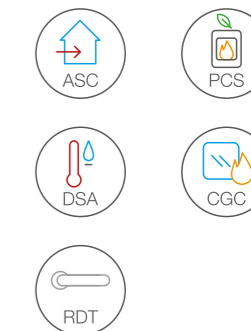



BORDEAUX

# TERMONICOLETTA EVO DSA

**A+** | 12,8 kW-N | 8,5 kW-H<sub>2</sub>O | 366 m<sup>3</sup>**PLUS**

- Rivestimento esterno in maiolica.
  - Porta in ghisa smaltata.
  - Cassetto porta legna estraibile.
  - Aria primaria e secondaria regolabile, aria terziaria pretrata con sistema di post combustione.
  - Dispositivo di sicurezza DSA (valvola DSA optional).Vetro ceramico resistente fino a 750° C.
- External facing in majolica.
  - Enamelled cast iron door.
  - Extractable wood drawer.
  - Adjustable primary and secondary air, preset tertiary air with post combustion system.
  - DSA security device (DSA valve not included).
  - Ceramic glass resistant up to 750° C.
- Revêtement extérieur en faïence.
  - Porte en fonte émaillée.
  - Tiroir à bois amovible.
  - Air primaire et secondaire réglables, air tertiaire pré-calibré avec système post combustion.
  - Dispositif de sécurité DSA (soupape DSA optionnelle).
  - Vitre céramique résistante à 750° C.
  - **Flamme Verte: Appareil de class 7★**
- Äußere Verkleidung aus Majolika.
  - Tür aus emailliertem Gusseisen.
  - Herausziehbare Holzschublade.
  - Verstellbare primär und Sekundärluft, voraustarierte Tertiärluft mit Nachverbrennungssystem.
  - Sicherheitsvorrichtung DSA (DSA Sicherheitsventil OPTIONAL).
  - Keramikglas bis 750° C wärmebeständig.
- Revestimiento exterior de mayólica.
  - Puerta de fundición esmaltada.
  - Cajón extraíble por la leña.
  - Aire primario y secundario regulable, aire terciario con sistema de postcombustion precalibrado.
  - Dispositivo de seguridad DSA (válvula DSA opcional).
  - Cristal cerámico resistente hasta 750° C.

**DATI TECNICI**

587x980x572	% 83
183	3,6
355x245	130 S
307x242x345	18,5 L
Acciaio	bar 3

**CERTIFICAZIONI****15a B-VG****BImSchV****TECNOLOGIA**



# TERMONICOLETTA FORNO DSA

**A+** | 13,5 kW-N | 10,5 kW-H<sub>2</sub>O | 390 m<sup>3</sup>



## PLUS

- Rivestimento esterno in maiolica.
- Porta in ghisa smaltata.
- Cassetto portalegna estraibile.
- Forno smaltato panoramico da 37 l.
- Aria primaria e secondaria regolabile, aria terziaria pretrata con sistema di post combustione.
- Dispositivo di sicurezza DSA (valvola DSA optional).
- Vetro ceramico resistente fino a 750° C.

- External facing in majolica.
- Enamelled cast iron door.
- Extractable wood drawer.
- Panoramic enamelled oven 37 l.
- Adjustable primary and secondary air, preset tertiary air with post combustion system.
- DSA security device (DSA valve not included).
- Ceramic glass resistant up to 750° C.

- Revêtement extérieur en faïence.
- Porte en fonte émaillée.
- Tiroir à bois amovible.
- Four émaillé panoramique de 37 l.
- Air primaire et secondaire réglables, air tertiaire pré-calibré avec système post combustion.
- Dispositif de sécurité DSA (soupape DSA optionnelle).
- Vitre céramique résistante à 750° C.
- Flamme Verte: Appareil de class 7★

- Äußere Verkleidung aus Majolika.
- Tür aus emailliertem Gusseisen.
- Herausziehbare Holzschublade.
- Panoramaofen emailliert mit 37 l Inhalt.
- Verstellbare primär und Sekundärluft, voraustarierte Tertiärluft mit Nachverbrennungssystem.
- Sicherheitsvorrichtung DSA (DSA Sicherheitsventil OPTIONAL).
- Keramikglas bis 750° C wärmebeständig.

- Revestimiento exterior de mayólica.
- Puerta de fundición esmaltada.
- Cajón extraíble por la leña.
- Horno panorámico esmaltado de 37 l.
- Aire primario y secundario regulable, aire terciario con sistema de postcombustion precalibrado.
- Dispositivo de seguridad DSA (válvula DSA opcional).
- Cristal cerámico resistente hasta 750° C.

## DATI TECNICI

587x1423x572	% 81,1
254	3,9
345x245	130 S
307x318x345	18,5 L
330x300x370	bar 3
Acciaio	



## CERTIFICAZIONI

**15a B-VG**

**BlmSchV**



## TECNOLOGIA

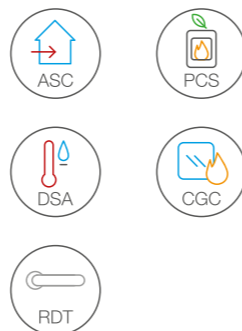

TERMO PRODOTTI





BORDEAUX

# LORIET S DSA

**A<sup>+</sup>** | 16,8 kW-N | 10,5 kW-H<sub>2</sub>O | 481 m<sup>3</sup>**CONTO TERMICO**

Per maggiori informazioni consultare il nostro sito:

[www.lanordica-extraflame.com](http://www.lanordica-extraflame.com)

## PLUS

- Rivestimento esterno in maiolica
  - Porta e piastra in ghisa vetrificata
  - Aria primaria e secondaria regolabile, aria terziaria prearata con sistema di post combustione
  - Dispositivo di sicurezza DSA (valvola DSA optional).
  - Vetro ceramico resistente fino a 750° C
- External facing in majolica
  - Door and plate in polished cast iron
  - Adjustable primary and secondary air, preset tertiary air with post combustion system
  - DSA security device (DSA valve not included).
  - Ceramic glass resistant up to 750° C
- Revêtement extérieur en faïence
  - Porte et plaque en fonte vitrifiée
  - Air primaire et secondaire réglables, air tertiaire pré-calibré avec système post combustion
  - Dispositif de sécurité DSA (soupape DSA optionnelle).
  - Vitre céramique résistante à 750° C
  - Flamme Verte: Appareil de class 7★

- Äußere Verkleidung aus Majolika
  - Tür und Platte aus verglastem Gusseisen
  - Verstellbare primär und Sekundärluft, voraustarierte Tertiärluft mit Nachverbrennungssystem
  - Sicherheitsvorrichtung DSA (DSA Sicherheitsventil OPTIONAL).
  - Keramikglas bis 750° C wärmebeständig
- Revestimiento exterior de mayólica
  - Puerta y placa de hierro fundido vitrificado
  - Aire primario y secundario regulable, aire terciario con sistema de postcombustion precalibrado
  - Dispositivo de seguridad DSA (válvula DSA opcional).
  - Cristal cerámico resistente hasta 750° C

## COLORI



Bianco Infinity

## DATI TECNICI

	570x1258x567		% 88
	203		4,3
	325x223		Ø 130 S
	330x300x345		50 L
	Ghisa/Acciaio		bar 3



## CERTIFICAZIONI

**15a B-VG****BlmSchV**

## TECNOLOGIA





Ghisa smaltata

# TERMOISOTTA DSA

**A** | 15 kW-N | 8,5 kW-H<sub>2</sub>O | 430 m<sup>3</sup>**PLUS**

- Stufa interamente in ghisa smaltata.
  - Porta di carica frontale.
  - Ghisa ad alto rendimento termico.
  - Aria primaria e secondaria regolabile, aria terziaria pretrata con sistema di post combustione.
  - Dispositivo di sicurezza DSA (valvola DSA optional).
  - Vetro ceramico resistente fino a 750° C.
- Stove made completely of Enamelled cast-iron.
  - Front loading door.
  - Very high thermic yield cast-iron.
  - Adjustable primary and secondary air, preset tertiary air with post combustion system.
  - DSA security device (DSA valve not included).
  - Ceramic glass resistant up to 750° C.
- Poêle entièrement en fonte émaillée.
  - Porte de chargement frontal.
  - Fonte à rendement thermique élevé.
  - Air primaire et secondaire réglables, air tertiaire pré-calibré avec système post combustion.
  - Dispositif de sécurité DSA (soupape DSA optionnelle).
  - Vitre céramique résistante à 750° C.
- Ofen vollständig aus emailliertem Gusseisen.
  - Tür Frontbeschickung.
  - Gusseisen mit hoher Wärmeleistung.
  - Verstellbare primär und Sekundärluft, voraustarierte Tertiärluft mit Nachverbrennungssystem. Sicherheitsvorrichtung DSA (DSA Sicherheitsventil OPTIONAL).
  - Keramikglas bis 750° C wärmebeständig.
- Estufa completamente de fundición esmaltada.
  - Puerta de carga frontal.
  - Fundición de alto rendimiento térmico.
  - Aire primario y secundario regulable, aire terciario con sistema de postcombustion precalibrado.
  - Dispositivo de seguridad DSA (válvula DSA opcional).
  - Cristal cerámico resistente hasta 750° C.

**DATI TECNICI**

	760x775x520		% 78,4
	212		4,4
	519x340		150 S
	570x300x325		14,5 L
	Ghisa/Nordiker		bar 3

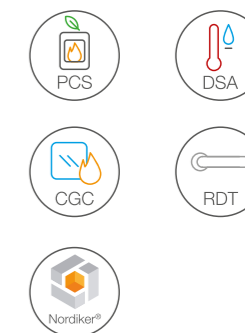
**CERTIFICAZIONI****BlmSchV****TECNOLOGIA**

Sistema DSA

# TERMOCUCINOTTA EVO DSA









**A** | 16,9 kW-N | 11,9 kW-H<sub>2</sub>O | 484 m<sup>3</sup>

## PLUS

- Rivestimento esterno in ghisa smaltata.
  - Telaio in ghisa vetrificata.
  - Piastra e cerchi in ghisa levigata.
  - Cassettone portalegna.
  - Aria primaria e secondaria regolabile, aria terziaria pretrata con sistema di post combustione.
  - Dispositivo di sicurezza DSA (valvola DSA optional).
- External covering in Enamelled cast-iron.
  - Vitrified cast-iron top frame.
  - Top cooking plate and rings in polished cast-iron.
  - Wood drawer.
  - Adjustable primary and secondary air, preset tertiary air with post combustion system.
  - DSA security device (DSA valve not included).
- Revêtement extérieur en fonte émaillée.
  - Châssis en fonte vitrifiée.
  - Plaque et cercles en fonte polie.
  - Tiroir de rangement bois.
  - Air primaire et secondaire réglables, air tertiaire pré-calibré avec système post combustion.
  - Dispositif de sécurité DSA (soupape DSA optionnelle).
- Außenverkleidung aus emailliertem Gusseisen.
  - Rahmen aus verglastem Gusseisen.
  - Platte und Ringe aus geschliffenem Gusseisen.
  - Große Holzschublade.
  - Verstellbare primär und Sekundärluft, voraustarierte Tertiärluft mit Nachverbrennungssystem.
  - Sicherheitsvorrichtung DSA (DSA Sicherheitsventil OPTIONAL).
- Revestimiento externo de fundición esmaltada.
  - Bastidor de fundición vitrificada.
  - Plancha y aros de fundición pulida.
  - Cajón gran para la leña.
  - Aire primario y secundario regulable, aire terciario con sistema de postcombustion precalibrado.
  - Dispositivo de seguridad DSA (válvula DSA opcional).

NERO

## DATI TECNICI

	682x860x679	%	78,8
	205		4,9
	405x260		150 S
	415x275x475		20,5 L
	Acciaio	bar	3,0



## CERTIFICAZIONI

**BImSchV**

## TECNOLOGIA



# NORMA S IDRO DSA

**A** | 19,5 kW-N | 14,9 kW-H<sub>2</sub>O | 559 m<sup>3</sup>



## PLUS

- Rivestimento esterno in maiolica.
- Basamento, testata e porta in ghisa.
- Rivestimento interno del focolare in acciaio.
- Focolare a fiamma verticale.
- Aria primaria e secondaria regolabile, aria terziaria pretrata con sistema di post combustione.
- Dispositivo di sicurezza DSA (valvola DSA optional).
- Vetro ceramico resistente a 750° C in pezzo unico.
- Äußere Verkleidung aus Majolika.
- Sockel, Kopf und Tür aus Gusseisen.
- Innenverkleidung der Feuerstelle aus Stahl.
- Feuerstätte mit senkrechter Flamme.
- Verstellbare primär und Sekundärluft, voraustarierte Tertiärluft mit Nachverbrennungssystem.
- Sicherheitsvorrichtung DSA (DSA Sicherheitsventil OPTIONAL).
- Glaskeramikfenster, hitzebeständig bis auf 750° C, an einem Stück.
- Revestimiento exterior de mayólica.
- Base, cabecera y puerta de fundición.
- Revestimiento interno del hogar de acero.
- Hogar con llama vertical.
- Aire primario y secundario regulable, aire terciario con sistema de postcombustion precalibrado.
- Dispositivo de seguridad DSA (válvula DSA opcional).
- Cristal cerámico resistente hasta 750° C en un bloque único.
- Revêtement extérieur en faïence.
- Bâti, élément supérieur et porte en fonte.
- Revêtement interne du foyer en acier.
- Foyer à flamme verticale.
- Air primaire et secondaire réglables, air tertiaire pré-calibré avec système post combustion.
- Dispositif de sécurité DSA (soupape DSA optionnelle).
- Vitre céramique résistant à 750° C en une seule pièce.

## COLORI



Titanio

## DATI TECNICI

720x1242x575	% 78,6
249	5,8
424x350	160 S
424x450x320	40 L
Acciaio	bar 2,5



## CERTIFICAZIONI

**BlmSchV**

## TECNOLOGIA

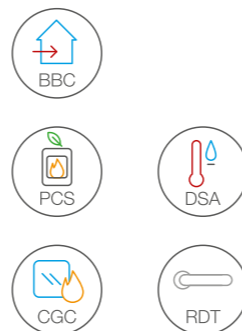

TERMO PRODOTTI



BORDEAUX

# NORMA S EVO IDRO DSA

**A+** | 17,5 kW-N | 10,6 kW-H<sub>2</sub>O | 501 m<sup>3</sup>



CONTO TERMICO

Per maggiori informazioni consultare il nostro sito:

www.lanordica-extraflame.com

TERMO PRODOTTI

## PLUS

- Rivestimento esterno in maiolica.
  - Basamento, testata e porta in ghisa.
  - Rivestimento interno del focolare in acciaio.
  - Focolare a fiamma verticale.
  - Aria primaria e secondaria regolabile, aria terziaria pretrata con sistema di post combustione.
  - Dispositivo di sicurezza DSA (valvola DSA optional).
  - Vetro ceramico resistente a 750° C in pezzo unico.
- External facing in majolica.
  - Base, top and door in cast iron.
  - Internal hearth covering in steel.
  - Vertical flame hearth.
  - Adjustable primary and secondary air, preset tertiary air with post combustion system.
  - DSA security device (DSA valve not included).
  - Ceramic glass heat-resistant 750° C in a single piece.
- Revêtement extérieur en majolique.
  - Bâti, élément supérieur et porte en fonte.
  - Revêtement interne du foyer en acier.
  - Foyer à flamme verticale.
  - Air primaire et secondaire réglables, air tertiaire pré-calibré avec système post combustion.
  - Dispositif de sécurité DSA (soupape DSA optionnelle).
  - Vitre céramique résistant à 750° C en une seule pièce.
  - Flamme Verte: Appareil de class 7★
- Äußere Verkleidung aus Majolika
  - Sockel, Kopf und Tür aus Gusseisen.
  - Innenverkleidung der Feuerstelle aus Stahl.
  - Feuerstätte mit senkrechter Flamme.
  - Verstellbare primär und Sekundärluft, voraustarierte Tertiärluft mit Nachverbrennungssystem.
  - Sicherheitsvorrichtung DSA (DSA Sicherheitsventil OPTIONAL).
  - Glaskeramikfenster, hitzebeständig bis auf 750° C, an einem Stück.
- Revestimiento exterior de mayólica.
  - Base, cabecera y puerta de fundición.
  - Revestimiento interno del hogar de acero.
  - Hogar con llama vertical.
  - Aire primario y secundario regulable, aire terciario con sistema de postcombustion precalibrado.
  - Dispositivo de seguridad DSA (válvula DSA opcional).
  - Cristal cerámico resistente hasta 750° C en un bloque único.

## COLORI



Pergamena



Bordeaux

## DATI TECNICI

731x1246x634	% 85,3
245	4,8
424x350	160 S
424x337x320	40 L
Acciaio	bar 2,5



## CERTIFICAZIONI

15a B-VG

BlmSchV



## TECNOLOGIA



TITANIO





Bianco Infinity

# NORMA CLASSIC S EVO IDRO DSA\*

**A+** | 17,5 kW-N | 10,6 kW-H<sub>2</sub>O | 501 m<sup>3</sup>**PLUS**

- Rivestimento esterno in maiolica.
  - Basamento e porta in ghisa.
  - Rivestimento interno del focolare in acciaio.
  - Focolare a fiamma verticale. ★
  - Aria primaria e secondaria regolabile, aria terziaria pretrata con sistema di post combustione.
  - Dispositivo di sicurezza DSA (valvola DSA optional).
  - Vetro ceramico resistente a 750° C in pezzo unico.
- Room ventilation.
  - External facing in majolica.
  - Base and door in cast iron.
  - Internal hearth covering in steel.
  - Vertical flame hearth.
  - Adjustable primary and secondary air, preset tertiary air with post combustion system.
  - DSA security device (DSA valve not included).
  - Ceramic glass heat-resistant 750° C in a single piece.
- Revêtement extérieur en faïence.
  - Bâti et porte en fonte.
  - Revêtement interne du foyer en acier.
  - Foyer à flamme verticale.
  - Air primaire et secondaire réglables, air tertiaire pré-calibré avec

- système post combustion.
  - Dispositif de sécurité DSA (soupape DSA optionnelle).
  - Vitre céramique résistant à 750° C en une seule pièce.
  - Flamme Verte: Appareil de class 7.
- Äußere Verkleidung aus Majolika.
  - Sockel und Tür aus Gusseisen.
  - Innenverkleidung der Feuerstelle aus Stahl.
  - Feuerstätte mit senkrechter Flamme.
  - Verstellbare primär und Sekundärluft, voraustarierte Tertiärluft mit Nachverbrennungssystem.
  - Sicherheitsvorrichtung DSA (DSA Sicherheitsventil OPTIONAL).
  - Glaskeramikfenster, hitzebeständig bis auf 750° C, an einem Stück.
- Revestimiento exterior de mayólica.
  - Base y puerta de hierro fundido.
  - Revestimiento interno del hogar de acero.
  - Hogar con llama vertical.
  - Aire primario y secundario regulable, aire terciario con sistema de postcombustion precalibrado.
  - Dispositivo de seguridad DSA (válvula DSA opcional).
  - Cristal cerámico resistente hasta 750° C en un bloque único.

**COLORI**

Bordeaux

**DATI TECNICI**

766x1272x647	% 85,3
227	4,8
424x350	160 S
424x337x320	40 L
Acciaio	bar 2,5

**CERTIFICAZIONI****15a B-VG****BImSchV****TECNOLOGIA****CONTO TERMICO**

Per maggiori informazioni consultare il nostro sito:

[www.lanordica-extraflame.com](http://www.lanordica-extraflame.com)



BIANCO INFINITY

# NORMA STEEL S EVO IDRO DSA

**A+** | 17,5 kW-N | 10,6 kW-H<sub>2</sub>O | 501 m<sup>3</sup>

## PLUS

- Rivestimento esterno in acciaio verniciato e testata in maiolica.
  - Basamento e porta in ghisa.
  - Rivestimento interno del focolare in acciaio.
  - Focolare a fiamma verticale.
  - Aria primaria e secondaria regolabile, aria terziaria pretrata con sistema di post combustione.
  - Dispositivo di sicurezza DSA (valvola DSA optional).
  - Vetro ceramico resistente a 750° C in pezzo unico.
- External facing in painted steel and majolica.
  - Base and door in cast iron.
  - Internal hearth covering in steel.
  - Vertical flame hearth.
  - Adjustable primary and secondary air, preset tertiary air with post combustion system.
  - DSA security device (DSA valve not included).
  - Ceramic glass heat-resistant 750° C in a single piece.
- Revêtement extérieure en acier peint et tête en majolique.
  - Bâti et porte en fonte.
  - Revêtement interne du foyer en acier.
  - Foyer à flamme verticale.
  - Air primaire et secondaire réglables, air tertiaire pré-calibré avec système post combustion.
  - Dispositif de sécurité DSA (soupape DSA optionnelle).
  - Vitre céramique résistant à 750° C en une seule pièce.
  - Flamme Verte: Appareil de class 7★
- Außenverkleidung aus lackiertem Stahl und obere Platte aus Majolika.
  - Sockel und Tür aus Gusseisen.
  - Innenverkleidung der Feuerstelle aus Stahl.
  - Feuerstätte mit senkrechter Flamme.
  - Verstellbare primär und Sekundärluft, voraustarierte Tertiärluft mit Nachverbrennungssystem.
  - Sicherheitsvorrichtung DSA (DSA Sicherheitsventil OPTIONAL).
  - Glaskeramikfenster, hitzebeständig bis auf 750° C, an einem Stück.
- Revestimiento externo de acero barnizado y cabecera de mayólica.
  - Base y puerta de hierro fundido.
  - Revestimiento interno del hogar de acero.
  - Hogar con llama vertical.
  - Aire primario y secundario regulable, aire terciario con sistema de postcombustion precalibrado.
  - Dispositivo de seguridad DSA (válvula DSA opcional).
  - Cristal cerámico resistente hasta 750° C en un bloque único.

**CONTO TERMICO**Per maggiori informazioni  
consultare il nostro sito:[www.lanordica-extraflame.com](http://www.lanordica-extraflame.com)

## DATI TECNICI

	766x1272x647	%	85,3
	204		4,8
	424x350		160 S
	424x337x320		40 L
	Acciaio	bar	2,5



## CERTIFICAZIONI

**15a B-VG****BlmSchV**

## TECNOLOGIA





## SERIE TERMOCUCINE

Le moderne termocucine a legna La Nordica coniugano la tecnologia e la cura dei materiali con i valori della tradizione e i sapori di una volta, per offrire la possibilità di cucinare in libertà e al contempo riscaldare la tua casa.

### THERMO COOKERS SERIES:

The modern La Nordica wood burning thermo cookers combine technology and the care for materials with the values of tradition and the flavours of the past, to offer the possibility of cooking freely and heating your home at the same time.

### SÉRIE THERMO CUISINIÈRES:

Les modernes thermo cuisinières à bois La Nordica allient la technologie et le soin des matériaux avec les valeurs de la tradition et des saveurs d'antan, pour offrir la possibilité de cuisiner en toute liberté et, en même temps, de chauffer votre maison.

### SERIE WASSERFÜHRENDE:

Die modernen Wasserführende Holzherde La Nordica verbinden die Technologie und die Materialpflege mit den traditionellen Werten und den Geschmäckern von früher, und bieten so die Möglichkeit, frei zu kochen und gleichzeitig Ihr Heim zu heizen.

### SERIE TERMOCOCINAS:

Las modernas termococinas de leña La Nordica conjugan la tecnología y el cuidado de los materiales con los valores de la tradición y los sabores antiguos, para darte la posibilidad de cocinar libremente y al mismo tiempo calentar tu casa.



La presenza di un circuito anticondensa è un elemento obbligatorio per avere la garanzia di fabbrica sui TermoProdotti.

The presence of the anti-condensation valve is an essential element for the factory warranty on the product.

La présence de la vanne anti-condensation est un élément dont il faut tenir compte pour avoir la garantie de fabrique sur le produit.

Die Anwesenheit eines Antikondenswasserventils ist ein unumgängliches Element, um die Werksgarantie des Produkts zu erlangen.

La presencia de la válvula anticondensación es un elemento imprescindible para tener la garantía de fábrica del producto.

# TERMOSOVRAANA DSA

**A<sup>+</sup>** | 13,5 kW-N | 9 kW-H<sub>2</sub>O | 387 m<sup>3</sup>

## PLUS

- Rivestimento esterno in acciaio porcellanato.
  - Forno smaltato con doppio vetro da 41 l.
  - Telaio in ghisa vetrificata.
  - Piastra e cerchi in ghisa levigata.
  - Fianchi a convezione termica.
  - Cassettoni portalegna.
  - Aria primaria e secondaria regolabile, aria terziaria pretrata con sistema di post combustione.
  - Dispositivo di sicurezza DSA (valvola DSA optional).
  - Coperchio di serie
- Außenverkleidung aus porzellan-emailliertem Stahl.
  - Emailierter Ofen mit Doppelglas mit 41 l Inhalt.
  - Rahmen aus verglastem Gusseisen.
  - Platte und Ringe aus geschliffenem Gusseisen.
  - Seiten mit Wärmekonvektion.
  - Große Holzschublade.
  - Verstellbare primär und Sekundärluft, voraustarierte Tertiärluft mit Nachverbrennungssystem.
  - Sicherheitsvorrichtung DSA (DSA Sicherheitsventil OPTIONAL).
  - Serienmäßige Abdeckung.
- Revestimiento externo de acero esmaltado.
  - Horno esmaltado con cristal doble de 41 l.
  - Bastidor de fundición vitrificada.
  - Plancha y aros de fundición pulida.
  - Laterales de convección térmica.
  - Cajón grande pala la leña.
  - Aire primaria y secundaria regulable, aire terciaria con sistema de postcombustion precalibrado.
  - Dispositivo de seguridad DSA (válvula DSA opcional).
  - Tapa de serie.
- Glazed steel external facing.
  - Panoramic enamelled oven 41 l.
  - Vitrified cast-iron top frame.
  - Top cooking plate and rings in polished cast-iron.
  - Thermo convection sides.
  - Wood drawer.
  - Adjustable primary and secondary air, preset tertiary air with post combustion system.
  - DSA security device (DSA valve not included).
  - Cover as standard
- Revêtement extérieur en acier émaillé.
  - Four émaillé avec double vitre de 41 l.
  - Châssis en fonte vitrifié.
  - Plaque et cercles en fonte polie
  - Côtés à convection thermique.
  - Tiroir de rangement bois.
  - Air primaire et secondaire réglables, air tertiaire pré-calibré avec système post combustion.
  - Dispositif de sécurité DSA (soupape DSA optionnelle).
  - Couvercle en série.
  - Flamme Verte: Appareil de class 7★

## COLORI



Bianco

## DATI TECNICI

	964x889x640		81,2
	166		3,9
	217x172		130 S/P
	257x250x395		12 L
	330x300x410		3 bar
	Acciaio		



## CERTIFICAZIONI

**BImSchV**



## TECNOLOGIA



Nero Antracite





LIBERTY BORDEAUX



# TERMOROSA DSA

**A** | 15,5 kW-N | 9 kW-H<sub>2</sub>O | 444 m<sup>3</sup>

## PLUS

- Rivestimento esterno in maiolica o pietra naturale.
  - Forno smaltato panoramico da 41 l.
  - Telaio in ghisa vetrificata.
  - Piastra e cerchi in ghisa levigata.
  - Cassettone portalegna.
  - Aria primaria e secondaria regolabile, aria terziaria prearata con sistema di post combustione.
  - Dispositivo di sicurezza DSA (valvola DSA optional).
- External facing in majolica or in natural stone.
  - Panoramic enamelled oven 41 l.
  - Vitrified cast-iron top frame.
  - Top cooking plate and rings in polished cast-iron.
  - Wood drawer.
  - Adjustable primary and secondary air, preset tertiary air with post combustion system.
  - DSA security device (DSA valve not included).
- Revêtement extérieur en faïence ou en pierre.
  - Four émaillé panoramique de 41 l.
  - Châssis en fonte vitrifiée.
  - Plaque et cercles en fonte polie
  - Tiroir de rangement bois.
  - Air primaire et secondaire réglables, air tertiaire pré-calibré avec système post combustion.
  - Dispositif de sécurité DSA (soupape DSA optionnelle).
  - Flamme Verte: Appareil de class 7★

- Außenverkleidung aus Majolika oder Naturstein.
- Panoramaofen emailliert mit 41 l Inhalt.
- Rahmen aus verglastem Gusseisen.
- Platte und Ringe aus geschliffenem Gusseisen.
- Große Holzschublade.
- Verstellbare primär und Sekundärluft, voraustarierte Tertiärluft mit Nachverbrennungssystem.
- Sicherheitsvorrichtung DSA (DSA Sicherheitsventil OPTIONAL).

- Revestimiento externo de mayólica o piedra natural.
- Horno panorámico esmaltado de 41 l.
- Bastidor de fundición vitrificada.
- Plancha y aros de fundición pulida.
- Cajón gran para la leña.
- Aire primario y secundario regulable, aire terciario con sistema de postcombustion precalibrado.
- Dispositivo de seguridad DSA (válvula DSA opcional).

## COLORI



Pietra Naturale

## DATI TECNICI

↓ 1017x852x662	% 79,9
kg 211 mod. BO 226 mod. PT	🕒 4,5
🏠 220x225	🌀 150 S/P
📦 265x285x400	🗑️ 14 L
📦 330x300x410	bar 3
🏠 Acciaio	



## CERTIFICAZIONI

15a B-VG

BlmSchV



## TECNOLOGIA



AE5-P-057  
certificazionesariaPulita.it



NERO ANTRACITE



# TERMOROSA XXL DSA

**A+** | 18,4 kW-N | 15,1 kW-H<sub>2</sub>O | 527 m<sup>3</sup>



## PLUS

- Rivestimento esterno in acciaio porcellanato.
- Porte e facciata in ghisa vetrificata.
- Porta fuoco con doppio vetro.
- Grande forno smaltato da 55 l.
- Piastra e cerchi in ghisa levigata.
- Cassettone portalegna.
- Dispositivo di sicurezza DSA (valvola DSA optional).
- Griglia forno cromata di serie.

- Enamelled external facing.
- Doors and facade in polished cast iron .
- Double glass fire door.
- Large enamelled oven 55 l.
- Top cooking plate and rings in polished cast-iron.
- Wood drawer.
- DSA security device (DSA valve not included).
- Chromed oven rack.

- Revêtement extérieur en acier émaillé.
- Portes et façade en fonte vitrifiée.
- Porte foyer avec double vitre.
- Grand four émaillé de 55 l.
- Plaque et cercles en fonte polie.
- Tiroir de rangement bois.
- Dispositif de sécurité DSA (soupape DSA optionnelle).
- Chromed oven rack.
- **Flamme Verte: Appareil de class 7★**

- Außenverkleidung aus porzellan-emailliertem Stahl.
- Türen und Ansichtseite aus verglastem Gusseisen.
- Feuertür mit Doppelglas.
- Großer emaillierter Ofen mit 55 l Inhalt.
- Platte und Ringe aus geschliffenem Gusseisen.
- Große Holzschublade.
- Sicherheitsvorrichtung DSA (DSA Sicherheitsventil OPTIONAL).
- Ausgestattet mit Backofenrost.

- Revestimiento externo de acero esmaltado.
- Puertas y frontal de fundición vitrificada.
- Puerta con cristal doble.
- Horno gran esmaltado de 55 l.
- Plancha y aros de fundición pulida.
- Cajón gran para la leña.
- Dispositivo de seguridad DSA (válvula DSA opcional).
- Equipada con rejilla de horno cromada.

## DATI TECNICI

	1074x861x690		% 83
	275		5,2
	225x158		160 S/P
	257x350x405		22 L
	307x418x430		bar 3
	Acciaio		



## CERTIFICAZIONI

15a B-VG

BImSchV



## TECNOLOGIA





NERO

# TERMOSUPREMA COMPACT DSA

**A+** | 18,5 kW-N | 15 kW-H<sub>2</sub>O | 530 m<sup>3</sup>AE5-P-047  
certificazioneariapulita.it

## PLUS

- Rivestimento esterno in ghisa smaltata.
  - Forno smaltato panoramico da 55 l.
  - Telaio in ghisa vetrificata.
  - Piastra e cerchi in ghisa levigata.
  - Cassettone portalegna.
  - Aria primaria e secondaria regolabile, aria terziaria prearata con sistema di post combustione.
  - Dispositivo di sicurezza DSA (valvola DSA optional).
  - Griglia forno cromata di serie.
- Außenverkleidung aus emailliertem Gusseisen.
  - Panoramaofen emailliert mit 55 l Inhalt.
  - Rahmen aus verglastem Gusseisen.
  - Platte und Ringe aus geschliffenem Gusseisen.
  - Große Holzschublade.
  - Verstellbare primär und Sekundärluft, voraustarierte Tertiärluft mit Nachverbrennungssystem.
  - Sicherheitsvorrichtung DSA (DSA Sicherheitsventil OPTIONAL).
  - Ausgestattet mit Backofenrost.
- Revestimiento externo de fundición esmaltada.
  - Horno panorámico esmaltado de 55 l.
  - Bastidor de fundición vitrificada.
  - Plancha y aros de fundición pulida.
  - Cajón gran para la leña.
  - Aire primario y secundario regulable, aire terciario con sistema de postcombustion precalibrado.
  - Dispositivo de seguridad DSA (válvula DSA opcional).
  - Equipada con rejilla de horno cromada.
- Revêtement extérieur en fonte émaillé.
  - Four émaillé panoramique de 55 l.
  - Châssis en fonte vitrifiée.
  - Plaque et cercles en fonte polie.
  - Tiroir de rangement bois.
  - Air primaire et secondaire réglables, air tertiaire pré-calibré avec système post combustion.
  - Dispositif de sécurité DSA (soupape DSA optionnelle).
  - Équipé d'une grille chromée pour le four.
  - Flamme Verte: Appareil de class 7★

## DATI TECNICI

	982x860x682	%	83
	293		5,2
	233x160		160 S/P
	257x350x407		22 L
	307x418x430	bar	3
	Acciaio		



## CERTIFICAZIONI

**15a B-VG****BlmSchV**

## TECNOLOGIA



# MODULO ALL INCLUSIVE UNIVERSALE DSA 2.0

## PLUS

Il modulo è dotato di: sicurezze, vaso d'espansione, sistema di circolazione, sistema per la produzione di acqua sanitaria. La gestione del funzionamento è affidata ad un regolatore elettronico digitale sempre a bordo macchina e dal display a controllo remoto (in dotazione).

The set is equipped with: safety valves, expansion vessel, circulating system, sanitary water production system. The operation is controlled by an on-board electronic device and a display with remote control (supplied with the appliance).

Le module est équipé avec: sécurités, vase d'expansion, système de circulation, système pour la production d'eau chaude sanitaire. La gestion du fonctionnement est réglée par un régulateur électronique digital qui est déjà fourni avec l'appareil et par le display à contrôle à distance (standard).

Das Modul verfügt über: Sicherheitsventile, Ausdehnungsgefäß, Zirkulationssystem und Sanitärwarmwassersystem. Der Betrieb wird durch eine elektronische bzw. digitale Steuerung an der Maschine und ein grafisches Display mit Fernkontrolle geregelt (serienmäßig).

El modulo está equipado con unos dispositivos de seguridad, deposito de expansión, sistema de circulación, sistema para la producción de agua sanitaria. El control del aparato viene hecho por un regulador electrónico digital siempre a bordo de la maquina y por el display con mando a distancia (incluido).



Collegabile con - Connectable with - Possibilità de branchement avec  
- Verbindbar mit - Conectable con:



Nero Antracite

Con il Modulo All-Inclusive Universale diventa facile installare un termoprodotto.

All-Inclusive Modulo Universale makes a thermoproduct installation easier.

Avec le Module All-Inclusive Universale il devient facile d'installer un thermo-produit.

Mit dem Modulo All-Inclusive Universale wird es leicht, ein Thermoprodukt zu installieren.

Con el Modulo All-Inclusive Universale la instalación de un termo producto se pone fácil.



TermoSovrana DSA



TermoRosa DSA



TermoRosa XXL DSA



TermoSuprema Compact DSA

## TERMOCUCINE

## COLORI



Nero Antracite



TermoRossella Evo DSA



TermoRossella Forno DSA



TermoNicoletta Evo DSA



TermoNicoletta Forno DSA



Loriet S DSA



Termolsotta DSA



Norma S Idro DSA



Norma Classic S Evo Idro DSA



Norma Steel S Evo Idro DSA



TermoCucinotta Evo DSA



TermoNatalie DSA

## TERMOSTUFE

## DATI TECNICI

458x876x674

100 kg

100 W



Focolare 80 Idro Crystal DSA



TermoCamino WF25X - DSA



TermoCamino WF Plus DSA

## TERMOCAMINI

## SERIE TERMOCAMINI

I termocamini a legna La Nordica sono la soluzione ideale per affrontare l'inverno in tranquillità usufruendo del massimo rendimento calorico con il minimo dispendio energetico.



### THERMO FIREPLACES SERIES:

The wood burning thermo fireplaces La Nordica are the ideal solution to face the winter in tranquillity exploiting the maximum heat yield with the minimal energy consumption.

### SÉRIE THERMO CHEMINÉES:

Les Thermo cheminées à bois sont la solution idéale pour faire face à l'hiver en tranquillité, en profitant d'un rendement calorifique maximum sans gaspillage d'énergie.

### SERIE THERMOKAMINE:

Die Wasserführende Scheitholz Kamine La Nordica sind die Ideallösung um dem Winter in aller Ruhe entgegenzutreten, erlaubt Ihnen das genießen der maximalen Heizleistung, mit dem geringsten Energieverbrauch.

### SERIE TERMOCHIMENEA:

Los Termochimenea de leña La Nordica son la solución ideal para enfrentar el invierno aprovechando del máximo rendimiento calorífico con el mínimo dispendio energético.

La presenza di un circuito anticondensa è un elemento obbligatorio per avere la garanzia di fabbrica sui TermoProdotti.  
The presence of the anti-condensation valve is an essential element for the factory warranty on the product.  
La présence de la vanne anti-condensation est un élément dont il faut tenir compte pour avoir la garantie de fabrique sur le produit.  
Die Anwesenheit eines Antikondenswasserventils ist ein unumgängliches Element, um die Werksgarantie des Produkts zu erlangen.  
La presencia de la válvula anticondensación es un elemento imprescindible para tener la garantía de fábrica del producto.



Cassetto cenere estraibile  
Extractable ash drawer  
Tiroir cendrier extractible  
Ausziehbarer Aschenkasten  
Cenicero extraíble



Possibilità autonoma di cambiare l'apertura destra o sinistra della porta  
Possibility to change by yourself the door opening direction from right to left  
Possibilité de changer en autonomie l'ouverture de la porte vers droite ou vers gauche  
Möglichkeit, selbständig die Öffnungsrichtung der Tür nach rechts oder nach links zu ändern  
Posibilidad autónoma de mudar la abertura derecha o izquierda de la puerta



## FOCOLARE 80 IDRO CRYSTAL DSA

**A+** | 15,4 kW-N | 11,1 kW-H<sub>2</sub>O | 441 m<sup>3</sup>



### PLUS

- Cassetto cenere estraibile
- Focolare in ghisa-Nordiker
- Vetro ceramico resistente fino a 750° C
- Aria primaria e secondaria regolabile, aria terziaria prearata con sistema di post combustione
- Dispositivo di sicurezza DSA (valvola DSA optional)
- Extractable ashbox
- Hearth in cast-iron and Nordiker
- Ceramic glass heat-resistant up to 750° C
- Adjustable primary and secondary air, preset tertiary air with post combustion system
- DSA security device (DSA valve not included)
- Tiroir à cendres dissimulé
- Foyer en fonte et Nordiker
- Vitre céramique résistant à 750° C
- Air primaire et secondaire réglables, air tertiaire pré-calibré avec système post combustion
- Dispositif de sécurité DSA (soupape DSA optionnelle)
- Flamme Verte: Appareil de class 7★
- Herausziehbare Ascheschublade
- Feuerraumverkleidung aus Gusseisen und aus Nordiker
- Keramikglas bis 750° C hitzebeständig
- Verstellbare Primär und Sekundärluft, voraustarierte Tertiärluft mit Nachverbrennungssystem
- Sicherheitsvorrichtung DSA (DSA Sicherheitsventil OPTIONAL)
- Cajón ceniza extraíble
- Hogar de fundición y Nordiker
- Cristal cerámico resistente hasta 750° C
- Aire primaria y secundaria regulable, aire terciaria con sistema de postcombustion precalibrado
- Dispositivo de seguridad DSA (válvula DSA opcional)

### DATI TECNICI

800x1192x560	4,3
178	160
635x245	20 L
590x320x350	bar 3
82,7	



### CERTIFICAZIONI

**15a B-VG**  
**BlmSchV**



### TECNOLOGIA

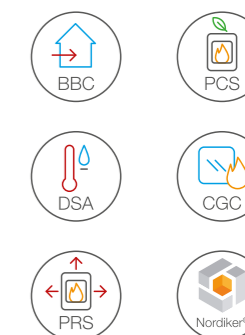



Percorso aria secondaria regolabile  
Adjustable secondary air route  
Parcours d'air secondaire réglable  
Verlauf Sekundärluft einstellbar  
Recorrido de aire secundario regulable







## TERMOCAMINO WF25 X - DSA

**A** | 27,1 kW-N | 18,2 kW-H<sub>2</sub>O | 777 m<sup>3</sup>

### PLUS

- Costruito interamente in acciaio
- Focolare in ghisa e acciaio
- Vetro a scomparsa
- Ampio braciere in ghisa di grosso spessore
- Aria primaria e secondaria regolabile, aria terziaria prearata con sistema di post combustione
- Dispositivo di sicurezza DSA (valvola DSA optional)
- Completely made of steel
- Hearth in cast iron and steel
- Disappearing glass
- Thick cast iron large brazier
- Adjustable primary and secondary air, preset tertiary air with post combustion system
- DSA security device (DSA valve not included)
- Entièrement en acier
- Foyer en fonte et acier
- Vitre escamotable
- Grand brasier en fonte de grande épaisseur
- Air primaire et secondaire réglables, air tertiaire pré-calibré avec système post combustion
- Dispositif de sécurité DSA (soupape DSA optionnelle)
- Komplet aus Stahl gebaut
- Feuerraumverkleidung aus Gusseisen und aus Stahl
- Vertikal schließende Tür - öko
- Große Kohlenbecken aus Gusseisen
- Verstellbare Primär und Sekundärluft, voraustarierte Tertiärluft mit Nachverbrennungssystem
- Sicherheitsvorrichtung DSA (DSA Sicherheitsventil OPTIONAL)
- Totalmente de acero
- Hogar de fundición y acero
- Cristal retráctil
- Amplio brasero de fundición de grande espesor
- Aire primaria y secundaria regulable, aire terciaria con sistema de postcombustion precalibrado
- Dispositivo de seguridad DSA (válvula DSA opcional)

### DATI TECNICI

 846x1585-1625x667	 8,0
 287	 200
 650x325	 64 L
 558x410x400	<b>bar</b> 2,5
<b>%</b> 76,5	

### TECNOLOGIA

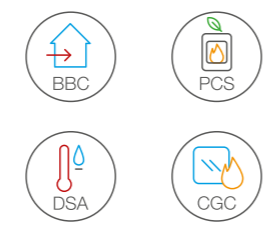

**CONTO TERMICO**  
Per maggiori informazioni consultare il nostro sito:  
[www.lanordica-extraflame.com](http://www.lanordica-extraflame.com)









## TERMOCAMINO WF PLUS DSA

**A+** | 20,5 kW-N | 11,3 kW-H<sub>2</sub>O | 587 m<sup>3</sup>

### PLUS

- Costruito interamente in acciaio
- Focolare in ghisa e Nordiker
- Vetro a scomparsa
- Ampio braciere in ghisa di grosso spessore
- Aria primaria e secondaria regolabile, aria terziaria prearata con sistema di post combustione
- Dispositivo di sicurezza DSA (valvola DSA optional)
- Carter coibentato
- Completely made of steel
- Hearth in cast iron and Nordiker
- Disappearing glass
- Thick cast iron large brazier
- Adjustable primary and secondary air, preset tertiary air with post combustion system
- DSA security device (DSA valve not included)
- Insulated guard
- Entièrement en acier
- Foyer en fonte et Nordiker
- Vitre escamotable
- Grand brasier en fonte de grande épaisseur
- Air primaire et secondaire réglables, air tertiaire pré-calibré avec système post combustion
- Dispositif de sécurité DSA (soupape DSA optionnelle)
- Carter isolé
- **Flamme Verte: Appareil de class 7★**
- Komplet aus Stahl gebaut
- Feuerraumverkleidung aus Gusseisen und aus Nordiker
- Vertikal schließende Tür - öko
- Große Kohlenbecken aus Gusseisen
- Verstellbare Primär und Sekundärluft, voraustarierte Tertiärluft mit Nachverbrennungssystem
- Sicherheitsvorrichtung DSA (DSA Sicherheitsventil OPTIONAL)
- Isoliertes Gehäuse
- Totalmente de acero
- Hogar de fundición y Nordiker
- Cristal retráctil
- Amplio brasero de fundición de grande espesor
- Aire primaria y secundaria regulable, aire terciaria con sistema de postcombustion precalibrado
- Dispositivo de seguridad DSA (válvula DSA opcional)
- Isoliertes Gehäuse

### DATI TECNICI

 846x1585-1625x667	 5,4
 334	 200
 558x275	 64 L
 590x365x400	<b>bar</b> 2,5
<b>%</b> 85,5	

### CERTIFICAZIONI



### TECNOLOGIA

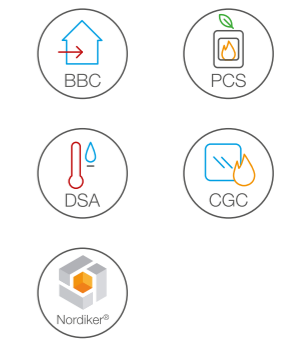



## CALDAIE

Le caldaie a legna LNK si contraddistinguono per la loro versatilità, per la facilità di utilizzo e per la loro durata nel tempo. Le prestazioni di assoluto rilievo, sia in termini di potenza che di rendimento, sono accompagnate a una particolare attenzione per le emissioni nell'ambiente che permettono ad ogni utente di ottenere un grande risparmio economico ed un comfort ideale nella propria abitazione.

### CENTRAL HEATING:

The new wood burning boilers LNK stand out for versatility, ease-of-use and durability. The excellent power output and efficiency performance are accompanied by special attention to emissions into the environment, thus allowing each user to save and providing ideal comfort in the home.

### CHAUDÉRE:

Les nouvelles chaudières à bois LNK se caractérisent par leur polyvalence, leur facilité d'utilisation et leur durabilité. Les excellentes prestations, aussi bien en termes de puissance que de rendement, sont accompagnées par une attention particulière accordée pour les émissions dans l'environnement qui permettent à chaque utilisateur d'obtenir une économie d'énergie importante et un confort idéal dans sa propre maison.

### KASSEL:

Die neuen Holzkessel LNK zeichnen sich aus durch Vielseitigkeit, einfache Bedienung und lange Lebensdauer. Die bemerkenswerten Leistungen gehen mit einem besonderen Bewusstsein für die Reduzierung der Schadstoffemissionen einher und ermöglichen jedem Benutzer optimalen Komfort in der Wohnung bei niedrigeren Heizkosten.

### CALDERAS:

Las nuevas calderas de leña LNK se distinguen por su versatilidad, su duración y son fáciles de usar. Las prestaciones excelentes, tanto en términos de potencia, como en términos de rendimiento y la especial atención prestada a las emisiones en el medio ambiente, permiten a cada usuario obtener un significativo ahorro en términos económicos y un confort ideal en su casa.





# CALDAIE A LEGNA LNK

Central Heatings LNK / Chaudière LNK / Kessel LNK / Calderas LNK

**CONTO TERMICO**  
  
 Per maggiori informazioni consultare il nostro sito:  
[www.lanordica-extraflame.com](http://www.lanordica-extraflame.com)



**LNK15**

17,3 kW - 495 m<sup>3</sup> riscaldabili



**LNK20**

21 kW - 602 m<sup>3</sup> riscaldabili



**LNK30**

29 kW - 831 m<sup>3</sup> riscaldabili



**LNK40**

37 kW - 1060 m<sup>3</sup> riscaldabili

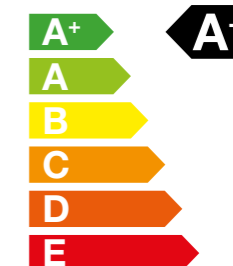

## CERTIFICAZIONI

15a B-VG

BImSchV



LNK15 AE5-P-086  
 LNK20 AE5-P-087  
 LNK30 AE5-P-088  
 LNK40 AE5-P-089  
[certificazioneariapulita.it](http://certificazioneariapulita.it)

## PLUS

- Costruite in acciaio da 6mm di spessore.
- Ventilatore fumi modulante elettronicamente.
- Totalmente isolate termicamente.
- Sportello dedicato per rapida e pratica accensione.
- Display digitale di facile gestione che visualizza e comanda le funzioni.
- Facili da pulire.
- Made with 6 mm thick steel.
- Electronically modulating smoke fan.
- Fully insulated.
- Door for quick and convenient switch-on.
- Easy to manage digital display that shows and commands the functions.
- Easy to clean.
- Fabriquées en acier de 6 mm d'épaisseur.
- Ventilateur des fumées .électroniquement modulant.
- Totalement isolées thermiquement.
- Trappe dédiée à un allumage pratique et rapide.

- Écran numérique facile à gérer qui affiche et commande les fonctions.
- Faciles à nettoyer.
- Flamme Verte: Appareil de class 7★
- Aus 6 mm starkem Stahl hergestellt.
- Elektronisch modulierender Rauchventilator.
- Thermisch vollkommen isoliert.
- Klappe für rasches und praktisches Anzünden.
- Digital-Display mit einfacher Bedienung, auf dem die Funktionen angezeigt und gesteuert werden.
- Leicht zu reinigen.
- Fabricadas con acero de 6 mm de espesor.
- Ventilador de humos modulado electrónicamente.
- Totalmente aisladas térmicamente.
- Puerta específica para un encendido rápido y práctico.
- Pantalla digital fácil de gestionar que muestra y controla las funciones.
- Fáciles de limpiar.

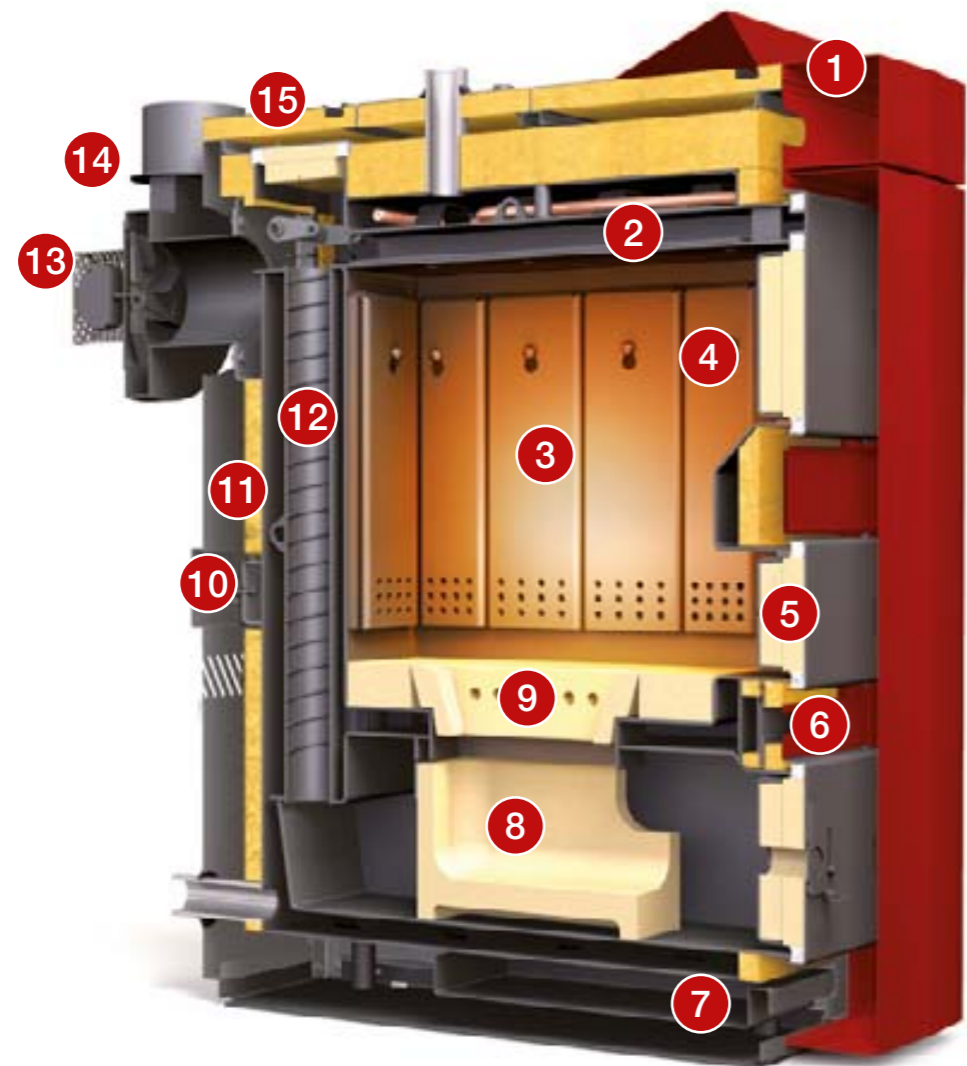

## TECNOLOGIA

**[1] Display digitale** per una facile gestione e controllo delle funzioni della caldaia.

**[2] Sistema di aspirazione dei gas della combustione** che impedisce la fuoriuscita di fumi durante le operazioni di ricarica (si attiva agendo sul display prima dell'apertura della porta).

**[3] Profili in acciaio rimovibili** per la protezione interna della caldaia per una garanzia di lunga durata.

**[4] Ampio vano di carico** per il caricamento di ceppi lunghi fino a mezzo metro per una combustione di lunga durata.

**[5] Sportello dedicato** per facilitare e semplificare le operazioni di accensione e pulizia. La portina di accensione consente infatti di accedere direttamente alla base del vano di carico.

**[6] Valvola dell'aria secondaria** con semplice regolazione manuale per garantire che nella camera di combustione giunga sempre la quantità d'aria ideale per la combustione.

**[7] Cassetto cenere frontale** per una facile rimozione delle ceneri da combustione. Nessuna apertura laterale per la pulizia quindi minore ingombro per l'installazione.

**[8] Camera di combustione** in cemento refrattario con sistema di gassificazione a fiamma inversa ad alta temperatura per eccellenti valori di combustione che corrispondono ad alti rendimenti e basse emissioni.

**[9] Ugello** in cemento refrattario.

**[10] Valvola dell'aria primaria** per garantire che nella camera di combustione giunga sempre la quantità d'aria ideale per la combustione.

**[11] Isolamento termico** efficiente dei rivestimenti per perdite ridotte di calore.

**[12] Scambiatori di calore a fascio tubiero e turbolatori con sistema di pulizia manuale** azionabile tramite una comoda leva. Grazie al comodo sistema di pulizia delle superfici dello scambiatore si garantisce un elevato grado di rendimento con una conseguente riduzione del consumo di combustibile. La leva di pulizia può essere montata a destra o a sinistra a seconda dello spazio e delle preferenze.

**[13] Estrattore fumi** a velocità variabile gestito elettronicamente e con la possibilità di monitoraggio dal display per una massima sicurezza di funzionamento.

**[14] Raccordo del gas di scarico con rotazione di 180°** per facilitare le operazioni di installazione.

**[15] Sportello per la pulizia dei turbolatori.**

## ❶ DATI TECNICI - TECHNICAL DATA

		LNK15	LNK20	LNK30	LNK40
Dimensioni L x H x P	mm	599x1310x1293	599x1310x1293	695x1310x1293	695x1310x1293
Peso netto	Kg	465	465	519	524
Diametro scarico fumi	Ø mm	150	150	150	150
m³ riscaldabili ***	m³	495	602	831	1060
kW-M Potenza termica globale	kW	19,4	23,5	32,2	40,9
kW-N Potenza termica nominale	kW	17,3	21	29	37
Contenuto fluido scambiatore	L	72	72	91,6	90,2
Capacità serbatoio legna	dm³	89	89	119	119
bar Pressione d'esercizio max	bar	2,5	2,5	2,5	2,5
Temperatura ottimale d'esercizio	°C	85°	85°	85°	85°
Allacciamento caldaia - T2, T3	"	1 ½	1 ½	1 ½	1 ½
% Rendimento	%	89	89,3	89,9	90,5
Consumo orario**	kg/h	4,5	5,4	7,4	9,2
Tiraggio canna fumaria	Pa	10-15	10-15	10-15	10-15
Presa aria esterna	cm²	100	100	100	100
Lunghezza massima legna	cm	50	50	50	50
W Assorbimento elettrico	W	28	33	43	52
Diametro tubo scarico automatico	"	¾	¾	¾	¾

(\*\*) Il consumo è calcolato in base al rapporto kW-N/Rendimento con uso di legna avente PCI (potere calorico inferiore) pari a 4,3 kWh/kg. / Consumption is based on the kW-N/Performance ratio using wood with an LCV (lower calorific value) of 4.3 kWh/kg. / La consommation est calculée en fonction du rapport kW-N/Rendement avec utilisation d'un bois ayant un PCI (pouvoir calorifique inférieur) égal à 4,3 kWh/kg. / Der Verbrauch wird auf Grundlage des Verhältnisses kW-N/Leistung bei Verwendung von Holz mit einem Hu (unterer Heizwert) von 4,3 kWh/kg berechnet. / El consumo se calcula sobre la base de la relación kW-N/Rendimiento con el utilizzo de madera con PCI (poder calorífico inferior) de 4,3 kWh/kg.

(\*\*\*) NB: Riferito al fabbisogno di 30 kcal/h x m³ / Referred to the need of 30 kcal/h x m³ / Par rapport à un besoin de 30 Kcal/h x m³ / Bezogen auf einen Bedarf von 30 Kcal/h x m³ / Referido a la necesidad de 30 kcal/h x m³

## 🕒 DIMENSIONI - DIMENSIONS (mm)

	LNK15	LNK20	LNK30	LNK40
A	522	522	618	618
B	599	599	695	695
C	1310	1310	1310	1310
D	255	255	351	351
E	559	559	559	559
F	102	102	102	102
G	172	172	220	220
H	1293	1293	1293	1293
I	904	904	904	904
J	257	257	257	257
K	148	148	148	148
L	135	135	135	135
M	100	100	100	100
N	261	261	309	309
O	336	336	384	384
P	1172	1172	1172	1172
R	88	88	88	88
S	6/4"	6/4"	6/4"	6/4"
T	1/2"	1/2"	1/2"	1/2"

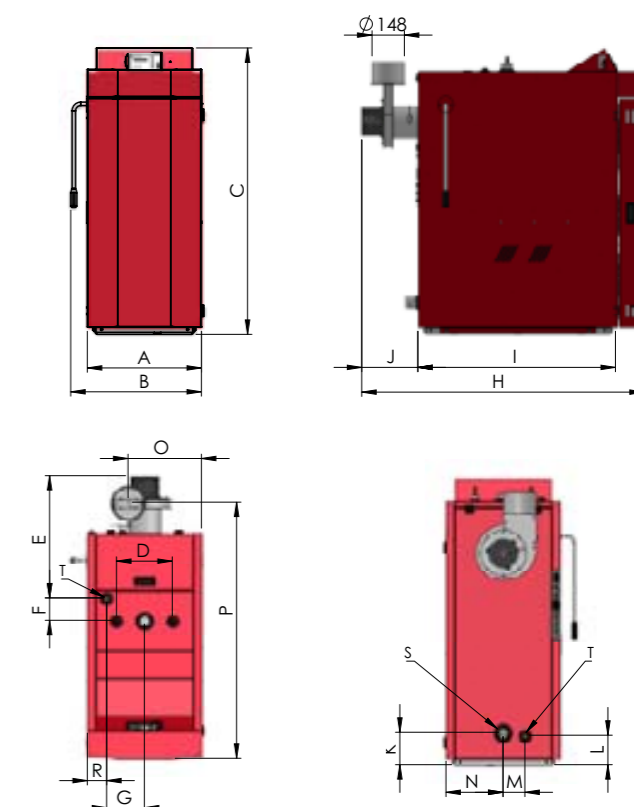

# L'importanza di affidarsi al tecnico specializzato per la scelta della caldaia o di un termoprodotto.

Solo a titolo di generica informazione, di seguito segnaliamo le principali informazioni che si devono avere per una scelta consapevole dell'apparecchio:

- Fabbisogno termico dell’abitazione
- Tipologia di impianto di riscaldamento presente: radiatori, ventilconvettori o pannelli radianti
- Tipologia del sistema di distribuzione: mono-tubo, bi-tubo o collettori
- Indicazione se, oltre al riscaldamento, la caldaia è destinata anche alla produzione di acqua calda sanitaria
- Eventuale predisposizione o l'installazione di collettori solari termici
- Tipologia di accumulo più adatta: bollitore sanitario o puffer
- Presenza di un sistema anticondensa

Per questo è importante affidarsi alla consulenza di un tecnico specializzato, in grado di effettuare una precisa analisi dell’impianto, di fornire i chiarimenti agli eventuali quesiti anche sotto l’aspetto dei requisiti normativi di installazione e di consigliare la tipologia di caldaia più adatta.

Un sistema progettato correttamente garantisce quindi:

- la completa sicurezza della propria casa
- un comfort ottimale
- elevato rendimento del generatore di calore
- massimo risparmio
- minor usura dei componenti e quindi maggiore durata di vita dell'apparecchio

## IMPORTANTE

Le caldaie a legna devono funzionare in modo continuo e senza interruzioni. Di conseguenza deve essere tassativamente evitato il sovradimensionamento della caldaia che causerebbe una frequente interruzione della combustione. Le interruzioni forzate della combustione producono una maggiore fumosità, con conseguente intasamento del camino e della caldaia, un minor rendimento e una riduzione della durata della caldaia stessa.

## It is important to seek the guidance of a qualified technician who is able to recommend the most suitable type of boiler or heating device.

By way of providing generic information, we highlight below the main information one must have in order to make an informed decision when choosing an appliance:

- Thermal requirements of the home
- Type of existing heating system: radiators, fan coil units, or radiant panels
- Type of distribution system: one-pipe, two-pipe or manifolds
- Indication of whether, in addition to heating, the boiler is also intended for the production of domestic hot water
- Any set-up for or installation of thermal solar collectors
- Most suitable type of storage: DHW storage tank or puffer

Accordingly, it is important to seek the guidance of a qualified technician who is able to perform a precise analysis of the system, provide explanations to any questions, including regulation requirements for installation, and recommend the most suitable type of boiler.

A correctly designed therefore guarantees:

- complete safety of one’s home
- maximum comfort
- high yield of heat generator
- maximum savings
- less wear to the parts and therefore longer service life of the appliance

## IMPORTANT

Wood central heatings are to operate continuously and without interruptions.

As a result, the oversize of the central heating is to be strictly forbidden, which could cause a frequent interruption of the combustion. Forced interruptions of the combustion produce a higher grade of smoke, with the resulting obstruction of the chimney, a lower yield and the reduction in the central heating life.

## L’importance de faire confiance au technicien spécialisé pour le choix de la chaudière ou d’un thermoproduit.

Uniquement à titre d’information générale, nous signalons ci-dessous les principales informations que l’on doit avoir pour un choix conscient de l’appareil:

- Besoins thermiques de la maison
- Typologie d’installation de chauffage présente: radiateurs, ventilo-convecteurs ou panneaux chauffants
- Typologie du système de distribution: mono-tube, bi-tube ou collecteurs

- Indication si, en plus du chauffage, la chaudière est destinée également à la production d’eau chaude sanitaire
- Éventuelle prédisposition ou l’installation de collecteurs solaires thermiques
- Typologie d’accumulation qui est la plus adaptée: chauffe-eau sanitaire ou puffer

Pour ceci il est important de faire confiance aux conseils d’un technicien spécialisé, capable d’effectuer une analyse précise de l’installation, de fournir les éclaircissements aux questions concernant les conditions de réglementation d’installation et de conseiller le type de chaudière la plus adaptée.

Un système conçu correctement garantit donc:

- la totale sécurité de sa maison
- un confort optimal
- un rendement élevé du générateur de chaleur
- économie maximale
- moins d’usure des composants et par conséquent une durée de vie plus longue de l’appareil

## IMPORTANT

Les chaudières à bois doivent fonctionner de façon continue et sans aucun arrêt.

Par conséquent, il faut éviter tout surdimensionnement de la chaudière qui provoquerait un arrêt fréquent de la combustion. Les arrêts forcés de la combustion produisent plus de fumée, entraînant ainsi une obstruction de la cheminée et de la chaudière, un rendement moindre et une réduction de la durée de la chaudière.

## So wichtig ist es, sich bei der Wahl des Heizkessels oder eines Heizgeräts an einen Fachtechniker zu wenden.

Lediglich als allgemeinen Hinweis nennen wir im Folgenden die wesentlichen Informationen, die bei einer verantwortungsbewussten Gerätewahl benötigt werden:

- Wärmebedarf der Wohnung
- Art der vorhandenen Heizungsanlage:Radiatoren, Gebläsekonvektoren oder Fußbodenheizung
- Art des Verteilungssystems: Einrohr, Zweirohr oder Kollektor
- Hinweis darauf, ob der Heizkessel außer zum Heizen auch zur Produktion von Brauchwarmwasser bestimmt ist.
- Etwaige Vorbereitung oder Installation von thermischen Sonnenkollektoren
- Am besten geeigneter Speichertyp: Brauchwasserboiler oder Puffer

Darum ist es wichtig, sich von einem Fachtechniker beraten zu lassen, der eine präzise Anlagenanalyse vornehmen kann, Erklärungen zu etwaigen Anforderungen - auch hinsichtlich der Installationsbestimmungen - bietet und in der Lage ist, den geeigneten Heizkesseltyp zu empfehlen.

Ein korrekt entworfenes Heizkesselanlagensystem gewährleistet somit:

- Die vollkommene Sicherheit im eigenen Heim
- Einen optimalen Komfort
- Einen hohen Wirkungsgrad des Wärmeerzeugers
- Maximale Ersparnis
- Geringere Abnutzung der Bauteile und somit längere Haltbarkeit des Geräts

## WICHTIG

Die Heizkessel für Holz müssen konstant und ohne Unterbrechungen laufen.

Deshalb muss die Überdimensionierung des Heizkessels streng verboten werden, da sie zu häufigen Unterbrechungen der Verbrennung führt. Die Zwangsunterbrechungen der Verbrennung führen zu einer höheren Verrauchung mit folgender Verstopfung des Kamins und des Heizkessels, einer geringeren Leistung und einer Reduzierung der Lebensdauer des Heizkessels.

## La importancia de confiar en un técnico especializado para elegir la caldera o un termoproducto.

A título de información general, incluimos a continuación la información principal que debe tenerse en cuenta para elegir adecuadamente el aparato:

- Demanda térmica de la vivienda.
- Tipo de instalación de calefacción presente: radiadores, ventilconvectores o paneles radiantes.
- Tipo de sistema de distribución: monotubo, bitubo o colectores.
- Indicación de si la caldera, además de estar destinada a la calefacción, servirá para la producción de agua caliente sanitaria.
- Eventual preparación o instalación de colectores solares térmicos.
- El tipo de acumulador que resulta más adecuado: calentador sanitario o puffer.

Por ello es importante buscar el asesoramiento de un técnico especializado, capaz de realizar un análisis preciso de la instalación, de proporcionar las aclaraciones oportunas, incluso desde el punto de vista de los requisitos normativos de instalación, y de aconsejar al cliente sobre el tipo de caldera más idóneo.

Por tanto, un sistema proyectado correctamente garantiza:

- la completa seguridad de la casa
- un óptimo confort
- un elevado rendimiento del generador de calor
- máximo ahorro
- menor desgaste de los componentes y, consiguientemente, mayor duración de la vida útil del aparato.

## IMPORTANTE

Las calderas de leña tienen que funcionar de forma continua y sin interrupciones.

Por consiguiente, tiene que evitarse terminantemente sobredimensionar la caldera, porque causaría una interrupción frecuente de la combustión. Las interrupciones forzadas de la combustión producen una mayor emisión de humos, con la consiguiente obstrucción de la chimenea y de la caldera, un menor rendimiento y una reducción de la duración de la caldera.

## ACCESSORI

La Nordica-Extraflame, per accontentare anche i clienti più esigenti, ha arricchito i propri prodotti di importanti accessori.

### ACCESSORIES:

La Nordica-Extraflame in order to satisfy even the most demanding customers has enhanced its product range with important accessories.

### ACCESSOIRES:

Dans le but de satisfaire aussi la clientèle plus exigeante, La Nordica-Extraflame a enrichi ses produits avec d'importants accessoires.

### ZUBEHÖRE:

Um sogar ihre sehr wählerischen Kunden zufrieden zu stellen, hat La Nordica-Extraflame ihre Produkte um wichtige Zubehöre bereichert.

### ACCESORIOS:

Con el fin de satisfacer también los clientes más exigentes, La Nordica-Extraflame ha enriquecido sus productos con unos importantes accesorios.



Kit acqua calda sanitaria per ThermoProdotto\*  
Sanitary water KIT for ThermoProducts\*  
Kit eau chaude sanitaire pour ThermoProduits\*  
ACS Kit für Sanitärwassererzeugung für ThermoProdukte\*  
Kit agua caliente sanitaria para ThermoProductos\*

**N.B.:** verificare la potenza dell'apparecchio  
**IMPORTANT:** check the appliance power  
**N.B.:** Vérifier la puissance de l'appareil  
**N.B.:** Die Leistung des Geräts überprüfen  
**NOTA:** compruebe la potencia del aparato



Kit separatore impianto idraulico A/C 2.0  
(non abbinabile alla Caldaia LNK40)  
Water separator kit 2.0  
(not compatible with Boiler LNK40)  
Kit séparateur installation idraulique A/C 2.0  
(non compatible avec la Chaudière LNK40)  
Separator-Kit 2.0  
(nicht mit dem Heizkessel LNK40 kombinierbar)  
Kit separador instalacion hydraulica A/C 2.0  
(no puede combinarse con la Caldera LNK40)

**N.B.:** si consiglia una valutazione preventiva sul corretto dimensionamento attraverso un progettista.  
**IMPORTANT:** it is recommended to have a design engineer assess the correct sizing in advance.  
**N.B.:** il est recommandé de faire une évaluation préventive sur le bon dimensionnement par un capteur.  
**N.B.:** Es wird empfohlen, zuvor von einem Planer eine Bewertung für die korrekten Größe ausführen zu lassen.  
**NOTA:** se recomienda realizar un estudio previo del dimensionamiento correcto, con un diseñador.



Regolatore ThermoProdotti Digitale  
Controller for thermoproducts  
Régulateur numérique Thermoproducts  
Digitale Steuerung für ThermoProdukte  
Regulador digital para Thermo Productos



Scambiatore 20 piastre inox  
20 Plate exchanger inox  
Echangeur 20 plaques inox  
20 Platten-Wärmetauscher inox  
Intercambiador 20 placas inox



Scambiatore 30 piastre inox  
30 Plate Exchange inox  
Echangeur 30 plaques inox  
30 Platten-Wärmetauscher inox  
Intercambiador 30 placas inox



Valvola automatica sfogo aria scarico laterale  
Automatic lateral vent valve  
Vanne autom. ouverture air décharge latéral  
Automatisches seitliches Entlüftungsventil  
Valvula automatica de descarga aire lateral



Optional Accessories - Accessoires Optionnel - Zubehör auf Anfrage - Accesorios Optional

Valvola sicurezza 1,5 bar c/membrana EPM  
Membrane Safety Valve, 1,5 bar  
Vanne de sécurité 1,5 bar avec membrane EPM  
Membran-Sicherheitsventil 1,5 bar  
Valvula de seguridad 1,5 bar con membrana EPM



Valvola sicurezza 3,0 bar c/membrana EPM  
Membrane Safety Valve, 3 bar  
Vanne de sécurité 3,0 bar avec membrane EPM  
Membran-Sicherheitsventil 3 bar  
Valvula de seguridad 3,0 bar con membrana EPM

Pozzetto applicaz. term. controllo 1/2"  
Heat sump 1/2"  
Plongeur pour application therm. controle 1/2"  
Oelwanne 1/2"  
Vaina applicaz.term.controllo 1/2"



Valvola a 3 vie motorizzata da 3/4"  
Three-way valve 3/4"  
Vanne à 3 voies motorisée 3/4"  
Dreiwegeventil 3/4"  
Valvula 3 vias motorizada con 3/4"



Flussostato  
Flow sensor  
Flussostat  
Durchflussmesser  
Fluxostato



Valvola automatica di scarico termico DSA per ThermoProdotti alimentati da combustibili solidi. Attacco 3/4" femmina  
Automatic DSA temperature relief valve, 3/4" female nut connection  
Vanne automatique de décharge thermique DSA pour combustibles solides. Connection 3/4" femme.  
Automatisches DSA Ablassventil  
Valvula automatica de descargue tèrmico DSA. Enchufe 3/4 hembra



Valvola miscelatrice anticondensa per circuito di ricircolo 55°C attacco 1"  
Anti-condensation mixer valve for 55°C recirculation circuit 1" connection  
Vanne mélangeuse anti-condensation pour circuit de recirculation 55°C raccord 1"  
Antikondensationsmischventil für Rückführungskreislauf 55°C Anschluss 1"  
Válvula mezcladora anticondensación para circuito de recirculación 55°C sujeción 1"



Valvola miscelatrice anticondensa per circuito di ricircolo 60 °C attacco 1" Disponibile per: Caldaie Serie LNK  
60°C,1" Anticondensation mixing valve for boiler up to 150 kW Available for: LNK Boilers series  
Vanne mélangeuse anti-condensation pour circuit de recirculation 60°C raccord 1" Disponible pour: Chaudières Série LNK  
Antikondensationsmischventil für Rückführungskreislauf 60°C, 1" Erhältlich für: Kessel LNK Serie  
Válvula mezcladora anti-condensación para circuito de recirculación 60°C conexión 1" para potencias de hasta 150 kW Disponible para: Serie LNK Calderas

Scatola parete bianca. Adatta per: • Regolatore Inerti • Regolatore ThermoProdotti digitale  
White wall box: Suitable for: • Inserts control unit • Thermo-products digital control unit  
Boîtier mural blanc. Adapté pour: • Régulateur pour inserts • Régulateur numérique ThermoProduits  
Weiße Wandabdeckung. Geeignet für: • Einsätze Regler • digitalen ThermoProdukte-Regler  
Caja pared blanca. Apta para para: • Regulador Empotrables • Regulador ThermoProductos



## ACCESSORI VENTILAZIONE

Anello Ø 150mm supplementare ventilazione monoblocco / raccordo aria  
Monoblock / air fitting ventilation additional Ø 150mm ring  
Bague Ø 150mm supplémentaire ventilation monobloc / raccord air  
Zusätzlicher Ring Ø 150mm, Monoblock Belüftung / Luftanschluss  
Aro Ø 150mm suplementario ventilación monobloque / racor de aire



Anello Ø 120mm supplementare ventilazione monoblocco / raccordo aria  
Monoblock / air fitting ventilation additional Ø 120mm ring  
Bague Ø 120mm supplémentaire ventilation monobloc / raccord air  
Zusätzlicher Ring Ø 120mm, Belüftung Monoblock / Luftanschluss  
Aro Ø 120 mm suplementario para ventilación monobloque / racor de aire



Anello Ø 100 mm raccordo aria. Disponibile per:  
Air fitting Ø 100 mm ring. Available for:  
Bague Ø 100 mm raccord air. Disponible pour:  
Ring Ø 100 mm Luftanschluss. Erhältlich für:  
Aro Ø 100 mm racor de aire. Disponible para:



• Fedora • TermoRossella Plus EVO DSA • TermoNicoletta EVO DSA • TermoNathalie DSA

Bocchetta ventilazione regolabile bianca Ø 120 mm dim. 150x150 mm  
White adjustable ventilation outlet Ø 120mm dimensions 150x150mm  
Goulotte ventilation réglable blanche Ø 120mm dimension 150x150mm  
Lüftungsgitter regulierbar weiß Ø 120mm Maße 150x150 mm  
Rejilla de ventilación regulable blanca Ø 120mm dimensiones 150x150 mm



Bocchetta ventilazione regolabile bianca Ø 150 mm dim. 175x175 mm  
White adjustable ventilation outlet Ø 150mm dimensions 175x175mm  
Goulotte ventilation réglable blanche Ø 150mm dimension 175x175mm  
Lüftungsgitter regulierbar weiß Ø 150mm Maße 175x175 mm  
Rejilla de ventilación regulable blanca Ø 150mm dimensiones 175x175 mm



Bocchetta ventilazione regolabile bianca Ø 150 mm dim. 175x350 mm.  
Bocchetta combinata aria forzata e convezione naturale  
White adjustable ventilation outlet Ø 150mm.  
Dimensions 175x350mm. Combined forced air and natural convection outlet  
Goulotte ventilation réglable blanche Ø 150mm dimension 175x350mm.  
Goulotte combinée ventilation forcée et convention naturelle  
Lüftungsgitter regulierbar weiß Ø 150mm Maße 175x350 mm.  
Kombinierter Rohstutzen Zwangsluft und natürliche Konvektion  
Rejilla de ventilación regulable blanca Ø 150mm dimensiones 175x350 mm.  
Rejilla combinada para aire forzado y convección natural



Bocchetta ventilazione bianca dim. 120x230 mm  
White ventilation outlet dimensions 120x230mm  
Goulotte ventilation blanche dimension 120x230mm  
Lüftungsgitter weiß Maße 120x230mm  
Rejilla de ventilación blanca dimensiones 120x230 mm



## KIT "WIND AIR"

Kit "Wind Air" per due punti aria, completo di accessori ed escluso diffusori. Disponibile per i prodotti della linea inserti, focolari e monoblocchi.

- Il kit include:
- centralina regolazione digitale
  - scatola parete bianca di supporto per centralina
  - 2 gruppi motore
  - 2 angolari di supporto per gruppi motore
  - 2 anelli raccordo aria, Ø 120 mm
  - 2 Tubi alluminio graffiato L. 1500 mm, Ø 120 mm
  - 4 Fascette stringitubo inox Ø 60-175

"Wind Air" kit for two air points, complete with accessories and excluding diffusers. Available for the inserts, fireplaces and monoblocks line products.

- The kit includes:
- digital adjustment control unit
  - white wall support box for control unit
  - 2 motor units
  - 2 support brackets for motor units
  - 2 air fitting rings, Ø 120 mm
  - 2 Crimped aluminium pipes L. 1500 mm, Ø 120 mm
  - 4 Stainless steel pipe clamps Ø 60-175

Kit "Wind Air" para dos puntos de aire, con accesorios y excluidos los difusores. Disponible para los productos de la línea empotrables, hogares y monobloques.

- El kit incluye:
- centralita de regulación digital
  - caja con pared blanca de soporte para centralita
  - 2 grupos motor
  - 2 angulares de soporte para grupos motor
  - 2 anillos rácor aire, Ø 120 mm
  - 2 Tubos aluminio estriado L. 1500 mm, Ø 120 mm
  - 4 Abrazaderas de acero inoxidable Ø 60-175

Regolatore supplementare per il controllo di una bocchetta del kit Wind Air in modo indipendente e la gestione della temperatura in un altro ambiente separato.

Additional controller for controlling a Wind Air kit nozzle independently and managing the temperature in another separate room.

Régulateur supplémentaire pour le contrôle d'une bouche du kit Wind Air de manière indépendante et la gestion de la température dans un autre environnement séparé.

Zusätzlicher Regler für die unabhängige Steuerung einer Öffnung des Bausatzes Wind Air und zur Temperaturregelung in einem anderen getrennten Raum.

Regulador suplementario para controlar una boca del kit Wind Air en modo independiente y la gestión de la temperatura en otro ambiente separado.



Diffusore Shade per sistema "Wind Air" a regolazione fissa. Bianco lucido  
Shade diffuser for fixed setting "Wind Air" system. Glossy white  
Diffuseur Shade pour système « Wind Air » à réglage fixe. Blanc brillant  
Diffusor Shade für "Wind Air"-System mit fester Einstellung. Glänzend weiß  
Difusor Shade para sistema "Wind Air" con regulación fija. Blanco brillante



Diffusore Wave per sistema "Wind Air" a regolazione fissa. Bianco gofrato  
Wave diffuser for fixed setting "Wind Air" system. Embossed white  
Diffuseur Wave pour système « Wind Air » à réglage fixe. Blanc gaufré  
Diffusor Wave für "Wind Air"-System mit fester Einstellung. Geprägtes Weiß  
Difusor Wave para sistema "Wind Air" de regulación fija. Blanco gofrado



Kit "Wind Air" pour deux points air, accessoires fournis et diffuseurs exclus. Disponible pour les produits de ligne inserts, cheminées et monoblocs.

- Le kit comprend:
- unité centrale de réglage numérique
  - boîtier mural blanc de support pour l'unité centrale
  - 2 groupes moteur
  - 2 supports angulaires pour groupes moteur
  - 2 bagues raccord air, Ø 120 mm
  - 2 Tubes aluminium annexé L. 1500 mm, Ø 120 mm
  - 4 Colliers de serrage inox Ø 60-175

Bausatz "Wind Air" für zwei Luftpunkte, komplett mit Zubehör und ohne Diffusoren. Erhältlich für die Produkte der Serie Einsätze, Feuerstellen und Monoblöcke.

- Der Bausatz enthält:
- Einstellbares Digital-Steuergerät
  - Wandgehäuse Weiß zur Halterung für Steuergerätes
  - 2 Motoreinheiten
  - 2 Stützwinkel für Motoreinheiten
  - 2 Luftanschlussringe, Ø 120 mm
  - 2 Abgekantete Aluminiumrohre L 1500 mm, Ø 120 mm
  - 4 Rohrschellen Inox 4 Ø 60-175

## ACCESSORI INSERTI E FOCOLARI

Fascetta stringitubo inox Ø 60-175  
Stainless steel pipe clamp Ø 60-175  
Rohrschelle Inox 60-175  
Collier de serrage inox Ø 60-175  
Abrazadera de acero inoxidable Ø 60-175



Tubo alluminio graffato L. 1500 mm Ø 100 mm  
Crimped aluminium pipe L. 1500 mm Ø 100 mm  
Tube aluminium annexé L. 1500 mm Ø 100 mm  
Abgekantetes Aluminiumrohr, L. 1500 Ø 100  
tubo de aluminio estriado L. 1500 mm Ø 100 mm



Tubo alluminio graffato L. 1500 mm Ø 120 mm  
Crimped aluminium pipe L. 1500 mm Ø 120 mm  
Tube aluminium annexé L. 1500 mm Ø 120 mm  
Abgekantetes Aluminiumrohr, L. 1500 mm Ø 120 mm  
Tubo de aluminio estriado L. 1500 mm Ø 120 mm



Tubo alluminio graffato L. 1500 mm Ø 150 mm  
Crimped aluminium pipe L. 1500 mm Ø 150 mm  
Tube aluminium annexé L. 1500 mm Ø 150 mm  
Abgekantetes Aluminiumrohr, L. 1500 mm Ø 150 mm  
tubo de aluminio estriado L. 1500 mm Ø 150 mm



Kit cornici. Disponibile per:  
Surroundings kit. Available for:  
Kit cadres. Disponible pour:  
Bausatz Rahmen. Verfügbar für:  
kit de marcos. Disponible para:



- Inserto 60 - Ventilato
- Inserto 60 4.0 - Ventilato
- Inserto 70 - Ventilato
- Inserto 70 4.0 - Ventilato
- Inserto 70 4.0 Tondo - Ventilato
- Inserto 70 L - Ventilato
- Inserto 70 L 4.0 - Ventilato
- Inserto 70 H49 - Ventilato
- Inserto 70 H49 4.0 - Ventilato

Kit Cornice Inserti Wide. Disponibile per:  
Kit frame Inserts Wide. Available for:  
Kit cadre inserts Wide. Disponible pour:  
Verkleidung für Einsätze Wide. Verfügbar für:  
Kit de marco inserciones Wide. Disponible para:

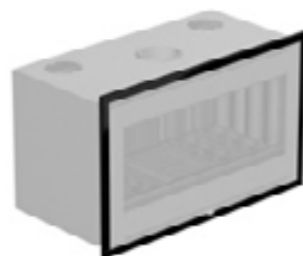

- Inserto 70 Wide
- Inserto 70 PRS Wide
- Inserto 80 Wide
- Inserto 80 PRS Wide
- Inserto 100 Wide

Carter optional. Disponibile per:  
Optional guard. Available for:  
Carter optionnel. Disponible pour:  
Option Gehäuse. Verfügbar für:  
Cárter opcional. Disponible para:



- Focolare 60 Piano Evo
- Focolare 70 Piano
- Focolare 70 Piano Evo Crystal

## ACCESSORI INSERTI E FOCOLARI



Kit piedistallo Disponibile per: / Pedestal kit. Available for: / Kit piédestal. Disponible pour:  
kit de pie. Disponible para: / Bausatz Sockel. Verfügbar für:

- Inserto 60 - Ventilato
- Inserto 70 - Ventilato
- Inserto 70 H49 - Ventilato
- Inserto 70 L - Ventilato
- Inserto 50 Verticale Crystal BII - Ventilato
- Inserto 70 Crystal 3 lati
- Inserto 70 Crystal Angolo
- Inserto 70 Crystal - Ventilato
- Inserto 70 Wide
- Inserto 70 PRS Wide
- Inserto 80 Crystal Evo 2.0 - Ventilato
- Inserto 80 High Pressure
- Inserto 80 PRS Crystal
- Inserto 100 Crystal - Ventilato
- Inserto 80 Wide
- Inserto 80 PRS Wide
- Inserto 100 Wide

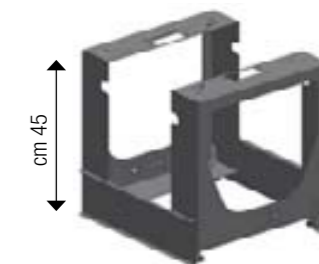

Kit optional aria esterna. Disponibile per:  
/ External air optional kit. Available for: / Kit optionnel air externe. Disponible pour:  
Option Bausatz Außenluft Verfügbar für: / kit opcional aire exterior: disponible para:

- Inserto 50 Verticale Crystal BII
- Inserto 70 Crystal
- Inserto 80 Crystal Evo 2.0
- Inserto 80 PRS Crystal
- Inserto 100 Crystal



Kit ventilazione per Focolare 70-70 Evo, portata del ventilatore a bocca libera 650 mc/h  
Ventilation kit for Hearth 70-70 Evo, fan flow rate with free outlet 650 mc/h  
Kit ventilation pour Focolare (Foyer) 70-70 Evo, capacité du ventilateur à bouche libre 650 mc/h  
Belüftungsbausatz für Focolare 70-70 Evo, Volumenstrom des freiblasenden Ventilators 650 mc/h  
kit de ventilación para hogar 70-70 Evo, caudal del ventilador con salida abierta 650 mc/h



Kit ventilazione per Focolare 60, portata del ventilatore a bocca libera 650 mc/h  
Ventilation kit for Hearth 60, fan flow rate with free outlet 650 mc/h  
Kit ventilation pour Focolare (Foyer) 60, capacité du ventilateur à bouche libre 650 mc/h  
Belüftungsbausatz für Focolare 60, Volumenstrom des freiblasenden Ventilators 650 mc/h  
kit de ventilación para hogar 60, caudal del ventilador con salida abierta 650 mc/h

Kit ventilazione per Monoblocco, portata del ventilatore a bocca libera 650 mc/h. Disponibile per:  
Ventilation kit for Monoblock, fan flow rate with free outlet 650 mc/h Available for:  
Kit ventilation pour Monobloc, capacité du ventilateur à bouche libre 650 mc/h. Disponible pour:  
Belüftungsbausatz für den Monoblock, Volumenstrom des freiblasenden Ventilators 650 mc/h Verfügbar für:  
kit de ventilación para monobloque, caudal del ventilador con salida abierta de 650 mc/h. disponible para:

- Monoblocco Ghisa 750 • Monoblocco Ironker 750 • Monoblocco 800 Angolo



Kit ventilazione, portata del ventilatore a bocca libera 400 mc/h. Disponibile per:  
Ventilation kit, fan flow rate with free outlet 400 mc/h. Available for:  
Kit ventilation capacité du ventilateur à bouche libre 400 mc/h. Disponible pour:  
Belüftungsbausatz, Volumenstrom des freiblasenden Ventilators 400 mc/h Verfügbar für:  
Kit de ventilación caudal del ventilador a boca libre 400 mc/h. disponible para:

- Inserto 60 •Inserto 70 ghisa •Inserto 70 H49 •Inserto 70L\* •Inserto 70L 4.0-ventilato\* •Inserto 70 Crystal •Inserto 70 Crystal 3 Lati •Inserto 70 Crystal Angolo •Inserto 80 Crystal Evo Ventilato •Focolare 80 Bifacciale Hybrid •Inserto 100 Crystal •Focolare 100 bifacciale •Inserto 80 PRS Crystal •Inserto 60 4.0 •Inserto 70 4.0 •Inserto 70 4.0 Tondo •Inserto 70 H49 4.0

\* **N.B.** Per Inserto 70 L / Inserto 70 L 4.0 necessario ulteriore acquisto di nr. 2 anelli Ø 120mm - \* **N.B.** For 70 L Insert additional purchase of 2 rings Ø 120mm - \* **N.B.** : Pour Insert 70 L achat supplémentaire nécessaire de 2 bagues Ø 120mm - \* **N.B.** Für Einsatz 70 L ist eine zusätzliche Anschaffung erforderlich von: 2 Ringen Ø 120mm - \* **NOTA:** Para Empotrable 70 L necesario comprar otros 2 anillos Ø 120mm





## ACCESSORI COTTURA

Girarrosto 60cm con motore elettrico. Disponibile per:  
 Rotisserie 60cm with electric motor. Available for:  
 Tournebrotte 60 cm avec moteur électrique. Disponible pour:  
 Bratspieß 60 cm mit elektrischem Motor. Verfügbar für:  
 Asador 60cm con motor eléctrico. Disponible para:

- TermoCamino WF25 X DSA
- TermoCamino WF PLUS DSA



Griglia inox a 2 moduli lavabili in lavastoviglie. Disponibile per:  
 2 stainless steel grille modules washable in dishwasher. Available for:  
 Grille inox à 2 modules lavables dans lave-vaisselle. Disponible pour:  
 Zweiteiliger Grillrost, spülmaschineneignend. Erhältlich für:  
 Rejilla acero inox. de 2 módulos lavables en lavavajilla. Disponible para:

- America
- Cucinotta



Griglia forno cromata. Disponibile per:  
 Chrome plated oven grille. Available for:  
 Grille four chromée. Disponible pour:  
 Backofenrost verchromt Erhältlich für:  
 Rejilla de horno cromada. Disponible para:

- Rossella Forno - Nicoletta Forno - Romantica 4,5 - Sovrana Evo - Sovrana Easy Evo - Rosa - TermoRosa - TermoRossella Forno - TermoNicoletta Forno - TermoSovrana - Family 4,5
- Rosetta - Rosetta Sinistra - Rosa Reverse - Rosa Sinistra Reverse.



Kit vasca inox 3,5. Disponibile per:  
 3.5 stainless steel tank kit. Available for:  
 Kit cuve inox 3,5. Disponible pour :  
 Bausatz Wasserschiff Edelstahl 3,5. Erhältlich für:  
 Kit cuba acero inox. 3,5. Disponible para:

- Romantica 3,5 - Rosetta - Rosetta Sinistra - Family 3,5



Kit vasca inox 4,5. Disponibile per:  
 4.5 stainless steel tank kit. Available for:  
 Kit cuve inox 4,5. Disponible pour:  
 Bausatz Wasserschiff Edelstahl 4,5. Erhältlich für:  
 Kit cuba acero inox. 4,5. Disponible para:

- Romantica 4,5 - Rosa - Rosa Reverse - Rosa Sinistra Reverse - Sovrana Evo 2.0 - Sovrana Easy Evo - TermoRosa - TermoSovrana - Family 4,5



Kit griglia mobile Rosa  
 Rosa high-adjustable grate  
 Kit grille mobile Rosa  
 Kit beweglicher Rost Rosa  
 Kit rejilla móvil Rosa

Kit griglia mobile Rosetta  
 Rosetta high-adjustable grate  
 Kit grille mobile Rosetta  
 Kit beweglicher Rost Rosetta  
 Kit rejilla móvil Rosetta

Kit griglia mobile Rosetta Sinistra  
 Rosetta Sinistra high-adjustable grate  
 Kit grille mobile Rosetta Sinistra  
 Kit beweglicher Rost Rosetta Sinistra  
 Kit rejilla móvil Rosetta Sinistra



## ACCESSORI CUCINE E TERMOCUCINE



Kit centrino levigato completo di due coperchi in ghisa smaltata vetrificata antracite. Disponibile per:  
 Plates with Enamelled Polished plate with 2 black Enamelled vitrified iron coversast iron top plates for:  
 Kit plaque de cuisson en fonte polie avec 2 couvercles en fonte émaillée vitrifiée noir. Disponible pour:  
 Satz geschliffene Herdplatte mit 2 schwarzen emailierten glasierten Gussdeckeln. Erhältlich für:  
 Kit plata con arandelas con 2 tapas en fundición esmaltada vitrificado negra. Disponible para:

- Suprema
- TermoSuprema



Kit Coperchio, Disponibile per:  
 Cover kit. Available for:  
 Kit couvercle. Disponible pour:  
 Bausatz Abdeckplatte. Erhältlich für:  
 Kit tapa. Disponible para:

- Sovrana Easy Evo
- Family 4,5
- Family 3,5



Fianchi per installazione uscita fumi laterale. Disponibile per:  
 Flanks for side smoke outlet installation. Available for:  
 Côtés pour l'installation de sortie des fumées latérale. Disponible pour:  
 Seitenteile für die Installation des seitlichen Rauchgasaustritts. Erhältlich für:  
 Laterales para la instalación de salida de humos lateral. Disponible para:

- Vicenza Evo
- Verona
- Verona XXL
- Padova



Top con altezza 4 cm. Disponibile per:  
 Top with 4 cm height. Available for:  
 Top de 4 cm de haut. Disponible pour:  
 Oberteil mit Höhe 4 cm. Erhältlich für:  
 Revestimiento con altura de 4 cm. Disponible para:

- Vicenza Evo
- Verona
- Verona XXL
- Padova



Kit piano Vetroceramico. Disponibile per:  
 Ceramic glass top kit. Available for:  
 Kit plan vitrocéramique. Disponible pour:  
 Bausatz Glaskeramikfläche. Erhältlich für:  
 Kit plano de vitrocerámica. Disponible para:

- Vicenza Evo
- Verona
- Verona XXL
- Padova
- Rosa L



## ACCESSORI

Spugnetta Dry Wiper / Dry Wiper sponge / Éponge Dry Wiper / Dry Wiper Schwamm / Esponja dry wiper

Speciale per la pulizia a secco del vetro ceramico di stufe e camini.  
 Confezione completa di 14 spugnette Dry Wiper  
 Specific for cleaning the ceramic glass of stoves and fireplaces without water.  
 Pack containing 14 Dry Wiper sponges  
 Spéciale pour le nettoyage à sec de la vitre céramique des poêles et des cheminées.  
 Boîte complète de 14 éponges Dry Wiper  
 Speziell für die Trockenreinigung von Glaskeramikfenstern an Öfen und Kaminen.  
 Packung, komplett mit 14 Dry Wiper Schwämmen  
 Especial para la limpieza en seco del cristal cerámico de estufas y chimeneas.  
 Caja con 14 esponjas dry wiper



WindFire

Accenditore a gas e soffiatore d'aria elettrico alimentato a batterie.  
 Gas igniter and battery-powered electric air blower.  
 Allumeur à gaz et soufflerie d'air électrique alimentée par batterie.  
 Gasanzünder und elektrisches, mit Batterien gespeistes Luftgebläse.  
 Encendedor de gas y soplador de aire eléctrico con baterías.



Spazzacamino, accessorio per la pulizia di stufe, camini e barbecue  
 Chimney Sweep, accessory for cleaning stoves, fireplaces and barbecues  
 Ramoneur, accessoire pour le nettoyage des poêles, des cheminées et des barbecues  
 Asche-Staubsauger, Zubehörteil für die Reinigung von Öfen, Kaminen und Barbecues  
 Deshollinador, accesorio para la limpieza de estufas, chimeneas y barbacoas



Espositore completo di 12 Spazzacamino  
 Palbox with 12 pieces Ash-cleaner  
 Palbox avec 12 unités Spazzacamino  
 Palbox mit 12 Stücke Asche-Staubsauger  
 Expositor completo de 12 deshollinadores

Bomboletta spray antracite 600° C senotherm 400 ml  
 Anthracite 600° senotherm ml 400 spray can  
 Bombe de peinture spray anthracite 600° Senotherm 400ml  
 Spraydose Anthrazit 600° Senotherm 400 ml  
 Spray negro 600° Senotherm 400ml



Schermo di calore posteriore per la stufa Marlena  
 Rear heat shield for wood stove Marlena  
 Plaque de protection chaleur postérieure pour le poêle Marlena  
 Rück Hitzeschutzschirm für Marlena  
 Pantalla de protección posterior contra el calor para estufa Marlena



Pedana in acciaio verniciato / Painted steel platform / Plaque de sol en acier peinte  
 Bodenplatte aus lackiertem Stahl / Plataforma de acero barnizado  
 1000x900x2.5 mm  
 900x800x2.5 mm  
 700x600x2.5 mm



Pedana Crystal Nera/ Crystal black platform / Plaque de sol crystal noir /  
 Schutzplatte Crystal Schwarz / Plancha-pedana Crystal  
 990x900x8 mm  
 900x800x8 mm  
 700x600x8 mm



Pedana Crystal Nera/ Crystal black platform / Plaque de sol crystal noir /  
 Schutzplatte Crystal Schwarz / Plancha-pedana Crystal



ø 1000x8 mm

## ACCESSORI FUMISTERIA

Kit serrandola per camino ø 200 mm  
 Damper ø 200 mm  
 Registre pour cheminée ø 200 mm  
 Kamin Dämpfer ø 200 mm  
 Regulador para hogar ø 200 mm

Kit serrandola per camino ø 250 mm  
 Damper ø 250 mm  
 Registre pour cheminée ø 250 mm  
 Kamin Dämpfer ø 250 mm  
 Regulador para hogar ø 250 mm



Raccordo anticondensa / Anti-condensation fitting / Raccord anti-condensation /  
 Antikondensationsanschlussstück / Racor anticondensación  
 2 mm Ø 120 mm  
 2 mm Ø 130 mm  
 2 mm Ø 150 mm  
 2 mm Ø 160 mm  
 2 mm Ø 200 mm  
 2 mm Ø 250 mm



Tubo / Pipe / Tuyau / Rohr / Tubo

Ø 160 mm - lunghezza: 1000 mm - spessore: 1,2 mm  
 Ø 160 mm - lunghezza: 500 mm - spessore: 1,2 mm  
 Ø 160 mm - lunghezza: 250 mm - spessore: 1,2 mm



Tubo telescopico Ø 160 mm spessore 1,2 mm  
 Telescopic pipe Ø 160 mm 1.2 mm thick  
 Tuyau télescopique Ø 160 mm épaisseur 1,2 mm  
 Teleskoprohr Ø 160 mm Stärke 1,2 mm  
 Tubo telescópico Ø 160 mm espesor 1,2 mm



Curva 90° Ø 160 mm spessore 1,2 mm  
 Curve 90° Ø 160 mm Thickness 1,2 mm  
 Coude 90° Ø 160 mm épaisseur 1,2  
 Rohrbogen 90° Ø 160 mm Stärke 1,2  
 Curva 90° Ø 160 mm espesor 1,2



Rosone Ø 160 mm  
 Rosette Ø 160 mm  
 Rond Ø 160 mm  
 Rosette Ø 160 mm  
 Rosetón Ø 160 mm



Anello Ø 160 mm  
 Ring Ø 160 mm  
 Anneau Ø 160 mm  
 Ring Ø 160 mm  
 Aro Ø 160 mm





Verifica - Check - Vérifier - Prüfen Sie - Compruebe

Scegli - Choose - Choisir - Wählen Sie -Elija

**1 Canna Fumaria**

È l'elemento fondamentale per lo smaltimento dei fumi, deve essere costruita con materiali idonei alle alte temperature, possibilmente di forma circolare, con altezza minima senza curve di 4 metri.

**Flue Pipe**  
Should be considered as the main element for smoke disposal. It must be built with material able to resist to high temperature, better with a circular shape, and 4 meters as minimal height without bends.

**Conduit de fumée**  
C'est un élément essentiel pour l'évacuation des fumées, il doit être réalisé avec des matériaux résistant aux hautes températures, être si possible de section circulaire, et avoir une hauteur minimum sans coudes de 4 mètres.

**Rauchabzug**  
Das grundlegende Element für die Rauchableitung muss aus für hohe Temperaturen geeigneten Materialien möglichst in runder Form und mit einer Mindesthöhe von 4 m ohne Biegungen hergestellt werden.

**Humero**  
Es el elemento fundamental para la eliminación de los humos, debe construirse con materiales adecuados para las altas temperaturas, posiblemente de forma circular y con una altura mínima sin curvas de 4 metros.



Foto a solo scopo dimostrativo  
Picture for illustrative purposes only.  
Photo fournie uniquement à titre d'illustration.  
Foto nur zur Veranschaulichung.  
Foto meramente indicativa.

**2 Condotto di collegamento dei fumi**

Per collegare il camino o la stufa alla canna fumaria il condotto deve avere un percorso il più breve possibile, con pochissimi tratti orizzontali e dello stesso diametro del collarino di attacco al camino.

**Connection Pipe flue**  
Appliance flue connection pipe must be shortest, with few horizontal parts as possible and with the same diameter of the collar pipe appliance connection.

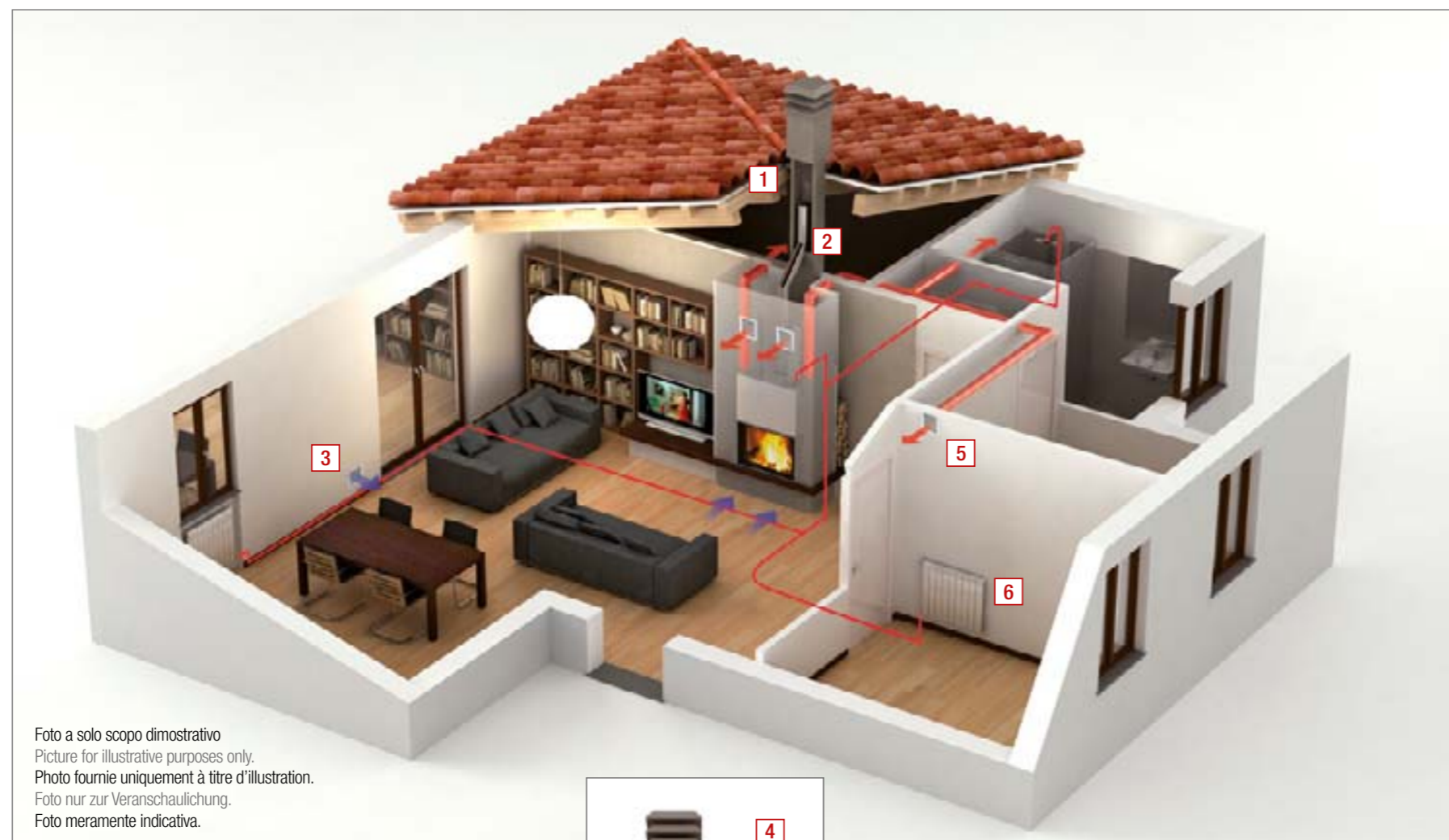
**Conduit de raccordement**  
Il permet de raccorder la cheminée ou le poêle au conduit de fumée; son parcours doit être le plus court possible, avec très peu de tronçons horizontaux et son diamètre doit être égal à celui de la buse de raccordement.

**Rauchrohrverbindungsleitung**  
Die Leitung für die Verbindung des Kamins oder Ofens mit dem Rauchabzug

muss so kurz wie möglich sein, darf nur wenige horizontale Abschnitte aufweisen und muss über den gleichen Durchmesser wie der Befestigungsring für den Kamin verfügen.

**Conducto de conexión de los humos**  
Para conectar la chimenea o la estufa al humero el conducto debe tener un recorrido lo más corto posible, con poquísimos tramos horizontales y del mismo diámetro que el collarín de conexión a la chimenea.

**3 Prese d'aria**  
Verificare l'esistenza di una presa d'aria esterna di dimensioni opportune a garantire una completa ed efficiente combustione è una condizione necessaria per l'installazione di una stufa o camino.

**Air Intake**  
It should be checked as correct appliance installation if do exist an external air intake big enough to offer a whole and efficient combustion.

**Prises d'air**  
Une prise d'air extérieure de section adaptée, permettant d'assurer une combustion complète et efficace, est indispensable pour l'installation d'un poêle ou d'une cheminée.

**Lufteintritt**  
Eine externe Luftzufuhr mit geeigneter Größe, um die vollständige, effiziente Verbrennung zu garantieren, ist eine unverzichtbare Voraussetzung für die Installation eines Ofens oder Kamins.

**Tomas de aire**  
Antes de instalar una estufa o una chimenea debe comprobarse la existencia de una toma de aire externa, de dimensiones adecuadas, para garantizar una combustión completa y eficiente.

**4 Comignolo**  
Posto alla sommità del camino deve avere sezione interna pari a quella del camino, la sezione d'uscita deve essere il doppio rispetto al diametro



della canna fumaria per garantire lo smaltimento dei residui di combustione proteggendo dagli agenti atmosferici (es. vento) o corpi estranei.

**Chimney**  
Put on the top, it must have the same internal section of the chimneypot, while the exit one must be twice compared to the flue pipe diameter to guarantee the residual combustion disposals and protecting against environment.

**Souche de cheminée.**  
Placée au sommet du conduit de cheminée elle doit avoir une section intérieure égale à celle du conduit de cheminée, la section de sortie doit être

égale à deux fois le diamètre du conduit de fumée pour garantir une bonne évacuation des résidus de combustion tout en protégeant des intempéries (ex. vent) ou des corps étrangers.

**Schornstein**  
Befindet sich am Ende des Kamins und muss über den gleichen Innendurchmesser wie der Kamin verfügen; der Austrittsdurchmesser muss doppelt so groß wie der des Rauchabzugsrohrs sein, um den Abzug der Verbrennungsrückstände zu gewährleisten und dabei den Kamin vor Witterungseinflüssen (z. B. Wind) oder Fremdkörpern zu schützen.

**Remate de chimenea**  
Situado en la parte superior de la chimenea debe tener una sección igual a la de ésta, la sección de salida debe ser el doble que el diámetro del humero para garantizar la eliminación de los residuos de combustión protegiendo de los agentes atmosféricos (p.ej. viento) o cuerpos extraños.

**5 La Canalizzazione**

È importante sempre valutare le distanze massime canalizzabili del prodotto installato.

**Canalization**  
It is always important to assess the maximum air-ductable distances of the installed product.

**Système de gaines**  
Il est important de déterminer la longueur maximale des gaines en fonction de l'appareil installé.

**Verlegung**  
Es ist immer wichtig, die maximalen Entfernungen, die das installierte Produkt erlaubt, zu überprüfen.

**La Canalización**  
Es importante valorar siempre las distancias máximas canalizables del producto instalado.

**6 Termoprodotti**

La scelta del termoprodotto da installare va fatta secondo specifiche esigenze individuali valutando minuziosamente la potenza termica complessiva necessaria all'impianto di riscaldamento ed il luogo di installazione.

**Thermo products**  
By choosing what thermo product to install, specific individual needs have to be considered in addition to a meticulous assess of the global thermal power needed by the heating system and of the installation place.

**Appareils de chauffage**  
L'appareil de chauffage doit être choisi en fonction des exigences spécifiques et en déterminant minutieusement la puissance thermique nécessaire et l'endroit où il doit être installé.

**Thermoprodukte**  
Die Wahl des zu installierenden Thermoprodukts muss nach den speziellen individuellen Ansprüchen getroffen werden, wobei die erforderliche Gesamtwärmeleistung für die Heizanlage und der Installationsstandort genauestens abzuwägen sind.

**Productos térmicos**  
La elección del producto térmico que instalar se realiza según las necesidades específicas individuales, valorando minuciosamente la potencia calorífica total necesaria en la instalación de calefacción y el lugar donde va situada.

camino o stufa da installare. Solo in questo modo è possibile quantificare il calore necessario per riscaldare l'ambiente.

**m³ that can be heated**  
The data is indicative. For the generator to be sized correctly, contact a skilled technician/designer. The total volume to heat, the thermal building insulation grade, the sun exposure and the climatic zone have to be determined in order to make the best choice about the fireplace or stove to install. This is the only way to quantify the environmental needed heat.

**m³ chauffables**  
La donnée est indicative. Pour le dimensionnement correct du générateur, il est nécessaire de s'adresser à un technicien/concepteur agréé. Pour bien choisir la cheminée ou le poêle à installer il est nécessaire de déterminer le volume global à chauffer, le niveau d'isolation du bâtiment, l'exposition au soleil et la zone climatique. Cela permet de calculer la quantité de chaleur nécessaire pour chauffer la pièce.

**Beheizbare m³**  
Es handelt sich um einen Richtwert. Für eine korrekte Bemessung des Wärmeezeugers sind ein zugelassener Techniker bzw. Planer zu kontaktieren. Für die optimale Wahl des zu installierenden Kaminofens oder Ofens sind das zu beheizende Gesamtvolumen, die Isolation des Gebäudes, dessen Ausrichtung und die Klimazone zu berücksichtigen. Nur so kann die notwendige Wärmemenge für die Beheizung der Räume ermittelt werden.

**m³ calefactables**  
El valor es aproximado. Para un correcto dimensionamiento del generador, es necesario ponerse en contacto con un técnico o un proyectista habilitado. Es necesario determinar el volumen total que debe calentarse, el grado de aislamiento de la construcción, las exposiciones al sol y a que zona climática pertenece para realizar la elección óptima de la chimenea o estufa a instalar. Sólo así puede cuantificarse el calor necesario para calentar el lugar.

**7 m³ Riscaldabili**

Il dato è indicativo. Per un corretto dimensionamento del generatore è necessario rivolgersi ad un tecnico/progettista abilitato. È necessario determinare il volume complessivo che deve essere riscaldato, il grado di isolamento della costruzione, le esposizioni verso il sole e la zona climatica di appartenenza per la scelta ottimale del

Potenza nominale kW Nominal power kW Puisissance nominale kW Nominalleistung in kW Potencia nominal kW	m³ riscaldabile m³ to heat Surface chauffable m³ Beheizbare m³ m³ Calentables
5 - 8	150 - 200 circa
8 - 12	200 - 300 circa
12 - 20	300 - 500 circa

Riferito al fabbisogno di 30 kcal/h x m³  
Referred to the need of 30 kcal/h x m³  
Par rapport à un besoin de 30 Kcal/h x m³

Bezogen auf einen Bedarf von 30 Kcal/h x m³  
Referido a la necesidad de 30 kcal/h x m³

N.B.: I prodotti La Nordica devono essere collegati a canne fumarie con un tiraggio compreso tra 10 Pa e 17 Pa, come riportato nel libretto d'istruzioni in dotazione ad ogni prodotto. I termoprodotto devono essere collegati a canne fumarie con tiraggio compreso tra 17 Pa e 20 Pa.

Note: La Nordica products must be connected to chimneys having a draught between 10 Pa and 17 Pa as indicated by the instruction manual which is supplied along with any product. The Thermoproducts must be connected to chimneys with a draught between 17 Pa and 20 Pa.

Attention: Les produits La Nordica doivent se raccorder à conduits de fumées avec un tirage entre 10-17 Pa, comme indiqué sur les manuels d'instruction que Vous trouvez sur chaque appareil. Les Thermoproducts doivent se raccorder à conduits de fumées avec un tirage entre 17-20 Pa.

Achtung: Der Unterdruck im Schornstein soll für La Nordica Produkte zwischen 10-17 Pascal betragen, wie in unserer Bedienungsanleitung gezeigt ist. Der Unterdruck im Schornstein für die Thermoproducte soll zwischen 17-20 Pascal betragen.

Nota: los productos La Nordica tienen que ser conectados a los conductos de humos con un tiro entre 10 Pa y 17 Pa como está indicado por el manual de instrucción en el equipamiento base de cada producto. Los termoproductos tienen que ser conectados a los conductos de humo con un tiro entre 17 Pa y 20 Pa.

La riproduzione dei colori è indicativa, in quanto stampati. - Due to printing reasons the reproduction of colours has to be considered only indicative. - La reproduction des couleurs est indicative, car imprimées. - Die gezeichneten Farben sind wegen Druckgründe nur ein Beispiel. - La reproducción de los colores es indicativa en cuanto impresos.

Le maioliche "La Nordica-Extrafame" sono prodotti di alta fattura artigianale e come tali possono presentare micropuntature e piccole imperfezioni sulla superficie. Queste stesse piccole caratteristiche ne testimoniano la pregiata natura. - "La Nordica-Extrafame" majolicas are handmade high-quality products and therefore they present crackles, speckles and shadings. These characteristics certify their precious origin. - Les faïences "La Nordica-Extrafame" sont des produits de haute facture artisanale et comme tels elles peuvent présenter des micro-piqûres et des petites imperfections sur la surface. Ces petites caractéristiques en témoignent leur grande valeur. - Die Majolika-Fliesen „La Nordica-Extrafame“ sind hochwertige handwerkliche Produkte und können als Zeichen dessen kleine Punkte und Unregelmäßigkeiten auf der Oberfläche aufweisen. Diese Eigenschaften zeugen von ihrer wertvollen Herkunft. - Las mayólicas "La Nordica-Extrafame" son unos productos de alta elaboración artesanal y, como tales, pueden presentar pequeños puntos e imperfecciones en la superficie. Estas minúsculas características dan fe de su valor.

I prodotti La Nordica ed Extrafame possono essere coperti da privative industriali (come ad es. brevetti, design e marchi) di proprietà esclusiva La Nordica ed Extrafame. È fatto divieto violare tali diritti come pure divieto rimuovere, sopprimere o alterare i marchi apposti ai prodotti e di apporne altri. - The La Nordica-Extrafame products can be covered by industrial property rights (such as patents, designs and trademarks) owned by La Nordica-Extrafame exclusively. It is strictly forbidden to violate these rights as for removing, cancelling or corrupting the trademarks impressed on the products and impressing others. - Les produits "La Nordica ed Extrafame" peuvent être protégés par un monopole industriel (ex.: brevets, designs et marques) appartenant exclusivement à La Nordica-Extrafame. Il est strictement interdit de violer ces droits tout comme il est interdit d'enlever, de supprimer ou altérer les marques des produits et d'en ajouter d'autres. - Die Produkte „La Nordica und Extrafame“ können mit industriellen Schutzrechten (wie z.B. Patente, Designs und Markennamen) belegt sein, die ausschließliches Eigentum von La Nordica-Extrafame sind. Die Verletzung dieser Rechte sowie die Entfernung, Behinderung oder Veränderung der auf den Produkten angebrachten Markenzeichen und das Anbringen von anderen Markenzeichen ist untersagt. - Los productos "La Nordica-Extrafame" pueden estar protegidos por derechos industriales (como patentes, diseño y marcas) de propiedad exclusiva La Nordica-Extrafame. Se prohíbe violar dichos derechos, al igual que quitar, suprimir o alterar las marcas que figuran sobre el producto y poner otras.

Prima dell'acquisto, richiedete al Vostro rivenditore tutte le informazioni relative all'apparecchio. Inoltre è necessario tenere in considerazione anche tutte le leggi e le normative nazionali, regionali, provinciali e comunali presenti nel paese in cui sarà installato l'apparecchio, nonché delle istruzioni contenute nel manuale d'uso. - Before the purchase, ask to your reseller all the information regarding the appliance. One must also bear in mind all laws and national, regional, provincial and town council Standards present in the country in which the appliance has been installed, as well as the instructions contained in this manual. - Avant l'achat, demandez à Votre revendeur toutes les informations qui regardent l'appareil. Il faut respecter toutes les lois et réglementations nationales, régionales, provinciales et communales existant dans le pays où a été installé l'appareil, ainsi que les instructions contenues dans le présent manuel. - Bevor dem Einkauf, fordern Sie Ihrem Verkäufer alle Informationen hinsichtlich des Gerätes wieder. Beachtet werden müssen auch sämtliche Gesetze und Vorschriften, die auf Landes-, Regional-, Provinz- und Gemeindeebene in dem Land gelten, in dem das Gerät installiert wird, sowie die in diesem Handbuch enthaltenen Anweisungen. - Antes de la compra, solicitar al vuestro revendedor todas las informaciones respecto de l'aparato. Es necesario considerar también todas las leyes y las normativas nacionales, regionales, provinciales y municipales presentes en el país en el que se instala el equipo, además de las instrucciones contenidas en el presente manual.

Le immagini contenute nel presente documento sono da considerare solo rappresentative della parte estetica del prodotto, non costituiscono quindi indicazioni per le prestazioni o le caratteristiche tecniche dello stesso. - The images contained in this document are for product illustration purposes only and do not represent indications for the performance or technical characteristics of the same. - Les images contenues dans le présent document doivent être considérées comme purement représentatives de l'aspect esthétique du produit et ne constituent donc pas des indications relatives aux performances ou aux caractéristiques techniques de ce dernier. - Die Abbildungen im vorliegenden Handbuch sind nur als exemplarische Ansichten gedacht, sie geben daher keine Angaben zu den Leistungen oder technischen Eigenschaften des Produktes. - Las imágenes incluidas en el presente documento son meramente indicativas de la parte estética del producto y, por lo tanto, no dan indicaciones del rendimiento ni de las características técnicas del mismo.

Tutti i dati sono rilevati usando pellet omologato secondo normative EN ISO 17225-2. - All the figures were measured using approved pellets in compliance with EN ISO 17225-2. - Toutes les données sont relevées en utilisant des pellets homologués conformément aux normes EN ISO 17225-2. - Alle Angaben sind unter Einsatz von laut EN ISO 17225-2 homologierten Pellet festgestellt worden. - Todos los datos han sido relevados utilizando gránulos homologados según las normativas EN ISO 17225-2.

Le ambientazioni visibili nelle foto, sono state realizzate con l'impiego di pavimentazioni in materiale ignifugo. La ditta si riserva di apportare le modifiche che riterrà più opportune senza darne preavviso, per esigenze tecniche o commerciali, e non si assume responsabilità per eventuali errori e inesattezze sul contenuto del catalogo. I dati e le misure forniti hanno valore puramente indicativo. Tutte le immagini e loro diritti appartengono in via esclusiva a La Nordica S.p.A. Tutti i diritti sono riservati. - The interiors illustrated in the photographs were created using fireproof flooring. The company reserves the right to introduce the technical or commercial changes it holds to be opportune without giving prior notice. The company shall not be responsible for any errors or mistakes in the contents of the catalogue. Data and dimensions that are provided are for an indication only. All images and their rights are the exclusive property of La Nordica S.p.A. All rights reserved. - les décors visibles sur les photos ont été réalisés avec des revêtements de sol en matériel ignifuge. La firme se réserve le droit d'apporter les modifications qu'elle estimera opportunes, sans préavis, pour des exigences techniques ou commerciales. Elle dégage toute responsabilité pour des erreurs et des inexactitudes éventuelles contenues dans le catalogue. Les données et les dimensions fournies sont purement indicatives. Toutes les images et leurs droits appartiennent exclusivement à La Nordica S.p.A. Tous droits réservés. - Die aus den Fotos ersichtlichen Ambiente wurden mit Bodenbelägen aus feuerfestem Material realisiert. Die Firma behält sich vor, nach eigenem Ermessen ohne Ankündigung Änderungen technischer oder geschäftlicher Art anzubringen. Für eventuelle Fehler oder Ungenauigkeiten, was den Kataloginhalt angeht, wird keine Haftung übernommen. Daten und Maßangaben sind nicht verbindlich. Alle Abbildungen und betreffenden Rechte gehören ausschließlich der La Nordica A.p.A. Alle Rechte vorbehalten. - Las decoraciones visibles en las fotografías han sido realizadas por la colocación de unas pavimentaciones en material ignifugo. La empresa se reserva el derecho de introducir las modificaciones que reputa más oportunas, sin previo aviso, para exigencias técnicas o comerciales, y rehúsa cualquier responsabilidad por los eventuales errores y equivocaciones contenidos en el catálogo. Los datos y medidas que se suministran tienen valor únicamente aproximado. Todas las imágenes y los derechos pertenecen en exclusiva a La Nordica S.p.A. Todos derechos reservados.

I materiali lapidei naturali, come la pietra ed il marmo, per propria essenza sono soggetti a variazioni estetiche di tono, colore e venatura sia tra un pezzo e l'altro che rispetto ad un campione visto. Eventuali differenze sono quindi da considerare caratteristiche peculiari ed elementi distintivi del materiale stesso che ne certificano l'unicità, valore assoluto di questo tipo di prodotto. - Due to its nature, natural stone material, such as marble, is subject to aesthetic variations in shade, colour and grain pattern when comparing one piece to another and also to a sample. Therefore, any differences are to be considered particular characteristics and distinctive elements of the material itself that certify the uniqueness, which is the absolute value of this type of product. - Les matériaux pierreux naturels tels que la pierre et le marbre sont sujets de par leur nature à des variations esthétiques de ton, de couleur et de veinage, aussi bien d'une pièce à l'autre que par rapport à un échantillon de référence. Les éventuelles différences doivent donc être considérées comme des caractéristiques particulières et des éléments distinctifs du matériau qui attestent son unicité, valeur absolue de ce type de produit. - Naturmaterialien wie Stein und Marmor können aufgrund ihres Wesens in ihrer Beschaffenheit, dem Farbton und der Maserung unterschiedlich sein und von dem gesehenen Muster abweichen. Mögliche Unterschiede sind daher als besondere Eigenschaften und Unterscheidungsmerkmale des Materials selbst anzusehen, die seine Einzigartigkeit bescheinigen und den absolute Wert dieser Produktart ausmachen. - Los materiales lapídeos naturales, como la piedra y el mármol, por su esencia pueden sufrir cambios estéticos de tono, color y vetadoo, ya sea entre dos piezas que respecto a una muestra vista. Las diferencias se deben por lo tanto considerar como características peculiares y elementos de distinción del mismo material, que certifican la excepcionalidad, valor absoluto de este tipo de producto.

Trademark e copyright: Tutti i marchi, immagini, informazioni, fotografie, prodotti, pubblicità ed altri segni distintivi presenti nel catalogo sono di proprietà esclusiva di La Nordica S.p.A. - Trademark and copyright: All brands, pictures, information and photos, products, advertisements and all other features displayed in this catalogue are the exclusive property of La Nordica S.p.A. - Trademark et copyright: toute marque, image, information, photographie, produit, publicité et d'autre signe distinctif dans le catalogue sont propriété exclusive La Nordica S.p.A. - Trademark and Copyright: Alle Marken, Bildern, Informationen, Fotos, Produkte, Werbung und andere Unterscheidungszeichen im Katalog sind das ausschließliche Eigentum von La Nordica S.p.A. - Marcas y derechos de autor: Todas las marcas comerciales, imágenes, información, fotografías, productos, publicidad y otros signos distintivos en el catálogo son propiedad exclusiva de La Nordica S.p.A.

I dati presenti nel catalogo possono essere arrotondati al primo decimale. - The data in the catalogue can be rounded off to the first decimal. - Les données du catalogue peuvent être arrondies à la première décimale. - Die Daten im Katalog können auf die erste Dezimalstelle gerundet werden. - Los datos presentes en el catálogo pueden redondearse al primer decimal.

# LEGENDA

Legend / Legende / Zeichenerklärung / Leyenda

## ENERGY LABEL

A partire dal 1 Gennaio 2018 è in vigore l'etichettatura energetica anche per tutti i generatori di calore per il riscaldamento a biomassa con o senza la produzione di acqua calda. Questa indicazione, basata su direttive e regolamenti dell'Unione Europea, assegna una classe di merito (da G ad A++) e consente ai clienti scelte informate sulla base dei consumi e dell'efficienza.

From 1st January 2018 the Energy Labelling Regulation comes into force also for all the biomass heating appliances, both roomheater appliances and appliances designed to heat the water for central heating and domestic hot water. This directive, in accordance with the regulations of the European Union, will assign an Energy Efficiency Class (from G up to A++) providing the buyers with information about the consumption and the efficiency.

A partir du 1er Janvier 2018, l'étiquetage énergétique est en vigueur également pour tous les générateurs de chaleur pour le chauffage de la biomasse avec ou sans la production d'eau chaude. Cette

indication, basée sur les directives et les règlements de l'Union européenne, attribue une classe de mérite (de G à A++) et permet aux clients de faire des choix éclairés en fonction des consommations et de l'efficacité.

Ab dem 1. Januar 2018 tritt die Energiekennzeichnung auch für alle Wärmeerzeuger für Biomasseheizungen mit oder ohne Warmwassererzeugung in Kraft. Diese auf Richtlinien und Verordnungen der Europäischen Union basierende Indikation weist eine Leistungsklasse (von G bis A++) hin und ermöglicht dem Kunden eine fundierte Entscheidung auf der Basis des Kraftstoffverbrauchs und der Effizienz.

A partir del 1 Enero 2018 está en vigor el etiquetado energético también para todos los calentadores de espacio para la calefacción por biomasa con o sin producción de agua caliente sanitaria. Esta indicación, basada en directivas y reglamentaciones de la Unión Europea, asigna un valor de la escala de clasificación (de G hasta A++) y permite que los clientes elijan siendo informados sobre gastos y eficiencia.

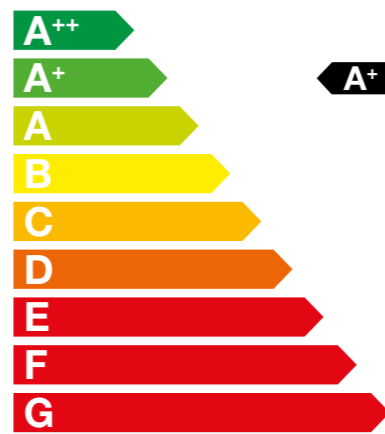

Regolamento Italiano per il rilascio del certificato ambientale per i generatori di calore alimentati a biomasse combustibili solide (classificazione da 1 a 5 stelle)



Aria Pulita, la certificazione volontaria italiana per la qualità dei sistemi di riscaldamento a biomasse legnose (classificazione da 1 a 5 stelle con i medesimi parametri del DM186/2017).



## DATI TECNICI / TECHNICAL DATA / DONNÉES TECHNIQUES / TECHNISCHE DATEN / DATOS TÉCNICOS

	Potenza termica nominale utile (kW) / Nominal thermal power (kW) / Puissance nominale utile (kW) / Nennwärmeleistung (kW) / Potencia nominal útil (kW)		Consumo orario (kg/h) / Hourly consumption (kg/h) / Consommation (kg/h) / Stundenverbrauch (kg/h) / Gasto horario (kg/h)
	Potenza resa al liquido (kW) / Power given back to water (kW) / Puissance rendue a l'eau (kW) / Wasserwärmeleistung (kW) / Potencia suministrada al liquido (kW)		Diametro tubo scarico fumi (mm). S=Superiore, P=Posteriore, Lat.Dx=Laterale Destro, Lat.Sx=Laterale Sinistro / Smoke outlet diameter (mm) S=Top, P=Rear, Lat.Dx=Right side, Lat. Sx=Left side / Diamètre sortie de fumées (mm) S=Au-dessus, P=A l'arriere, Lat.Dx=côté droit, Lat.Sx=côté gauche / Rauchrohrdurchmesser (mm) S=Oberer Rauchanschluss, P=Hinterer Rauchanschluss, Lat.Dx=Seiten, rechts, Lat.Sx=Seiten, links / Dimensiones salida humos (mm) S=Superior, P=Posterior, Lat.Dx=Lateral derecho, Lat.Sx=Lateral izquierdo
	m³ riscaldabili (30 kcal/h x m³) / Heatable m³ (30 kcal/h x m³) / m³ que l'on peut chauffer (30 kcal/h x m³) / Heizungsvermögen m³ (30 kcal/h x m³) / m³ con posibilidad de calefamiento (30 kcal/h x m³)		Dimensioni forno (mm) / Oven size (mm) / Dimensions four (mm) / Abmessungen des Backofens (mm) / Dimensiones horno (mm)
	Dimensioni LxHxP (mm) / Dimensions WxHxD (mm) / Dimensions LxHxP (mm) / Maße BxHxT (mm) / Dimensiones LxAlxA (mm)		Contenuto fluido scambiatore (l) / Fluid contents of the exchanger (l) / Liquide contenu dans l'échangeur (l) / Gehalt Flüssigkeit im Ausstauscher (l) / Contenido fluido intercambiador (l)
	Peso netto (kg) / Net weight (kg) / Poids net (kg) / Netto Gewicht (kg) / Peso Neto (kg)		Pressione d'esercizio (bar) / Working pressure (bar) / Puissance d'exercice (bar) / Arbeitsdruck (bar) / Presión de trabajo (bar)
	Dimensioni bocca fuoco (mm) / Hearth opening size (mm) / Dimensions porte du foyer (mm) / Größe der Feuerraumsöffnung (mm) / Dimensiones boca del hogar (mm)		Assorbimento elettrico (W) / Electric consumption (W) / Absorption électrique (W) / Stromaufnahme (W) / Consumo eléctrico (W)
	Dimensioni focolare (mm) / Hearth size (mm) / Dimensions foyer (mm) / Größe des Feuerraum (mm) / Dimensiones hogar (mm)		Acciaio / Steel / Acier / Stahl / Acero
	Focolare / Hearth / Foyer / Feuerraum / Hogar		Ghisa / Cast-iron / Fonte / Gusseisen / Hierro fundido
	Rendimento (%) / Efficiency (%) / Rendement (%) / Wirkungsgrad (%) / Rendimiento (%)		Refrattario / Refractory / Refractarie / Feuerbeständig Schamotte / Refractorio

## COLORI / COLOURS / COULEURS / FARBEN / COLORES

Ametista	Amethyst	Améthyste	Amethyst	Amatista
Bianco	White	Blanc	Weiss	Blanco
Bianco Infinity	White Infinity	Blanc Infinity	Weiss Infinity	Blanco Infinity
Bordeaux	Burgundy	Bordeaux	Bordeaux	Burdeos
Marrone	Brown	Marron	Braun	Marrón
Crema Opaco	Matt cream	Creme opaque	Matt Cream	Crema opaco
Cappuccino	Cappuccino	Cappuccino	Cappuccino	Cappuccino
Crystal	Crystal	Crystal	Crystal	Crystal
Inox	Inox	Inoxidable	Edelstahl	Inoxidable
Marrone sfumato	Soft brown	Marron nuancé	Verschw. Braun	Marrón esfumado
Madreperla	Mother of pearl	Nacre	Perlmutter	Nacar
Nero antracite	Anthracite black	Noir antracite	Anthrazit-Schwarz	Negro antracita
Nero Lucido	Bright black	Noir brillant	Glänzendes Schwarz	Negro brillante
Oro Craquelé	Gold craquelé	Or craquelé	Gold craquelé	Oro craquelé
Pergamena	Parchment	Parchemin	Pergament beige	Pergamino
Pietra Naturale	Natural stone	Pierre naturelle	Naturstein	Piedra natural
Rustic	Rustic	Rustic	Rustic	Rustic
Silk Vogue Ametista	Silk Vogue Ametista	Silk Vogue Ametista	Silk Vogue Ametista	Silk Vogue Ametista
Twin Color	Twin Color	Twin Color	Twin Color	Twin Color
Titanio	Titanium	Titane	Titan	Titanio
Tortora	Tortora	Tortora	Tortora	Tortora
Verde	Green	Vert	Grün	Verde

PURO CALORE  
MADE IN ITALY

MGA GROUP

Stufa a legna in ghisa smaltata ad alto rendimento termico, modello Jennifer



 **NORDICA**<sup>®</sup>  
**Extraflame**  
Riscalda la vita.

  
SINCE 1968

[www.lanordica-extraflame.com](http://www.lanordica-extraflame.com)



- Il legno è la prima tra le risorse rinnovabili nel mondo.
- L'utilizzo sostenibile della legna non danneggia il bosco ma lo difende.
- I prodotti di ultima generazione abbattano le emissioni fino all'80% rispetto ai vecchi impianti.

“Il Gruppo La Nordica - Extraflame” sostiene il progetto “Italia che rinnova” e ti invita a scoprire tutte le verità sul riscaldamento da biomasse legnose come risorsa fondamentale per le famiglie, per l'ambiente e per l'economia. [italiacherinnova.com](http://italiacherinnova.com)

**La Nordica S.p.A.**  
Via Summano, 104  
36030 Montecchio Precalcino - Vicenza - Italy  
Tel. +39 0445 804000  
Fax +39 0445 804040  
[info@lanordica.com](mailto:info@lanordica.com)  
[www.lanordica-extraflame.com](http://www.lanordica-extraflame.com)